

User Manual

WD-x ADDITIONAL DISPLAY

Manual number:
IMMU-51-01-08-14-ENG



BALANCES AND SCALES

RADWAG 26–600 Radom, Bracka 28, POLAND
Phone +48 48 38 48 800, phone/fax: +48 48 385 00 10
Sales department +48 48 366 80 06
www.radwag.com

AUGUST 2014

Table of Contents

1. GENERAL INFORMATION	4
1.1. Intended use	4
1.2. Precaution measures.....	4
1.3. Warranty conditions.....	5
1.4. The manual's significance	5
2. PACKAGING	6
2.1. Unpacking	6
3. DISPLAY DESIGN	6
4. OPERATION	7
5. TECHNICAL SPECIFICATION	13

1. GENERAL INFORMATION

1.1. Intended use

An additional WD-x series LCD display, with a stand and a plastic housing, is intended for cooperation with either electromagnetic or load cell scales, depending on the display type.

The device displays weighing results. The information presented by means of it and information displayed on the main display of the scales is the same.

Communication with the indicator is established by means of RS232 interface.

1.2. Precaution measures

- A. Before the first use of the display, it is highly recommended to carefully read this User Manual, and operate the device as intended.
- B. Connect the display to disconnected from mains scales. Not complying this requirement may result in incorrect operation or damage of either display or scales.
- C. Clean the display by means of damp cloth.
- D. Do not use any abrasive agents to clean the display, as it may cause damage to the device.
- E. The display may be connected only to scales of RADWAG company production.
- F. Displays to be decommissioned, should be decommissioned in accordance to valid legal regulations.

1.3. Warranty conditions

- A. RADWAG feels obliged to repair or exchange all elements that appear to be faulty by production or their construction,
- B. Defining defects of unclear origin and means of their elimination can only be realized with assistance of manufacturer and user representatives,
- C. RADWAG does not bear any responsibility for defects, losses or accidents resulting from unauthorized or inadequate performing of production or service processes,
- D. Warranty does not cover:
 - Mechanical defects caused by product exploitation other than intended, defects of thermal and chemical origin or defects caused by random event,
 - Display defects if it is utilized contrary to its intended use,
 - Defects caused by cleansers, liquids, water and natural wear,
 - Maintenance activities (cleaning).
- E. Loss of warranty takes place if:
 - A repair is carried out outside RADWAG sales office or authorized service point,
 - Service claims intrusion by unauthorized people,
 - Other than intended use of the display.
- F. Detailed warranty conditions are listed on a service card.
- G. Authorized Service Point phone number: +48 48 384 88 00 ext. 106 and 107.

1.4. The manual's significance

It is very important to read the user manual carefully before the first use of the display, even if the user is experienced and has worked with the this type of device before.

2. PACKAGING

2.1. Unpacking

The display is delivered in a factory packaging. Be careful while unpacking and removing the display out of its packaging.

It is indispensable to store the display in the original packaging if it is not in use.

3. DISPLAY DESIGN

Application:

- Increasing scales functionality.

Design:

WD-x additional display, manufactured in a plastic housing, is characterized by LED backlighting. It may be connected to:

- 3Y series – WD-5/3Y
- R series – WD-6.
- WLY – WD-4/4

Connection is established by means of cable with D-SUB 15 interface (male connector) or D-SUB 9 (female connector). The display is powered from balance. The display features automatic stand-by mode.

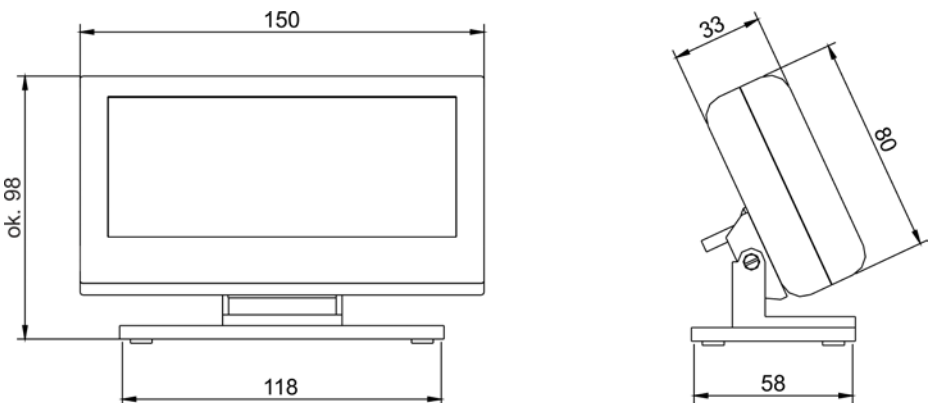

WD-x display dimensions.

4. OPERATION

In order to ensure correct operation of the display it is necessary to satisfy any requirements of this manual. Requirements of a particular balance must be complied as well.

The user must remember to disconnect balance from mains prior connection of the additional display to it.

Upon display connection, the balance may be powered again.

Means of connecting WD-5/3Y display

It is indispensable to set the balance in accordance with the below instruction before performing connection.





Settings for balance cooperation with an external additional display are to be found in <ADDITIONAL DISP.> submenu.

The balance may establish connection with an additional display by means of the following ports:

- RS 232 (COM1),
- RS 232 (COM2),
- Tcp.

It is possible to specify type of displayed information presented on an additional display. To do it go to <Project> parameter.

Designing variable - procedure

- Go to < Peripheral devices > parameters.
- Select „ Additional display /  Project” and wait for <Project> editing window to open; the window is equipped with an on-screen keyboard.
- Use on-screen keyboard to enter the demanded value or press < > button to select the particular value out of a list.
- Press  button to confirm.

Caution:

For correct cooperation with the additional display the variable value for  <Template> parameter shall be {140}, and the baud rate for port to which the additional display is connected 38400 bit/s

Means of connecting WD-6 display

It is indispensable to set the balance in accordance with the below instruction before performing connection.

Settings for balance cooperation with an external additional display are to be found in <ADD DISPLAY> submenu.

Procedure:

- Press  button
- Go to <P4 DEVICES> menu
- Enter <P4.4 ADD DISPLAY> menu
- Set balance parameters for cooperation with an additional display

<P4.4.1 PORT> - selection of a port to which an additional display is to be connected

- possible options: NONE, COM 1, COM 2

Caution:

The balance cooperates with an additional display of RADWAG production. For correct cooperation with the additional display the baud rate for port to which the additional display is connected shall be 115200 bit/s.

Means of connecting WD-4/4 display

An additional display port

The balance may establish communication with an additional display by ports:

- RS 232 (COM1),
- RS 232 (COM2),
- Tcp.

Communication protocol template

WLY series balance may cooperate with a display of WD-4/4 type,

In order to establish communication of the balance with WD-4/4 display it is necessary to enter < **Template**> parameter and define the right communication protocol template.

Procedure:

Following point 16 of the balance user manual go to < **Devices**> parameter group.

Select „ **Additional display** /  **Template**” and wait for <**Template**> editing window to open, the window features on-screen keyboard.

Using on-screen keyboard, enter the demanded template value or press a respective button to select the value out of a list.

Caution:

*For correct cooperation with the additional display the variable value for < **Template**> parameter shall be {141}.*

RS232 pins marking for WD-x display boards:

WD-5/3Y

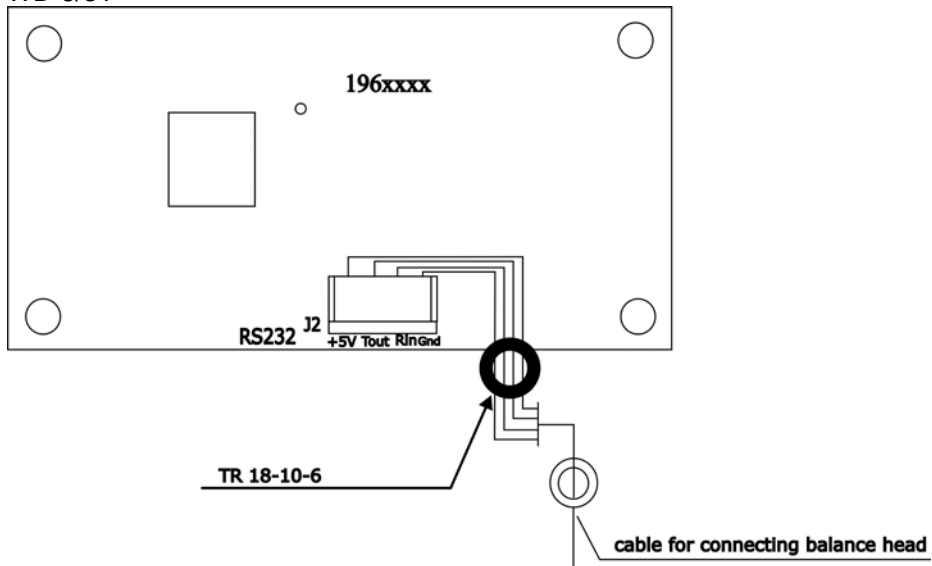

WD-6

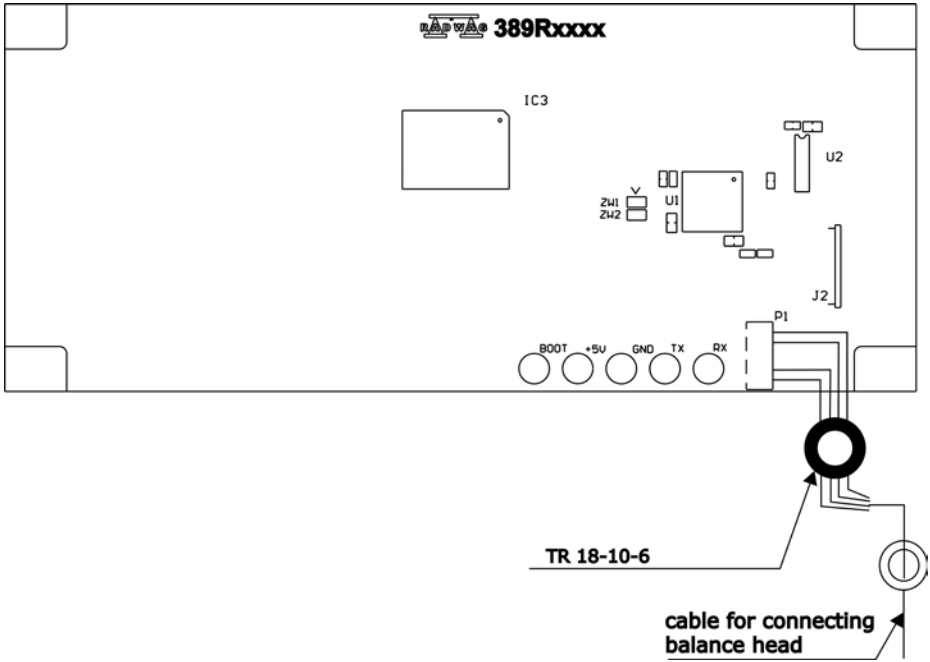

WD-4/4

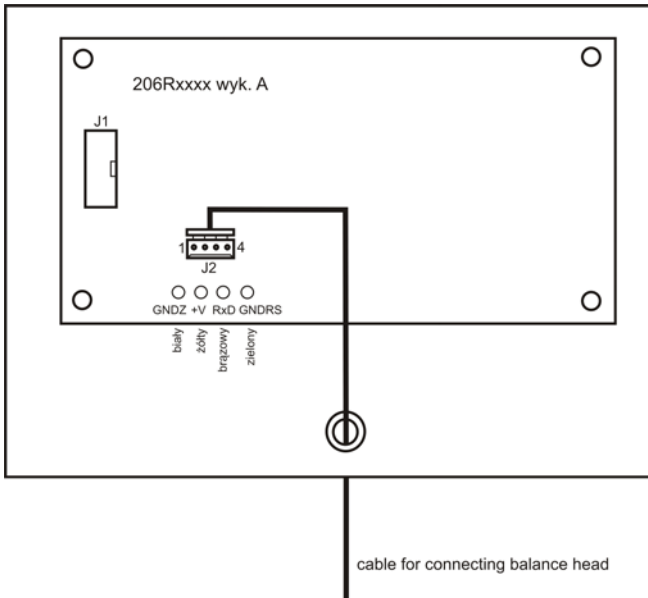

Diagrams of connecting cables for WD-x displays:

WD-5/3Y – cable PWD-3Y

D-Sub 15 pin male connector
In DSC-209 housing, soldering side view

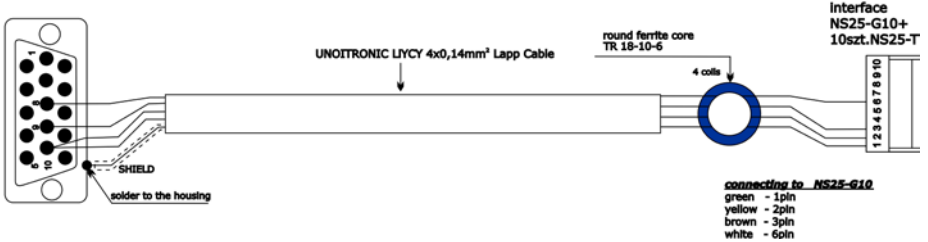

WD-6 – cable PWD-1

D-Sub 9 pin female connector
In DSC-209 housing, soldering side view

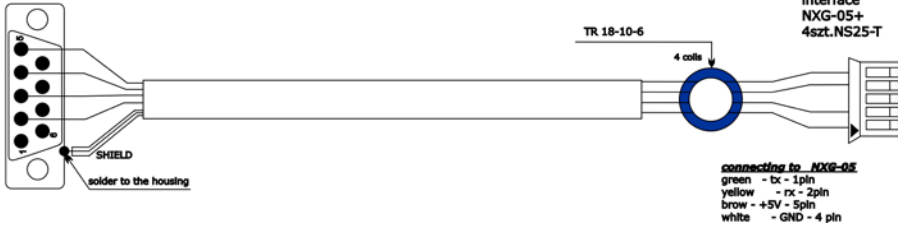

WD-4/4 – cable PT0150

DSUB15/M (male)

for 206Rboox board

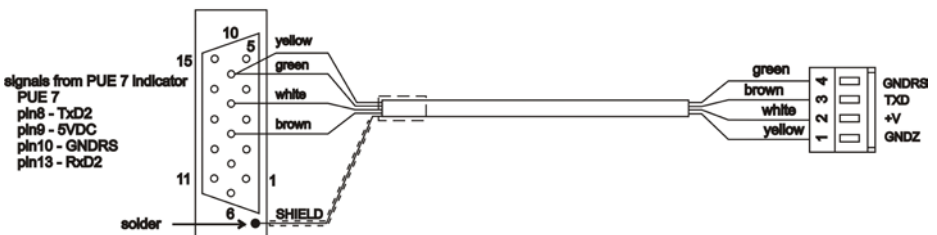

5. TECHNICAL SPECIFICATION

Display type	WD-5/3Y	WD-6	WD4/4
Housing	Plastic		
Digits size	~16,2 mm	~18,2 mm	~16,2 mm
Intended for series	3Y and 4Y	R	WLY (PUE 7)
Communication	RS-232		
Power supply	6V DC from balance indicator		
Means of connecting	D-sub 15pin (male)	D-sub 9pin (female)	D-sub 15pin (male)
Signal cable length:	1,5 m (optionally max 10m)		
IP rate	IP57		
Working temperature	od 0°C do +40°C		
Display housing dimensions (base size excluded)	150 × 80 × 33 *		
Mass (nett value)	~570 g		

* the dimensions exclude cable gland size

MANUFACTURER
OF ELECTRONIC WEIGHING INSTRUMENTS



RADWAG BALANCES AND SCALES
POLAND, 26 – 600 Radom, Bracka 28

Phone. +48 48 38 48 800, fax. + 48 48 385 00 10
Sales department + 48 48 366 80 06
export@radwag.com
www.radwag.com