

TWM1

**1-LOAD-CELL PLATFORM SCALES
4-LOAD-CELL PLATFORM SCALES
PALLET AND BEAM SCALES
RAMP SCALES**

USER MANUAL

ITKU-87-03-03-21-EN











RADWAG®
ADVANCED WEIGHING TECHNOLOGIES

MARCH 2021

PRECAUTIONS

Prior to installation, operation or maintenance activities, carefully read this user manual. Follow the instructions strictly.

	Prior to the first use, carefully read this user manual. Use the device only as intended.
	Place loads in the centre of the weighing pan.
	Load the weighing pan with loads of gross weight which does not exceed the maximum capacity.
	Mind not to leave heavy loads on the weighing pan for longer periods of time.
	Protect the scale against considerable temperature variation, solar and UV radiation, substances causing chemical reactions.
	The scale must not be operated in hazardous areas endangered with explosion of gases, and in dusty environments.
	In the case of damage, immediately unplug the device from the mains.
	The scale to be decommissioned must be decommissioned in accordance with valid legal regulations.
	If the scale is to be operated in conditions that are difficult due to electrostatics (e.g. printing house, packing centre, etc.), you must connect it to the earth wire. To enable this, the device features functional earthing terminal, marked with \perp symbol.

Contents

1. INTENDED USE	5
2. WARRANTY CONDITIONS	5
3. MAINTENANCE	6
3.1. Cleaning Powder-Coated Components.....	6
3.2. Cleaning Stainless Steel Components.....	6
3.3. Cleaning ABS Components.....	6
4. SERVICE AND REPAIR	7
5. RECYCLING	7
6. MECHANICAL DESIGN	7
6.1. 1-Load-Cell Scales	7
6.2. Multiple-Load-Cell Scales.....	8
6.3. Scales with Load-Cell Modules	8
6.4. Dimensions.....	8
6.5. Models	8
6.6. Connectors	8
6.6.1. Profibus Pin Arrangement	8
6.6.2. Diagrams of Connection Cables	9
6.7. Inputs / Outputs	10
6.7.1. Technical Specifications.....	10
6.7.2. Input / Output Signals	10
7. INSTALLATION	11
7.1. Unpacking and Installation	11
7.1.1. 1-Load-Cell Platform Scales of TWM1-x Series	11
7.1.2. Platform Scales of TWM1-x.4.xx.C, TWM1-x.4.xx.H, TWM1-x.4.xx.H/Z Series	11
7.1.3. Ramp Scales of TWM1-x.4N Series	11
7.2. Levelling: 1-Load-Cell Platform Scales	12
7.3. Levelling: 4-Load-Cell Platform Scales	13
7.4. Start-Up	13
8. MwmManager HOME SCREEN	14
9. OPERATING THE MENU	14
10. WEIGHING	15
10.1. Good Weighing Practice: 1-Load-Cell Platform Scales	15
10.2. Good Weighing Practice: Custom Scales.....	16
10.3. Zeroing	17
10.4. Taring	18
10.5. Dual Range Devices.....	18
11. TECHNICAL SPECIFICATIONS	18
12. ERROR MESSAGES	19

1. INTENDED USE

The scales are a response to growing market demands for an instrument offering simplicity of operation and weighing process automated to the maximum. Due to use of the MW-01 mass converter, the scales are a perfect solution for numerous industry applications. The converter features a metal housing, this enables operation in high humidity and vast temperature range, from -10°C to +40°C. It communicates with various devices via the following interfaces: RS232, RS485, Ethernet, Profibus, and Modbus protocol. The TWM1 scale is equipped with 2 optoisolated inputs, 2 reed switch outputs and a high speed transistor output. It is powered by 8÷30VDC mains voltage.

Operation of the TWM1 scale via PC is carried out using **'MwManager'** software. For more information on the **'MwManager'** software read MwManager manual.

2. WARRANTY CONDITIONS

- A. RADWAG is obliged to repair or exchange all elements that appear to be faulty by production or by construction.
- B. Defining defects of unclear origin and means of their elimination can only be realized with the assistance of the manufacturer and the user representatives.
- C. RADWAG does not bear any responsibility for damage or losses resulting from unauthorized or inadequate performing of production or service processes.
- D. The warranty does not cover:
 - mechanical damage caused by product exploitation other than intended, damage of thermal and chemical origin, damage caused by lightning, overvoltage in the power network or other random event,
 - inappropriate cleaning habits.
- E. Loss of warranty takes place if:
 - a repair is carried out outside RADWAG authorized service point,
 - service claims intrusion into mechanical or electronic construction by unauthorized people,
 - the scale does not bear security seal stickers.
- F. Warranty conditions outline the warranty period for rechargeable batteries attached to the device for 12 months.
- G. For detailed warranty conditions read the service card.
- H. Contact with the central authorized service: +48 (48) 386 63 30.

3. MAINTENANCE

In order to clean the weighing instrument risk-free, it is necessary to disconnect the device from the mains. With this condition met, uninstall the weighing pan and other detachable components.

	<p><i>Cleaning the weighing pan while still installed may cause damage of the measuring system.</i></p>
---	--

3.1. Cleaning Powder-Coated Components

Avoid using cleansers containing any corrosive chemicals, e.g. bleach (with chlorine). Do not use cleansers containing abrasive substances. Always remove the dirt using microfiber cloth, do it in order to avoid damage of protective coating. In the case of a daily maintenance:

1. Remove the dirt using cloth dipped in warm water.
2. For best results, add a little bit of dishwashing detergent.

3.2. Cleaning Stainless Steel Components

Avoid using cleansers containing any corrosive chemicals, e.g. bleach (with chlorine). Do not use cleansers containing abrasive substances. Always remove the dirt using microfiber cloth, do it in order to avoid damage of protective coating. In the case of a daily maintenance:

1. Remove the dirt using cloth dipped in warm water.
2. For best results, add a little bit of dishwashing detergent.

3.3. Cleaning ABS Components

To clean dry surfaces and avoid smudging, use clean non-colouring cloths made of cellulose or cotton. You can use a solution of water and detergent (soap, dishwashing detergent, glass cleaner). Gently rub the dirty surface and let it dry. Repeat the cleaning process if necessary.

In the case of hard to remove contamination, e.g. residues of adhesive, rubber, resin, polyurethane foam etc., you can use special cleaning agents based on a mixture of aliphatic hydrocarbons that do not dissolve plastics. Before using the cleanser for all surfaces we recommend carrying out tests. Do not use cleansers containing abrasive substances.

4. SERVICE AND REPAIR



In the case of any sign of damage, it is necessary to disconnect the device from the mains immediately. The damaged component must be replaced or repaired by RADWAG service directly.

In the case of any problems with correct operation of the scale, contact the closest manufacturer's service point.

In the case of defects, deliver the faulty product to the manufacturer's service point. If the product cannot be delivered to the manufacturer's service point, call the service and report the defect. Repair scope and method will be set up.



The user is NOT ALLOWED to carry out any kind of repair of the device himself/herself. Any attempt of scale modification, repair etc., by unauthorized persons, will result with loss of validity of manufacturer-issued certificates, declarations and warranty.

5. RECYCLING

TWM1 scales must be recycled, they are not to be treated as a regular household waste. Scales to be decommissioned must be decommissioned in accordance with valid legal regulations.



6. MECHANICAL DESIGN

6.1. 1-Load-Cell Scales

1-load-cell TWM1 scale is intended to carry out fast and precise mass measurement of up to 300 kg loads. Its characteristic feature is a platform with one load cell only. The platform is equipped with a stainless steel weighing pan. Depending on a scale model, the cross and base are made of either stainless steel or powder-coated steel.

6.2. Multiple-Load-Cell Scales

Multiple-load-cell TWM1 scale is intended to carry out fast and precise mass measurement of large loads. Its characteristic feature is a platform equipped with numerous load cells, usually four. The platform, depending on a scale model, is made of stainless steel or powder-coated steel, it features customized mechanical design suiting particular customer's requirements (pallet, beam, platform scales).

6.3. Scales with Load-Cell Modules

TWM1 scale with load cell modules is intended to carry out mass measurement of silos. Modules are built into construction of ground-fixed silo's support. In most cases, the scale design includes 3-4 load cell modules. The modules, depending on the model, are made of stainless or galvanized steel.

6.4. Dimensions

For overall dimensions read product card of a respective scale, the product cards are to be found on RADWAG website www.radwag.pl.

6.5. Models



TWM1 models:

MODEL	TWM1-1	TWM1-2
Communication interface	RS232, RS485, Ethernet	RS232, PROFIBUS

6.6. Connectors

6.6.1. Profibus Pin Arrangement

On the output connector there is 5 VDC voltage, this provides correct operation of a terminator. M12 5 pin B coded connectors are installed (for PROFIBUS DP).

PROFIBUS IN (male)		Pin1 – NC Pin2 – A Pin3 – NC Pin4 – B Pin5 – NC
PROFIBUS OUT (female)		Pin1 - +5V Pin2 – A Pin3 – GND Pin4 – B Pin5 – NC

6.6.2. Diagrams of Connection Cables

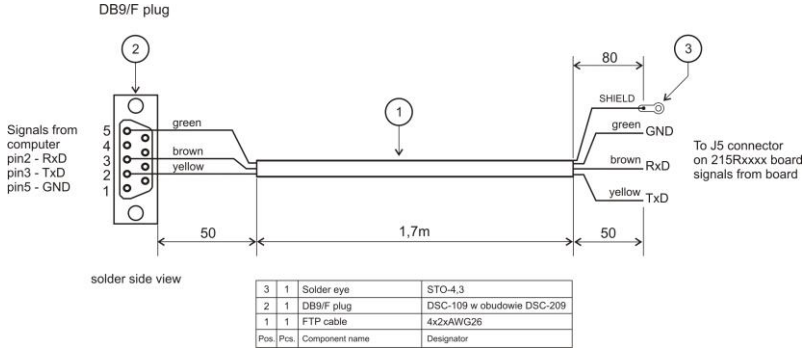

'Mass converter' – 'RS232' cable (PT0145)

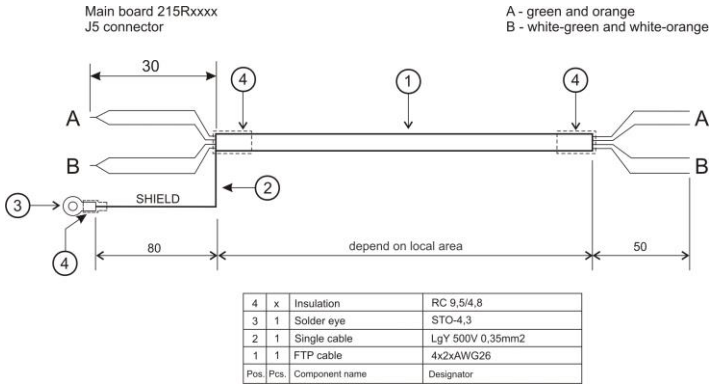

'Mass converter' – 'RS485' cable (PT0012)

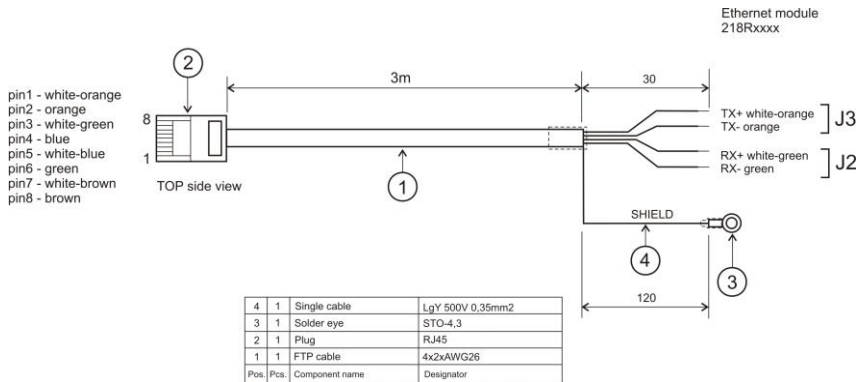

'Mass converter' – 'Ethernet' cable (PT0014)

6.7. Inputs / Outputs

The scale is equipped with 2 optoisolated inputs, 2 reed switch outputs and a high speed transistor output (open collector type).

6.7.1. Technical Specifications

OUT1 – OUT2 Parameters	
Output quantity	2
Output type	reed switch of NO type
Cable cross-section	0.14 - 0.5 mm ²
Maximum output current	200 mA
Maximum output voltage	50 VDC
OUT3 Parameters	
Output quantity	1
Output type	Transistor
U _{max}	5 VDC
I _{max}	100 mA
Input parameters	
Input quantity	2
Input type	Optoisolated
Cable cross-section	0.14 - 0.5 mm ²
Input voltage range	5 – 24 VDC

6.7.2. Input / Output Signals

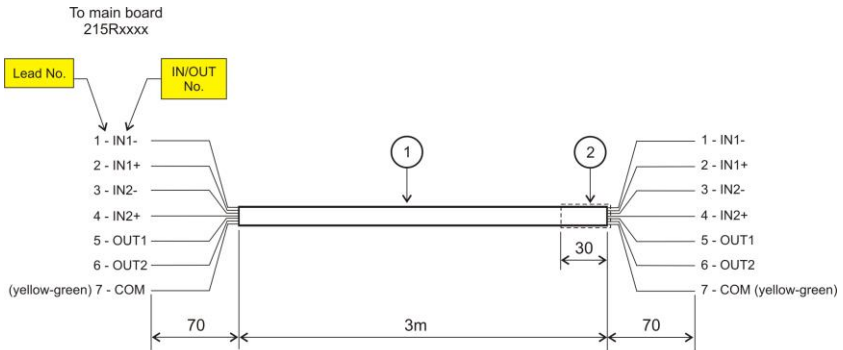

2	1	Insulation	RC 12.7/6.4
1	1	Cable	JZ-500 7G0.5mm2
Pos.	Pcs.	Component name	Designator

'Mass converter' – 'IN/OUT' cable (PT0146)

7. INSTALLATION

7.1. Unpacking and Installation



Mind not to damage cable connecting the mass converter and a weighing platform.

7.1.1. 1-Load-Cell Platform Scales of TWM1-x Series

- Take the scale out of the packaging.
- Place the scale on a flat and even surface. Keep it far away from any sources of heat.
- Remove transport locks and install the weighing pan:

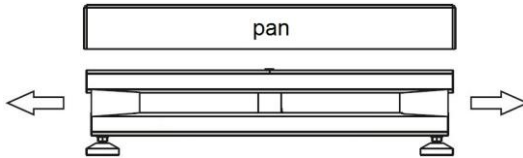

7.1.2. Platform Scales of TWM1-x.4.xx.C, TWM1-x.4.xx.H, TWM1-x.4.xx.H/Z Series

- Take the scale out of the packaging (pallet).
- Place the scale on a flat and even surface. Keep it far away from any sources of heat.
- Remove transport locks (if installed):

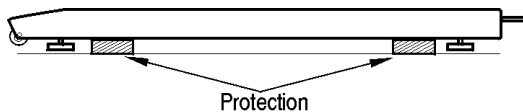

- Fix the feet (if not installed):

7.1.3. Ramp Scales of TWM1-x.4N Series

- Take the scale out of the packaging (pallet).
- Prior to installation, mount a steel bracket (2) onto a foot base (1), do it using an expanding ring (3), next screw the foot base (1) onto a foot pin (4).

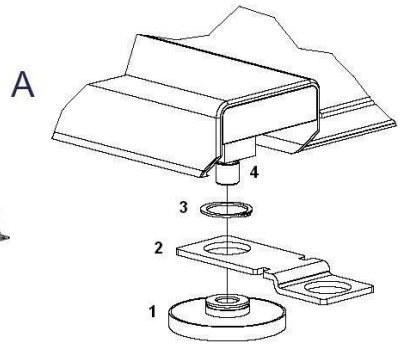
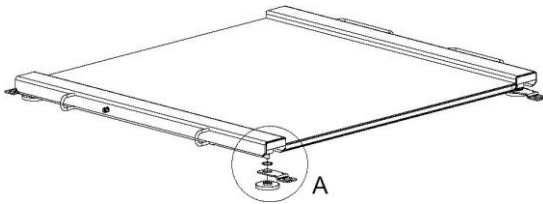

- Place the scale on an even surface, install ramps onto the steel brackets.
- Remove ramps, looking through bracket holes mark spots where openings for anchor bolts are to be made.
- Drill openings, mount steel brackets to the ground.

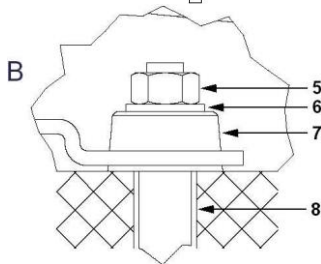
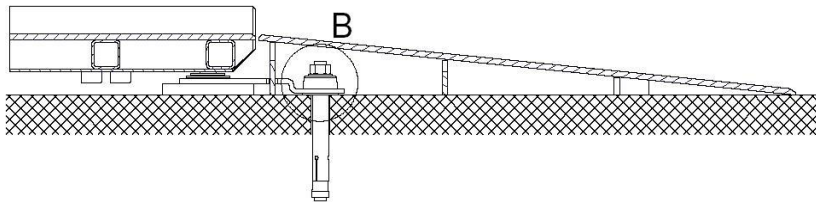

- 5 - nut
- 6 - washer
- 7 - centring cone
- 8 - anchor bolt

7.2. Levelling: 1-Load-Cell Platform Scales

It is necessary to level the scale, do it by turning its feet. Keep turning the feet until the air bubble takes central position:



level - OK



level incorrect

7.3. Levelling: 4-Load-Cell Platform Scales

To level the scale use the levelling feet and the level indicator. Each foot can be turned left and right, turning causes tilt. Adjustment span of the scale level is narrow therefore the correct level is obtained using steel washers which are to be put under the feet.

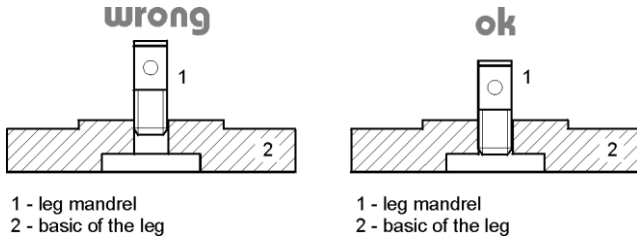

Keep turning the feet until the air bubble takes central position:

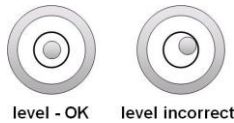

7.4. Start-Up

- Plug the power supply to the mains.
- Wait for connection to be established between the scale and the 'MwManager' software, read the weighing result.

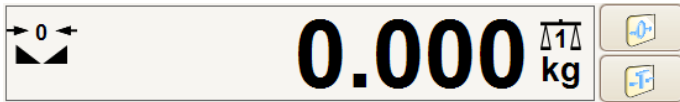

Symbols:

→ 0 ←	Zero indication.
▲▲	Stable weighing result.
Net	Tare function has been used.
kg	Weighing unit.
11	Weighing platform number.

Keys:

	Press to zero the scale
	Press to tare the scale

8. MwManager HOME SCREEN

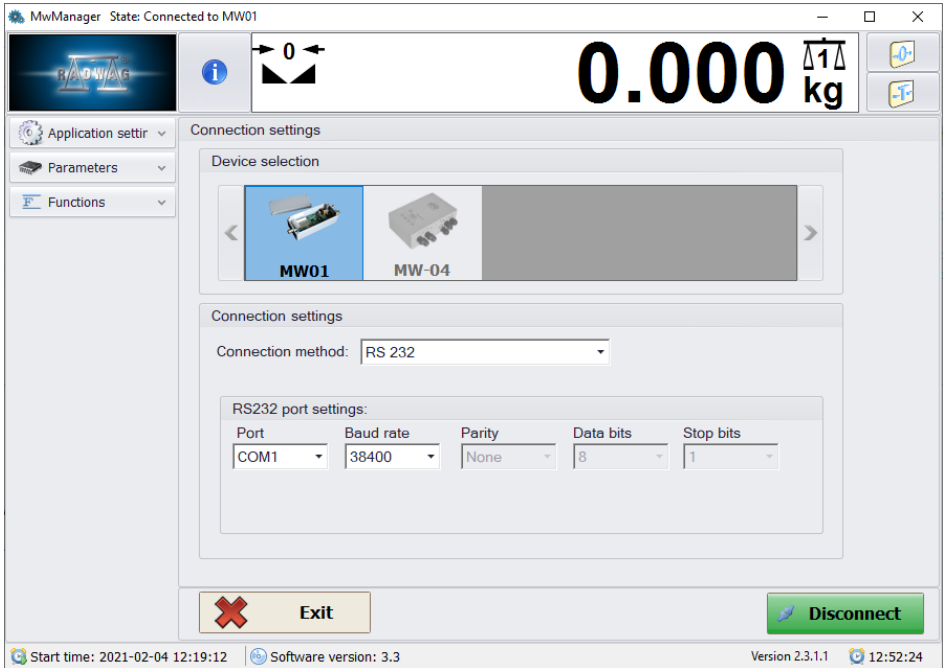







	<i>The procedure of communication establishing and a detailed description of connection between the scale and the 'MwManager' software is to be found in the 'MwManager' user manual.</i>
---	--

9. OPERATING THE MENU

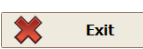
In order to operate the 'MwManager' software use a mouse and a PC keyboard. All temporary parameters that are not saved to the mass converter are marked red. To confirm the entered parameter values press **<ENTER>** key on the keyboard.

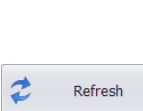
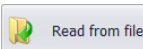
Buttons:

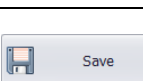
 <p>MW01</p>	MW-01 mass converter, TWM1 scale.
 <p>MW-04</p>	MW-04 mass converter, TWM4 scale.
 <p>Exit</p>	Exit button. Press to close the program. The following message is displayed: <Close program?> (where: <Yes> - press to stop the program; <No> - press to go to the program menu back).
 <p>Connect</p>	Connect button. Press to connect with the scale. Upon establishing connection, the button changes its function to „Disconnect” and the colour to green.
 <p>Disconnect</p>	Disconnect button. Press to disconnect with the scale. Upon disconnection, the button changes its function to „Connect” and the colour to red.
 <p>Refresh</p>	Refresh button. Parameter structure readout. In the case of no unsaved modifications, at the readout of parameter structure, the following message is displayed: <Readout successful> . In the case of some unsaved modifications, at the readout of parameter structure, the following information is displayed: <Unsaved modifications will be lost. Continue?> (where: <Yes> - press to read parameter structure wherein the unsaved modifications are lost; <No> - press to go to the program menu back).
 <p>Read from file</p>	Parameter import. For detailed information read the software user manual.
 <p>Save to file</p>	Parameter export. For detailed information read the software user manual.
 <p>Save</p>	Save button. Press to save parameter values. The following message is displayed: <Save parameters?> (where: <Yes> - record of the parameters confirmed with <Changes saved> message; <No> - press to go to the program menu back).

10. WEIGHING

Load the weighing pan. Read the result when  stability marker is displayed.

10.1. Good Weighing Practice: 1-Load-Cell Platform Scales

In order to guarantee a long-term operation, wherein correct measurements are provided, the following principles must be adhered to:

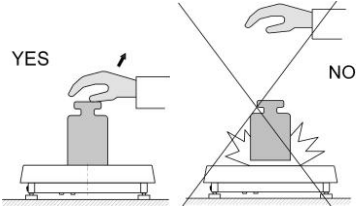
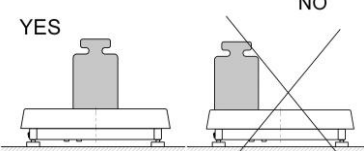
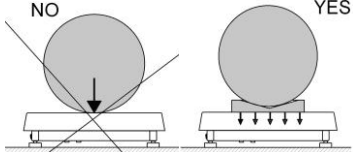
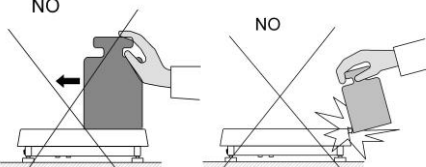
<p>Load the weighing pan steadily, avoid applying mechanical shocks.</p>	
<p>Place the loads centrally on the weighing pan (eccentricity errors are specified by EN 45501 standard, point 3.6.2).</p>	
<p>Do not apply concentrated force (total load in one point).</p>	
<p>Avoid side loading, in particular side shocks.</p>	

10.2. Good Weighing Practice: Custom Scales

It is forbidden to apply load other than intended for a particular scale:

- beam scales; self-supporting, rigid load or load placed in rigid load-transferring packaging:

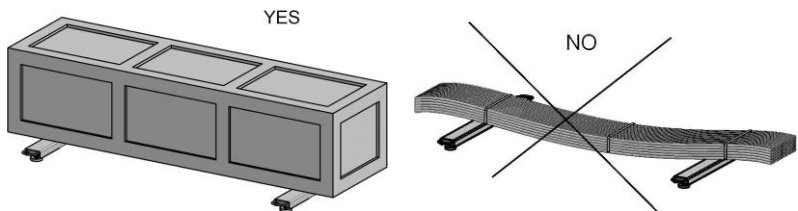

- pallet scales (load placed on EUR-pallet loaded using pallet truck); middle block of pallet placed on the scale must remain unsupported:

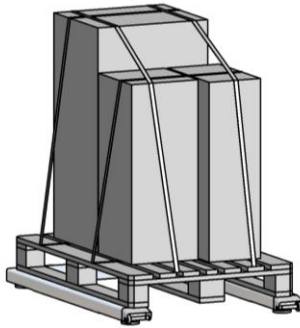

- ramp scales (trucks used in meat plants); it is necessary to select platform matching the span of truck casters, this is to make sure that in the case of trucks of weight close to the maximum capacity, the load is transferred onto the platform close to load-carrying sections (profiles):

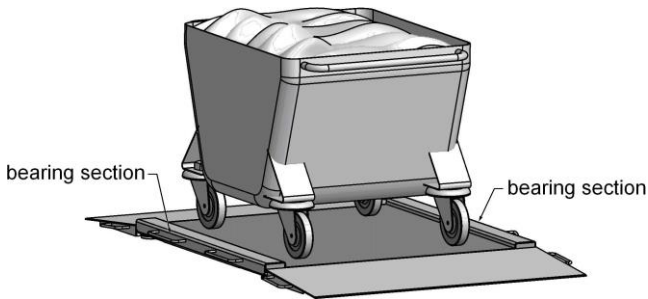

10.3. Zeroing



To zero mass indication press  key. Zero indication and the following pictograms are displayed: $\rightarrow 0 \leftarrow$ and .

Zeroing operation means determining new zero point, recognized by the weighing device as precise zero. The instrument can be zeroed only when the indication is stable.



Indication can be zeroed only within $\pm 2\%$ range of the maximum capacity. If the zeroed value is greater than $\pm 2\%$ of the maximum capacity, then the software displays a respective error message: <Err2>.

10.4. Taring

To determine net weight value, load the weighing pan with a packaging, wait for a stable indication and press  key. Zero indication and the following pictograms are displayed: **Net** and . The scale has been tared.

Remember not to exceed the maximum capacity, i.e. sum of tare weight value and load weight value must be lower than the maximum capacity value. Upon unloading of the weighing pan, the sum of tared masses with minus sign is displayed.

	<i>It is impossible to tare zero or negative values. When you tare zero or negative values the scale responds with the following message: <Err3>.</i>
---	--

10.5. Dual Range Devices

N/A in case of single range scales

Switching from weighing with the accuracy of the **1 weighing range** to weighing with the accuracy of the **2 weighing range** takes place automatically upon exceeding Max of the **1 weighing range**.

In case of dual range scales:

- upon switching to weighing with the accuracy of the 1 weighing range, **→1←** pictogram/marker is displayed on the left,
- upon switching to weighing with the accuracy of the 2 weighing range, **→2←** pictogram/marker is displayed on the left.

Switching from weighing with the accuracy of the **II weighing range** to weighing with the accuracy of the **I weighing range** takes place automatically upon unloading of the weighing pan and returning to AUTOZERO – (**→0←** pictogram/marker is displayed).

11. TECHNICAL SPECIFICATIONS

For technical specifications of respective scales go to RADWAG website www.radwag.pl.

12. ERROR MESSAGES

Err2	Value out of zero range.
Err3	Value out of tare range.
Err4	Calibration mass or start mass beyond the acceptable range ($\pm 1\%$ for weight, ± 10 for start mass).
Err8	Taring/zeroing time out of range.
NULL	Zero value from converter.
FULL	Weighing range exceeded.
HI	Display capacity out of range.
LH	Start mass error, indication out of range ($-5\% - +15\%$ of start mass).



RADWAG BALANCES AND SCALES
ADVANCED WEIGHING TECHNOLOGIES

