

# Susceptometer

SM-UYA 5Y  
SM-MYA 5Y

## USER MANUAL

IMMU-99-02-09-23-ENG



[www.radwag.com](http://www.radwag.com)

Congratulations and thank you for selecting RADWAG product.  
You have purchased a device that has been designed and manufactured to give you years of service.  
Please read this User Manual carefully, this shall guarantee reliable operation.

SEPTEMBER 2023

## CONTENTS

<b>1. GENERAL INFORMATION</b>	<b>7</b>
1.1. Dimensions	7
1.2. Connectors Arrangement	8
1.3. Intended Use	8
1.4. Precautions	8
1.5. Warranty Conditions	9
1.6. Supervision Over Metrological Parameters	9
1.7. User Manual Significance	9
1.8. Operator Training	9
<b>2. TRANSPORT AND STORAGE</b>	<b>10</b>
2.1. Delivery Check	10
2.2. Packaging	10
<b>3. UNPACKING AND INSTALLATION</b>	<b>10</b>
3.1. Place of Use	10
3.2. Unpacking	11
3.3. Standard Delivery Components List	12
3.4. Workroom and Basic Operation Guidelines	12
3.5. Connecting the Device to the Mains	14
3.6. Temperature Stabilization Time	14
3.7. Connecting Peripheral Equipment	14
<b>4. MAINTENANCE</b>	<b>14</b>
<b>5. START-UP</b>	<b>17</b>
<b>6. PROGRAM</b>	<b>18</b>
<b>7. HOME SCREEN</b>	<b>19</b>
<b>8. LOG IN OPERATION</b>	<b>20</b>
<b>9. OPERATING THE MENU</b>	<b>21</b>
9.1. Operation Panel	21
9.2. Voice Commands	21
9.3. Return to Weighing	23
<b>10. ADJUSTMENT</b>	<b>23</b>
10.1. Internal Adjustment	23
10.2. External Adjustment	23
10.3. Adjustment Test	24
10.4. Automatic Adjustment	24
10.5. Automatic Adjustment Time	24
10.6. Report Printout	24
10.7. GLP Project	24
10.8. Adjustment History	25
<b>11. ADMINISTRATOR PANEL</b>	<b>26</b>
11.1. Password Settings	26
11.2. Operator Accounts Settings	26
11.3. Permissions Management	27

11.4. Remote access password.....	28
<b>12. PROFILES.....</b>	<b>29</b>
12.1. Creating a Profile .....	29
12.2. Profile Structure .....	30
12.2.1. Settings .....	31
12.2.2. Working Modes .....	31
12.2.3. Readout .....	31
12.2.4. Units.....	33
<b>13. WORKING MODES - GENERAL INFORMATION .....</b>	<b>34</b>
13.1. Working Modes .....	34
13.2. Working Mode Parameters.....	34
13.3. Quick Access Buttons, Proximity Sensors.....	35
13.3.1. Proximity Sensors .....	36
13.4. Information .....	37
13.5. Printouts .....	37
13.6. PROFILES.....	39
<b>14. WEIGHING .....</b>	<b>40</b>
14.1. Weighing Unit Selection .....	40
14.2. Good Weighing Practice.....	40
14.3. Level Status .....	41
14.4. Zeroing .....	41
14.5. Taring.....	41
14.6. Use of Air Buoyancy Compensation Factor .....	42
14.7. Additional Parameters for a Weighing Process .....	44
14.8. Ambient Conditions - Vibrations .....	46
<b>15. MAGNETISM .....</b>	<b>50</b>
15.1. Printouts .....	53
15.2. Performed Mass Control Report.....	54
<b>16. DATABASES.....</b>	<b>55</b>
16.1. Database Operations .....	55
16.2. Operators.....	56
16.3. Products.....	61
16.4. Customers.....	63
16.5. Packaging.....	63
16.6. Warehouses.....	63
16.7. Printouts .....	64
16.8. Universal Variables .....	66
16.9. Databases Management .....	66
16.9.1. Delete Databases .....	66
<b>17. REPORTS.....</b>	<b>67</b>
17.1. Reports Operations.....	67
17.2. Weighings .....	68
17.3. Susceptibility: Reports .....	69
17.4. Ambient Conditions .....	69
17.5. Reports Management.....	69
17.5.1. Export Weighing Database to a File .....	70
17.5.2. Delete Weighings and Reports.....	71



<b>18. COMMUNICATION .....</b>	<b>73</b>
18.1. RS232 Ports Settings .....	73
18.2. ETHERNET Port Settings .....	74
18.3. Wi-Fi Settings .....	74
18.3.1. Hot Spot - General Information .....	75
18.3.2. Hot Spot Activation.....	75
18.4. TCP Settings.....	77
18.5. Virtual COM Settings.....	78
<b>19. PERIPHERALS .....</b>	<b>78</b>
19.1. Computer.....	78
19.1.1. Computer address .....	79
19.1.2. Permanent transmission .....	79
19.1.3. Interval.....	80
19.1.4. Weighing printout template .....	80
19.1.5. Cooperation with E2R System .....	80
19.2. Printer .....	81
19.3. Barcode Scanner .....	83
19.3.1. Barcode Scanner Port .....	83
19.3.2. Prefix/Suffix.....	84
19.3.3. Field Selection .....	84
19.3.4. Test.....	85
19.4. Ambient Conditions Module .....	85
19.5. IM02 communication module .....	86
19.5.1. Activation of IM02-to-scale connection .....	86
19.6. Automatic Feeder .....	86
<b>20. INPUTS/OUTPUTS.....</b>	<b>87</b>
20.1. Input Setup .....	87
20.2. Output Setup .....	87
<b>21. MISCELLANEOUS PARAMETERS.....</b>	<b>88</b>
21.1. Interface Language.....	88
21.2. Date and Time .....	88
21.3. Extension Module .....	89
21.4. Sound.....	90
21.5. Visual printout cofirmation.....	90
21.6. Sleep Mode.....	90
21.7. Display Brightness.....	90
21.8. Vibration Detection .....	91
21.9. Level Control .....	91
21.10. Decimal Point .....	91
21.11. Proximity Sensors Sensitivity.....	92
21.12. Doorway Degree .....	92
21.13. Automatic Ionization.....	92
21.14. Autotest.....	92
21.15. Start-Up Logo .....	96
21.16. Export of System Events .....	96
21.17. Text-to-speech conversion .....	96
<b>22. SCHEDULED TASKS .....</b>	<b>96</b>
22.1. Adjustment.....	96
22.1. Message.....	98

<b>23. UPDATE.....</b>	<b>99</b>
<b>24. ABOUT .....</b>	<b>100</b>
<b>25. COMMUNICATION PROTOCOL .....</b>	<b>100</b>
25.1. Manual Printout / Automatic Printout .....	100
<b>26. CONNECTING PERIPHERALS .....</b>	<b>101</b>
<b>27. ERROR MESSAGES.....</b>	<b>102</b>
<b>28. ADDITIONAL EQUIPMENT .....</b>	<b>102</b>
<b>29. ANNEX B – Programmable Buttons List.....</b>	<b>103</b>

# 1. GENERAL INFORMATION

## 1.1. Dimensions

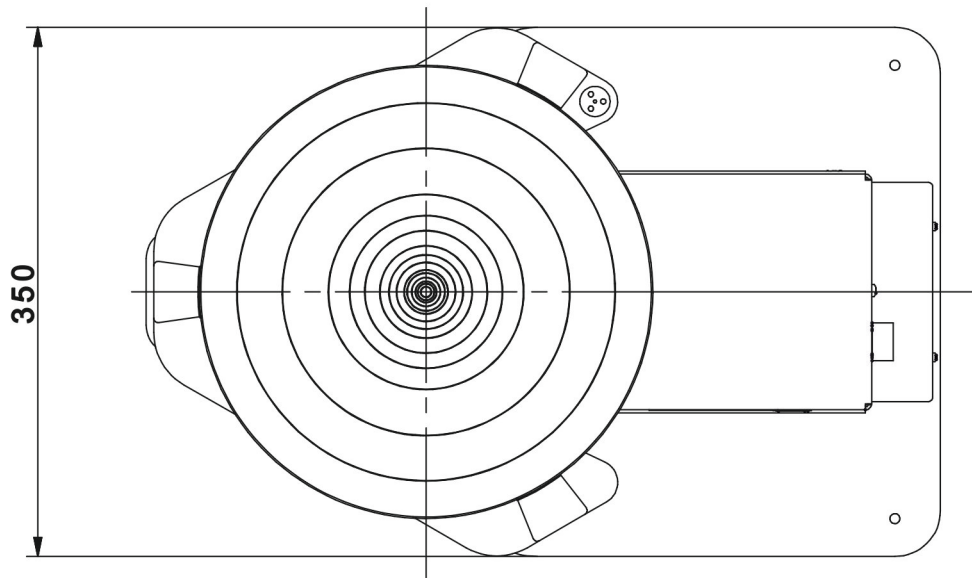
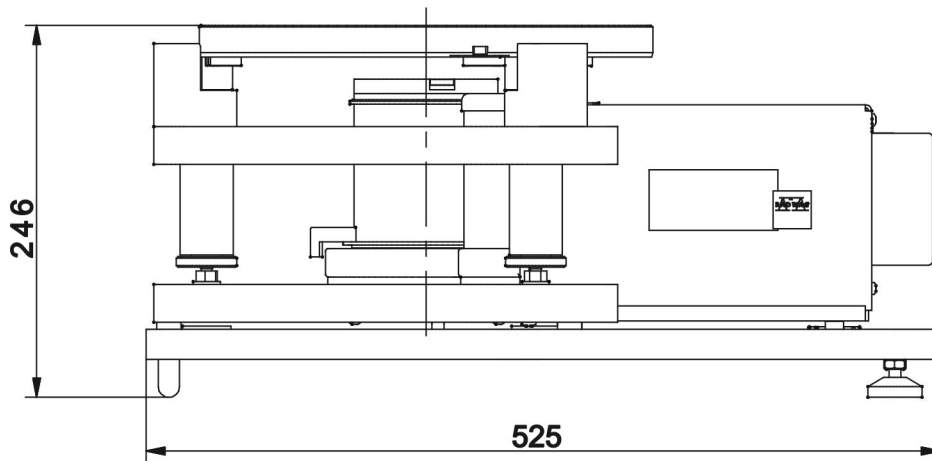

Indicator

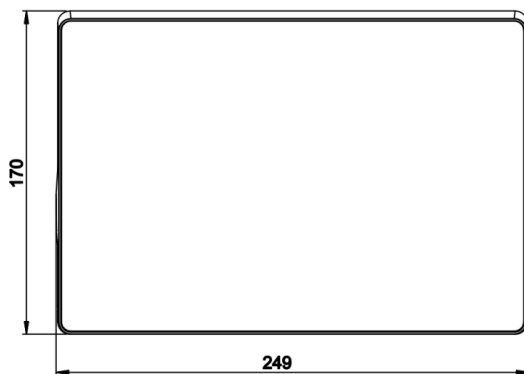
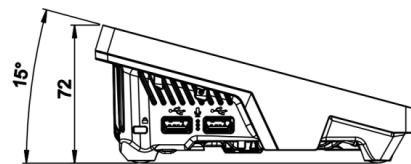
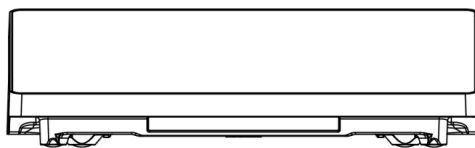

## 1.2. Connectors Arrangement

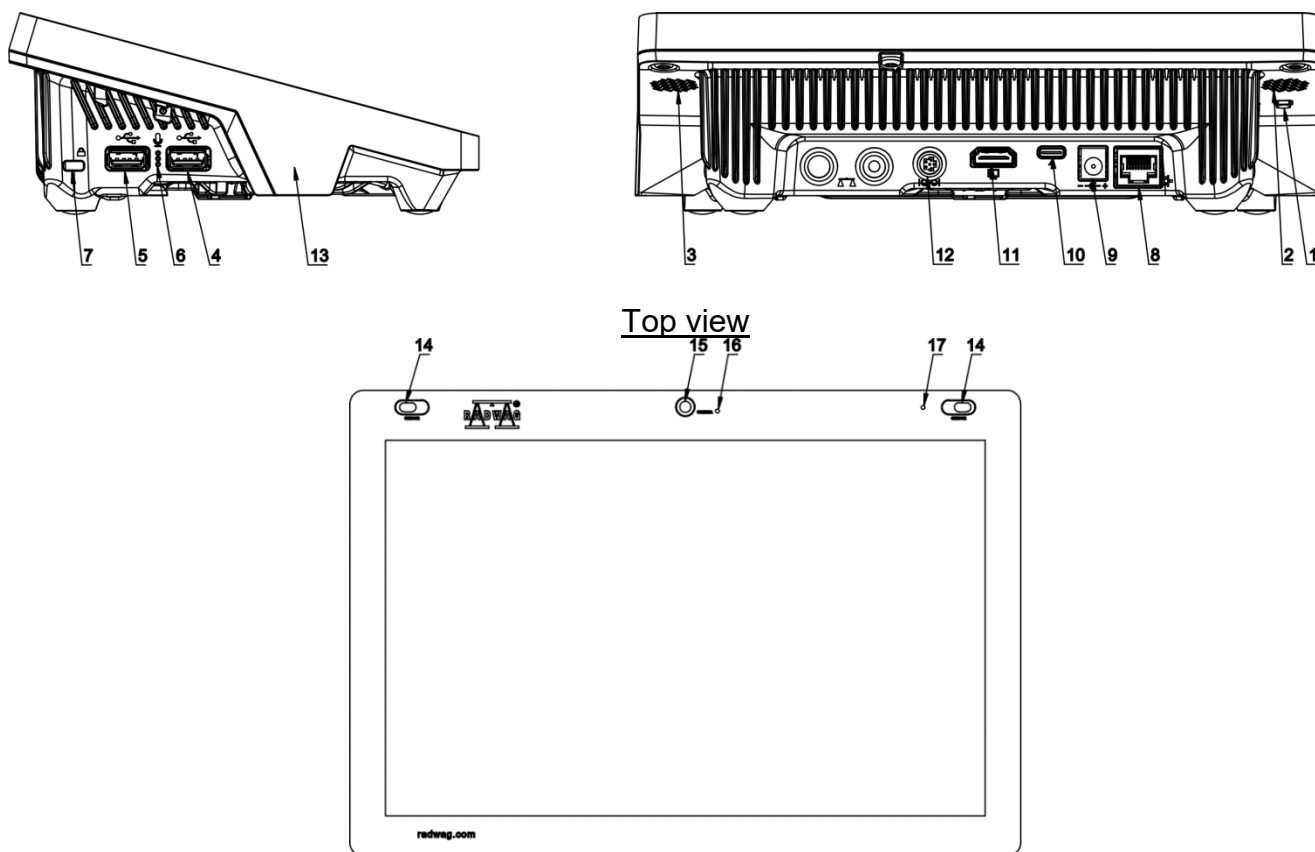

<b>1</b>	Button used to hard restart or to switch the balance off/on.	<b>10</b>	Power supply socket – USB type C
<b>2</b>	Left speaker	<b>11</b>	HDMI socket
<b>3</b>	Right speaker	<b>12</b>	Media box socket
<b>4</b>	USB type A	<b>13</b>	RFID sensor
<b>5</b>	USB type A	<b>14</b>	Proximity sensors
<b>6</b>	Microphone	<b>15</b>	Camera
<b>7</b>	Kensington Lock	<b>16</b>	Camera diode
<b>8</b>	Ethernet socket	<b>17</b>	Signalling diode
<b>9</b>	Power supply socket		

## 1.3. Intended Use

SM susceptometer enables carrying out measurements of magnetic susceptibility and magnetization of mass standards and weights of class E1 and lower in accordance with OIML R111. The susceptometer is intended for accurate measurements in laboratory conditions.

## 1.4. Precautions

- Prior the first use, carefully read this User Manual. Use the device only as intended.
- Do not operate the touch panel using sharp-edged tools (knife, screwdriver, etc.).
- Place weighed loads in the centre of the weighing pan.
- Load the weighing pan with loads of gross weight which does not exceed the maximum capacity.
- Mind not to leave heavy loads on the weighing pan for longer periods of time.
- In case of damage, immediately unplug the device from the mains.

- Scales to be decommissioned must be decommissioned in accordance with valid legal regulations.
- Do not use the weighing instrument in areas endangered with explosion. The balance is not intended to be operated in hazardous areas.

### **1.5. Warranty Conditions**

- A. RADWAG feels obliged to repair or exchange all elements that appear to be faulty by production or by construction.
- B. Defining defects of unclear origin and means of their elimination can only be realized with assistance of the manufacturer and user representatives.
- C. RADWAG does not bear any responsibility for damage or loss resulting from unauthorized or inadequate performing of production or service processes.
- D. The warranty does not cover:
  - mechanical damage caused by product exploitation other than intended, damage of thermal and chemical origin, damage caused by lightning, overvoltage in the power network or other random event,
  - damage caused by product exploitation other than intended,
  - mechanical damage, if service claims removing or destroying protective stickers which secure the device's housing against unauthorized access,
  - damage caused by liquids, water and natural wear,
  - damage caused by inappropriate setting or by electrical wiring failures,
  - damage caused by overloading of the mechanical measuring system,
  - inappropriate cleaning habits.
- E. Loss of warranty takes place if:
  - a repair is carried out outside RADWAG authorized service point,
  - service claims intrusion into mechanical or electronic construction by unauthorized people,
  - other than original version of the operating system is installed in a balance,
  - the device does not bear security seal stickers.
- F. For detailed warranty conditions read the warranty certificate.

### **1.6. Supervision Over Metrological Parameters**

Metrological parameters need to be checked in determined time intervals. Inspection frequency depends on ambient conditions in which the weighing instrument is operated, kind of carried out processes and adopted quality management system.

### **1.7. User Manual Significance**

Even if you are experienced and have already worked with this type of weighing instrument, you are still obliged to read this user manual carefully prior switching the device on. This user manual contains crucial information for correct operation of the module. As long as you follow the guidelines your balance operation is correct and reliable.

### **1.8. Operator Training**

The weighing device must be utilized and supervised only by personnel who have been trained to use such type of a weighing device.

## **2. TRANSPORT AND STORAGE**

### **2.1. Delivery Check**

Upon delivery it is necessary to check the package and the device, make sure that your package bears no signs of damage. Otherwise contact the manufacturer's representative.

### **2.2. Packaging**

Keep all package elements should your device be transported in the future. Remember that only original packaging can be used for shipping purposes. Prior packing, uncouple any cables, remove any separable components (weighing pan, shields, inserts). The device components shall be packed into an original packaging, thus being protected against potential damage during transportation.

## **3. UNPACKING AND INSTALLATION**

### **3.1. Place of Use**

- Operate the device in a workroom free of vibrations and shakes, where there are no air drafts nor dust.
- Make sure that the ambient temperature ranges between: +10 °C ÷ +40 °C,
- Make sure that the relative humidity is not higher than 80%,
- Make sure that the temperature changes slowly in the course of operation.
- Place the weighing instrument either on a robust-design table or on a wall bracket, which is both distant from heat sources and unsusceptible to vibrations.

### 3.2. Unpacking

Cut the adhesive tape. Take the device components and the wooden box with the device out of the packaging. Unscrew 3 screws fixing the device to the box and take them out. Screw 2 feet and base bracket into device's base.

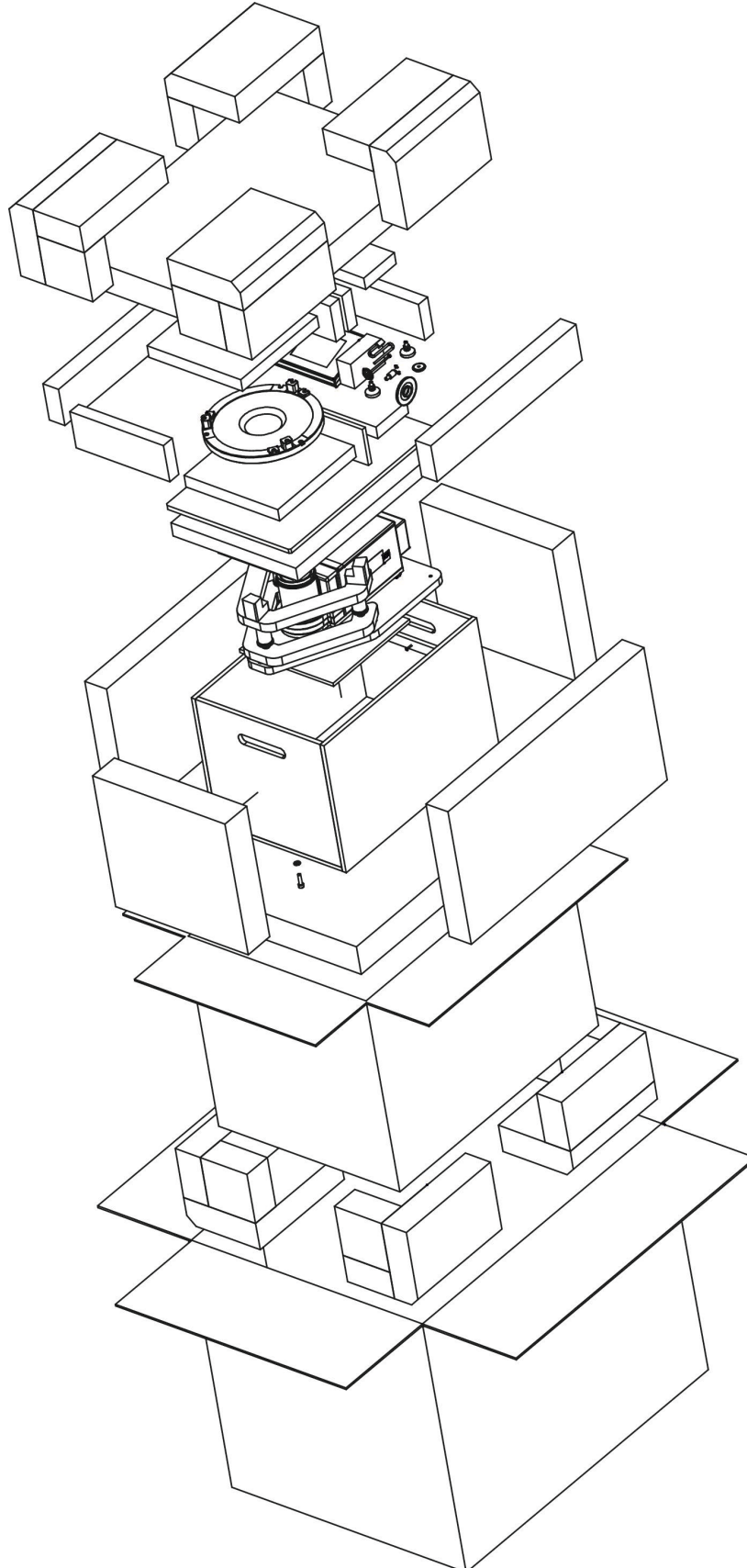

### **3.3. Standard Delivery Components List**

- Balance
- Device feet
- Base support
- Mass standard support
- Mass standard support plate
- Draft shield
- Magnet
- Magnet support
- Weighing pan
- Anti-draft chamber glass lid
- Power supply

### **3.4. Workroom and Basic Operation Guidelines**

Put the weighing instrument in the place of use, on stable base, and install the weighing pan. Follow the below procedure.

Steps:

1. Place the balance (1) at its workstation.
2. Install the draft shield (2).
3. Install the magnet support (4).
4. Place the magnet (5) in the support's socket.
5. Install the anti-draft chamber glass lid (6).
6. Install the mass standard support (7) on the devices base by assembling bracket pin into corresponding base sockets.
7. Install the mass standard support plate (8) by assembling support's pins into corresponding plate sockets depending on tested mass standard (see description in section 15).

If the device is to be used to weight mass standards and other samples, dismantle mass standard support plate (8), mass standard support (7), magnet (5) and magnet support (4). Next, install weighing pan (3) in the weighing chamber in the place where magnet support was previously installed.

Such prepared susceptometer can work as a balance.



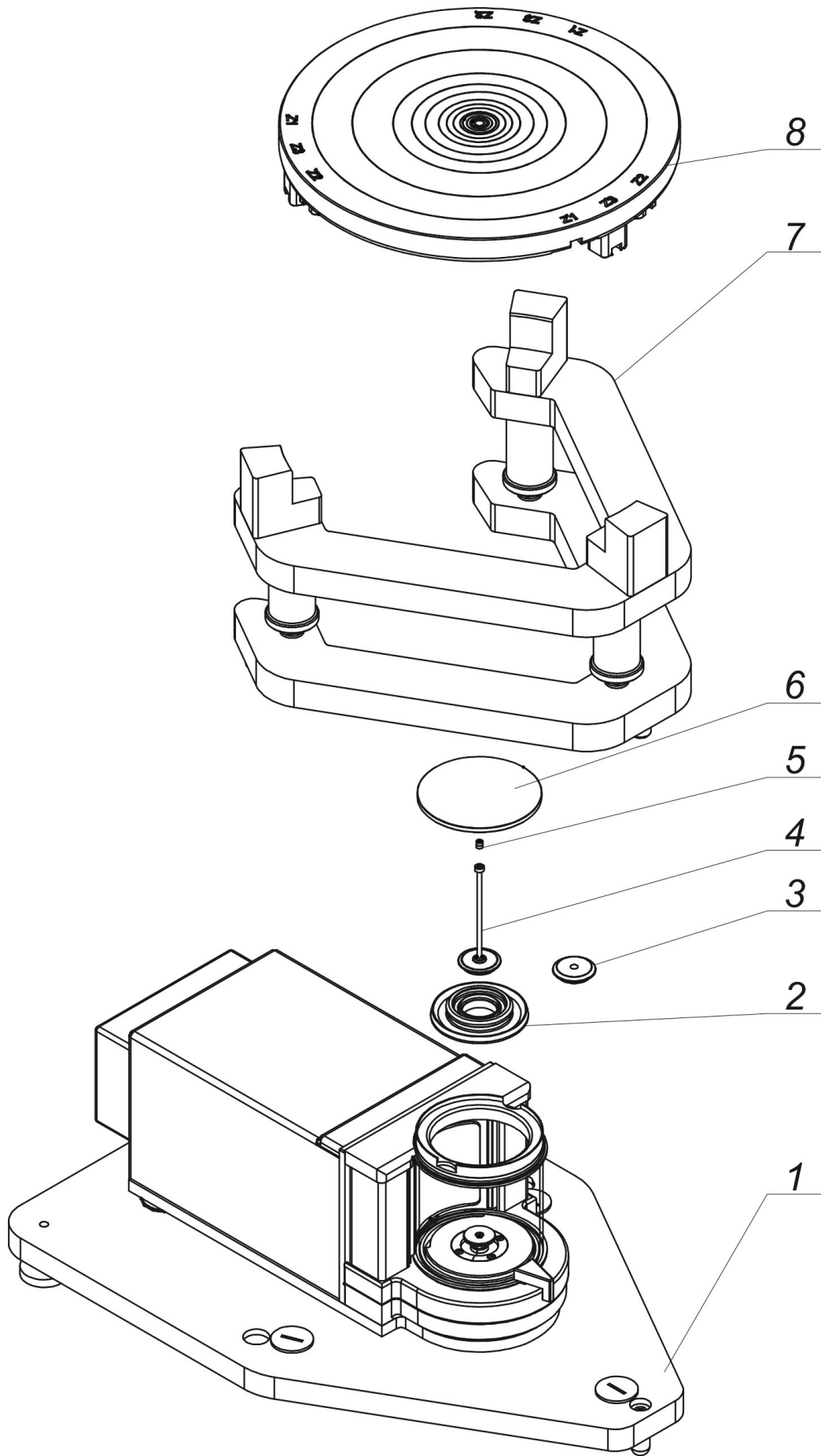

### 3.5. Connecting the Device to the Mains

The weighing device can be connected to the mains only with a power supply that comes standard with a particular model. Nominal voltage of the power supply (specified on the power supply data plate) has to be compatible with the mains nominal voltage.

Plug the balance to the mains – connect the power adapter to the socket, next connect its connector to interface located at the back of the balance housing.

### 3.6. Temperature Stabilization Time

Prior to measuring processes start, it is necessary to wait until the platform reaches thermal stabilisation.

Balances stored in much lower temperatures, than the workroom temperature, before being plugged to the mains (e.g. during winter period) must be subjected to thermal stabilisation. The thermal stabilisation period takes about 12 hours. During the thermal stabilization, the indications on the screen may change. Potential workroom temperature change shall occur gradually and slowly in the course of the weighing instrument operation.

### 3.7. Connecting Peripheral Equipment

Use only accessories and peripheral equipment recommended by the manufacturer. The balance must be disconnected from the mains before connecting or disconnecting any peripherals (printer, PC computer, computer keyboard of USB type, additional display). Upon connecting the peripherals, plug the module to the mains.

## 4. MAINTENANCE

### **CAUTION:**

*Cleaning the weighing pan while still installed may cause damage of the measuring system.*

1. Uninstall the weighing pan and other detachable components (the components differ depending on a balance type – see section: *UNPACKING AND INSTALLATION*). Be careful while installing the components so as not to cause any damage to the balance mechanism. Remove the weighing pan of a microbalance using tweezers.
2. Using handheld vacuum cleaner remove dust from the weighing chamber (recommended for the microbalance).
3. In order to ease cleaning of some of the weighing instrument components, it is permissible to remove them following the below instruction.

### Cleaning anti-draft chamber panes:

*Select dissolvent depending on the type of contamination. Never soak the glass panes in alkaline solutions since they interact with glass and may cause damage. Do not use cleansers containing abrasive substances.*

*For organic dirt use acetone first, next use water or detergent. For other than organic dirt use diluted acid solutions (soluble salts of hydrochloric or nitric acid) or base solutions (ammonium or sodium base).*

*To remove ACIDS use protophilic solvent (sodium carbonate), to remove BASE use protogenic solvent (mineral acid of various concentration).*

*In case of heavy contamination, use brush and detergent, nevertheless avoid detergents containing large and hard molecules which could potentially scratch glass panes.*

*At the end of the cleaning process rinse the pane using distilled water.*

*Use soft brush with wooden or plastic handle exclusively to avoid risk of scratches. Do not use wire brush.*

*Rinsing is a necessary cleaning process stage allowing to remove remaining soap, detergents and other cleansers from the panes prior to their reinstallation.*

*After the preliminary cleaning process stage, rinse the pane using running water first, distilled next.*

*Avoid drying the panes either using paper towel or forced air circulation since some fibres, grains or contamination of other type could permeate into the panes thus causing weighing errors.*

*We do not recommend using driers when drying measuring glass tools.*

*It is a frequent treatment to leave glass components on a rack to dry.*

#### *Cleaning powder-coated components:*

*For preliminary cleaning process stage you need running water or wet sponge with large pores, this will help you to remove loose, heavy dirt.*

*Do not use cleansers containing abrasive substances.*

*Next, using cloth and cleanser-water solution (soap, dishwashing liquid) gently rub the surface.*

*Avoid using cleanser without water since it may result in damage of the cleaned surface, please mind that large amount of water mixed with cleanser is a must.*

#### *Cleaning aluminium components:*

*While cleaning aluminium components use products acid by nature, e.g. spirit vinegar, lemon. Do not use cleansers containing abrasive substances. Avoid using hard brush, this may cause scratches. It is recommended to use microfibre cloth.*

*While polishing the surface use circular movements. Use clean, dry cloth to make the surface shine.*

### Cleaning stainless steel components

When cleaning stainless steel components, the following table should be followed, which lists the types of contamination and ways of removing it.

Fingerprints	Clean with alcohol or dilutant. Rinse with clean water and wipe dry.
Oils, fats, greases	Wash with organic solvents and then clean with warm water with soap or mild detergent. Rinse with clean water and wipe dry.
Temperature stains and discolorations	Wash with a gentle abrasive cleaner, clean lightly according to the direction of the surface structure. Rinse with clean water and wipe dry.
Strong discoloration	Clean lightly according to the direction of the surface structure. Rinse with clean water and wipe dry.
Traces of rust	Moisten with oxalic acid solution and leave for about 15-20 minutes, then wash with warm water with soap or mild detergent. Rinse with clean water and wipe dry.
Paints	Wash with paint solvent and then rinse with warm water with soap or mild detergent. Rinse with clean water and wipe dry.
Scratches on the surface	Gently polish the surface with a non-woven fabric (iron-free) according to the direction of the surface structure. Wash with a gentle abrasive cleaner. Rinse with clean water and wipe dry.

### Cleaning ABS components

*To clean dry surfaces and avoid smudging, use clean non-colouring cloths made of cellulose or cotton. You can use a solution of water and detergent (soap, dishwashing detergent, glass cleaner). Gently rub the cleaned surface and let it dry. Repeat the cleaning process if necessary.*

*In the case of hard to remove contamination, e.g. residues of adhesive, rubber, resin, polyurethane foam etc., you can use a special cleaning agents based on a mixture of aliphatic hydrocarbons that do not dissolve plastics. Before using the cleanser for all surfaces, we recommend carrying out tests. Do not use cleansers containing abrasive substances.*

## 5. START-UP

- Power the balance.

*CAUTION: There are two sockets on the balance for connecting to the power supply. The indicator has one socket, and the weighing mechanism housing has the other. The balance can be powered from both the indicator and the weighing mechanism, but not simultaneously from both sides, using two power supplies. Such a connection may result in damage to the balance and power supplies.*

- After a while, the procedure of loading the operating system with RADWAG software gets started. During start-up, the signalling diodes and LEDs at the front of the indicator start blinking.
- Upon balance start-up, the home screen is displayed.
- Upon completed start-up of the remaining balance series, the home screen is displayed automatically.
- The balance runs with no user logged in. In order to start operation, it is necessary to log in (for detailed login procedure, read later sections of this user manual).



**Caution:** *Prior to the balance start, make sure that there is no load on the weighing pan.*

*If the software crashes during operation, carry out a hard reset. To do this, press and hold for about 5s the button on the indicator. The software will reset and restart.*

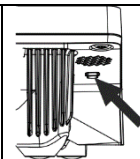

## 6. PROGRAM

Program menu is divided into function groups. A function group is a group of interrelated parameters. For detailed description of each group, read later sections of this service manual.

### Function groups:



The main menu is accessed by pressing  button located in the bottom part of the display.

The menu comprises parameters related to balance settings, functions and profiles.

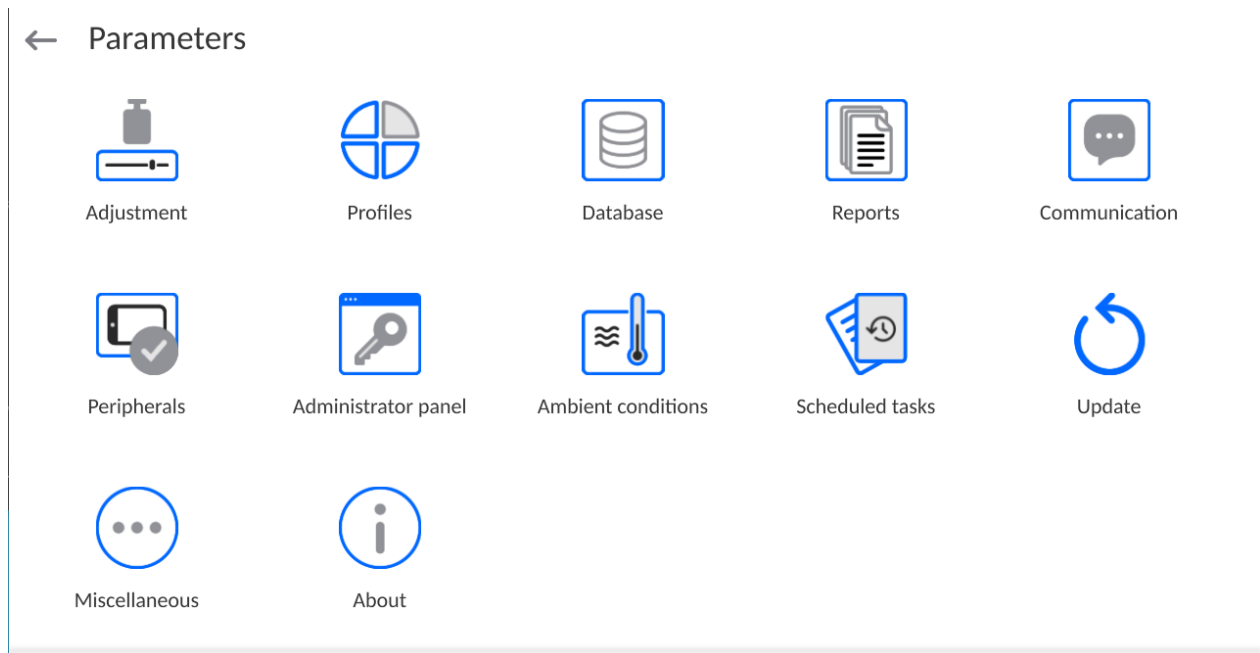

## 7. HOME SCREEN



### The home screen features 5 sections:

- Top section displaying data on active working mode, logged-in user, date, time, computer connection status.

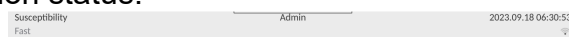

- Section presenting the weighing result and a current level status.

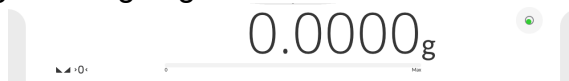

- Section comprising supplementary information on currently performed operations (grey background).



### **CAUTION:**

*Data contained in this workspace is freely configurable. For detailed information, read section 13.4 of this user manual.*

- Section comprising on-screen function buttons:

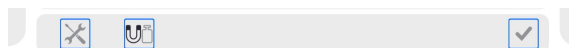

### **CAUTION:**

*The operator can define the on-screen function buttons. For detailed information, read section 13.3 of this user manual.*

- Section comprising on-screen function buttons:



## 8. LOG IN OPERATION

In order to access operator-related parameters and edit databases, you need to log in as an operator with **<Administrator>** permission level.

To do this, pull down the menu at the top of the display.

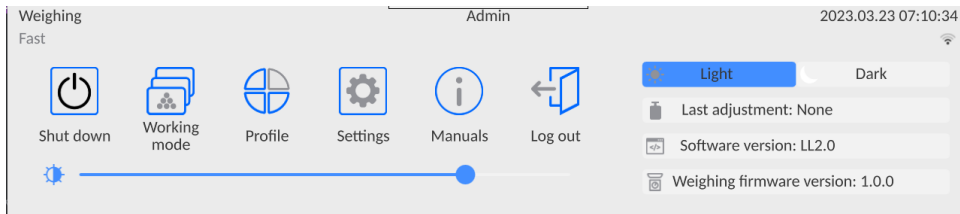

### First Log in:

- Pull down the top menu, press **<Log in>** field, operators database window is opened featuring **<Admin>** entry.

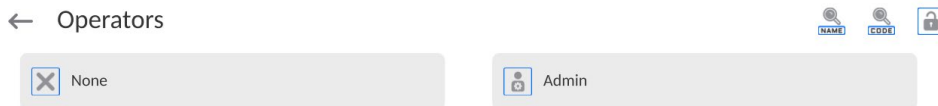

- The home screen is displayed, **<Not logged in>** sign is replaced by **<Admin>** sign.

**CAUTION: After first logging in, enter operators and assign appropriate permission levels and individual access passwords to them (for detailed procedure, read sections 11 and 16.2). While logging in again, select an operator from the list and enter the password, the program initiates operation with permission level set for the selected operator.**

### Log out operation:











- Pull down the menu at the top of the display.
- Press **<Log out>** field.
- The home screen is displayed, logged in operator name is replaced with **<Not logged in>** entry.



## 9. OPERATING THE MENU

Operation of the program menu is intuitive. The touch panel makes the software operation easy. Pressing a function button or an area on the display initiates an assigned function or a process.

### 9.1. Operation Panel

	Press to enter the main menu.
	Press to confirm modification.
	Press to return to the previous view without changing the parameter value.
	Press to add a database record.
	Press to search for a particular database entry by date.
	Press to search for a particular database entry by name.
	Press to search for a particular database entry by code.
	Press to print database entries.
	Press to select printout template variables from the list.
	Press to go back.

### 9.2. Voice Commands

The balance software allows several operations to be performed using voice commands. These are: tare, zero, print/save measurement. The commands must be spoken in English, in the correct sequence. Below is the structure of the individual commands.

Tare: **ellipsis [please] (tare | tar | terre) [the] device**

Zero: **ellipsis [please] zero [the] device**

Print/Save: **ellipsis [please] save [the] (mass | measurement | mass measurement)**

How to say the command: black text is mandatory, green - may or may not be spoken, red - one of the texts is mandatory to be spoken

e.g: for Print command: **ellipsis save mass.**

**Procedure:**

3. Place the  button for activating voice commands on the button bar (for how to add buttons, read further down this manual).

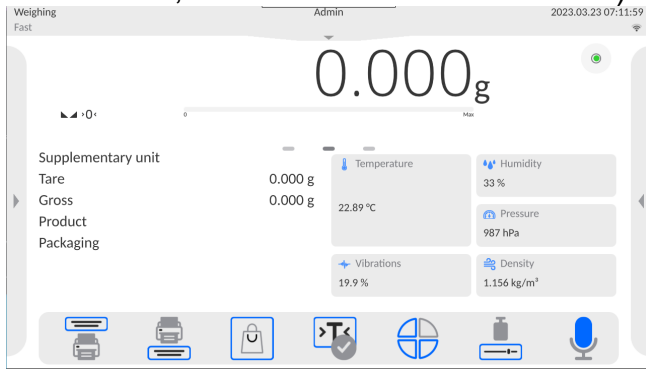

4. Press .
5. The voice command recognition procedure is initiated and the user is informed about it through the displayed messages.

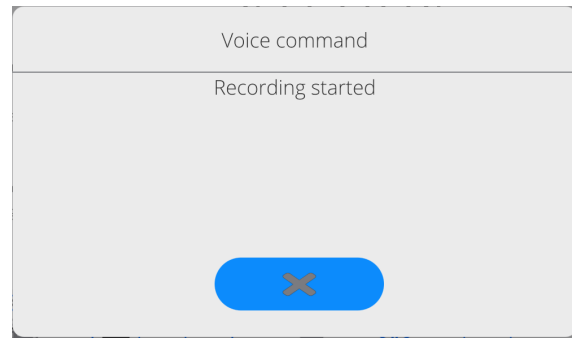
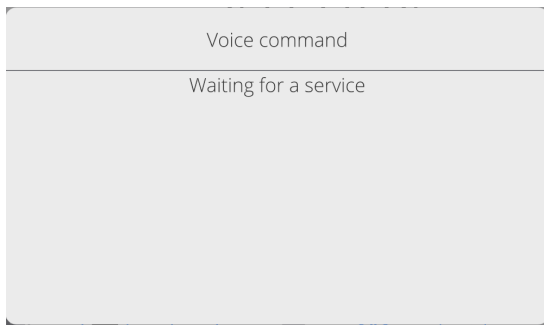

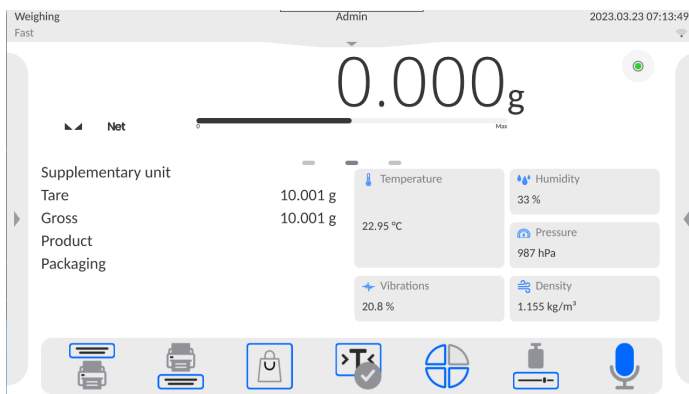
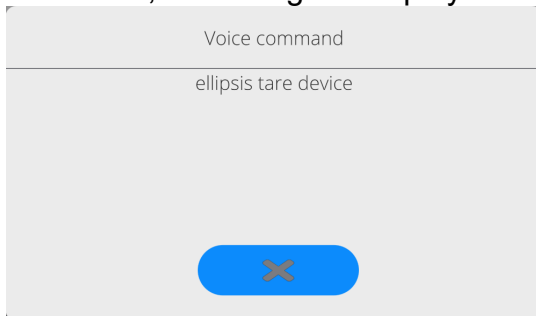

6. Say the command as described above.
7. If the command is spoken correctly and the balance program recognizes the command, a message is displayed and the command is automatically executed.



### 9.3. Return to Weighing

Modifications introduced into balance memory are automatically saved upon return to weighing operation.

#### Procedure:

- Press  button repeatedly, keep pressing it until you see the home screen.
- Press  button (top bar), the home screen is displayed immediately.

## 10. ADJUSTMENT

The module features automatic internal adjustment system which ensures correct measurement accuracy. <ADJUSTMENT> menu contains functions controlling operation of module adjustment process.

### 10.1. Internal Adjustment

Internal adjustment is carried out by means of an internal adjustment weight. <Internal adjustment> button, when pressed, automatically triggers adjustment process. Upon adjustment process completion, a respective message is displayed informing on the process status.



#### **CAUTION:**

*Balance adjustment procedure requires stable conditions (no air drafts, no vibrations), in the course of adjustment the weighing pan must be unloaded.*

### 10.2. External Adjustment

External adjustment is carried out using an external mass standard of the right accuracy and weight value, which value depends on weighing device model and capacity. The external adjustment procedure is a semi-automatic process, particular stages of which are signalled with on-screen prompts.

#### Procedure:

- Enter <Adjustment> submenu, next select < External adjustment> parameter.
- Message to remove weight is displayed. Unload the weighing pan and press  button. The balance determines start mass, message: **Start mass determination** is displayed.
- Upon completed start mass determination, message ordering you to load the weighing pan is displayed. Load the weighing pan with weight of respective mass value and press  button.
- Upon completed procedure, unload the weighing pan and press  button to confirm. Balance returns to the weighing process.

### 10.3. Adjustment Test

<Adjustment test> function enables comparing the result of an internal automatic adjustment with the value recorded in mass comparator factory parameters. The comparison is used for determining balance sensitivity drift over time.

### 10.4. Automatic Adjustment

Enter this menu to specify conditions initiating an automatic adjustment. Options:

- None – automatic adjustment inactive.
- Time – adjustment takes place in time intervals declared in menu <Automatic adjustment time>,
- Temperature – adjustment is triggered by temperature change.
- Both – adjustment is triggered by both, temperature changes and time.

### 10.5. Automatic Adjustment Time

<Automatic adjustment time> parameter determines time interval between successive automatic internal adjustments. The time interval is declared in hours and ranges between 1 and 12 hours.

To set time interval for automatic adjustment:

- Select <Automatic adjustment time> option.
- Using displayed menu, select appropriate time interval (given in hours) which is to elapse between the most recent adjustment and activation of the following automatic internal adjustment.

### 10.6. Report Printout

<Report printout> parameter determines whether or not an adjustment report is to be automatically printed upon adjustment process completion.

To print the report automatically, set the parameter as active.

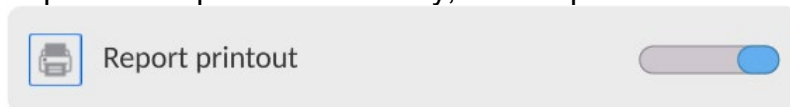

### 10.7. GLP Project

GLP is one of many methods for documenting work in accordance with adopted quality system. Data selected for printing is printed on each release of an adjustment report.

Information and signs to be used in a GLP report:

- adjustment (adjustment type)
- working mode (working mode name)
- date
- time
- balance type
- balance S/N
- operator
- Name and Surname
- level status
- nominal mass
- current mass
- difference
- nominal mass 2
- current mass 2

- difference 2
- temperature
- dashes
- empty line
- signature
- non-standard printout

## 10.8. Adjustment History

Adjustment history contains data on all carried out adjustment processes. The record is carried out automatically. Each record on adjustment comprises basic data on completed process. This menu enables displaying the list of completed adjustment processes. Each report is printable.

In order to print an adjustment report, enter <Adjustment> submenu, next enter <Adjustment history>, select adjustment to be printed. Upon displaying record details, press < > print key located on the top of the display.

### **CAUTION:**

*If the balance memory is full, the oldest record gets automatically deleted.*

If internal procedures of an organization require maintaining complete documentation concerning all carried out adjustment processes, then the list with adjustment records has to be printed and archived periodically.

### **Searching for Adjustment Record**

The module enables searching for a specific completed adjustment record. To do that, press



search button and enter date of an adjustment process that is to be found.

### **Exporting data on completed adjustment process**

Connect a USB flash drive to balance's USB port. Press < > button located on the top of the display. The process is fully automatic and on its completion a file with **.db.** extension is saved on a USB flash drive connected to the USB port.

## 11. ADMINISTRATOR PANEL

This menu enables to determine: activities to be carried out by an operator with certain permissions, password strength and permissions for unlogged operator.

**CAUTION: Only operator with Administrator permissions can modify permission-related parameters.**

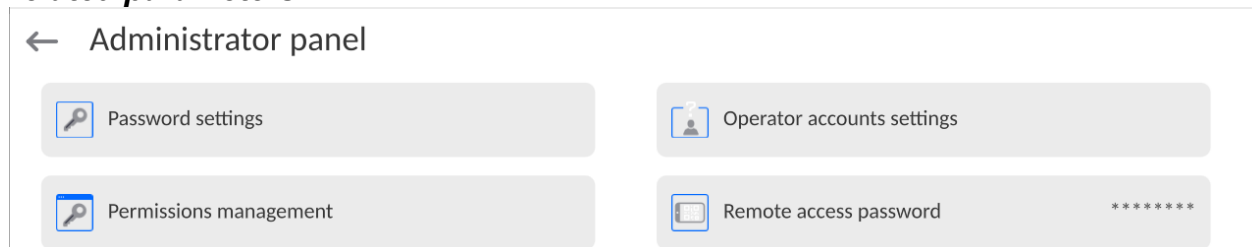

### 11.1. Password Settings

This submenu is designed to set password sophistication rate.

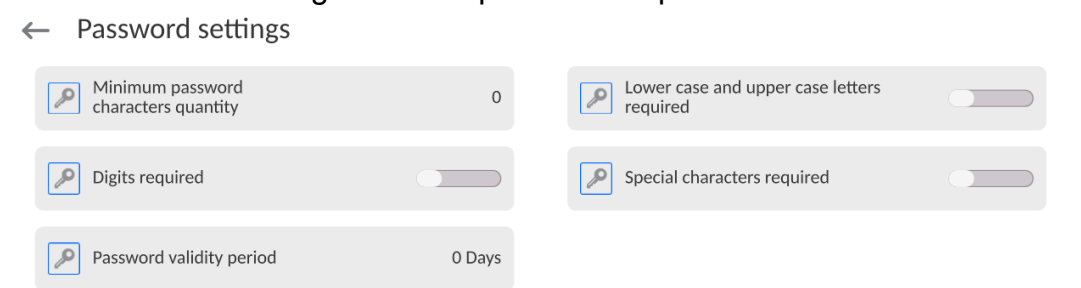

Minimum password characters quantity	Determining quantity of characters in operator's password. For '0' value set any quantity of characters.
Lower case and upper case letters required	Parameters specifying requirements regarding password characters type and format.
Digits required	
Special characters required	
Password validity period	Determining time interval in days after which the password has to be changed. For '0' entry password change is not required.

### 11.2. Operator Accounts Settings

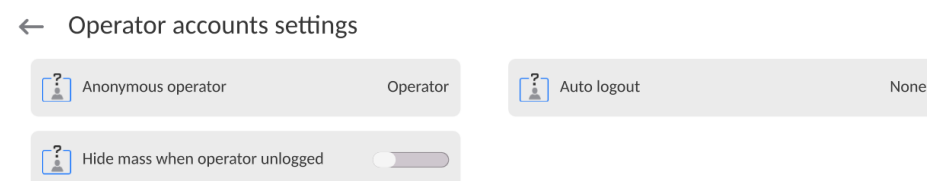

### Unlogged operator permissions

Administrator can assign an unlogged balance operator (so called anonymous operator) with permissions level.

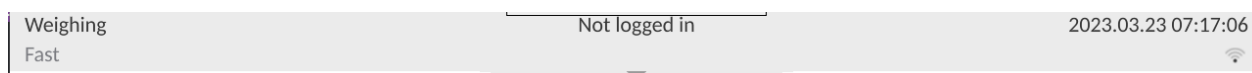

**Procedure:**

Enter <Operator accounts settings> submenu, select <Anonymous operator> option, next set respective permissions: Guest, Operator, Advanced operator, Administrator.

**Caution:** Operator assigned with <Guest> permissions level is not allowed to modify program settings.

**Auto logout**

With Auto logout function on, the operator is logged out automatically if the balance is not operated within a specified time interval, given in minutes. By default, the function is disabled (<None> entry set).

**Procedure:**

Enter <Operator accounts settings> submenu, select <Auto logout> parameter, next set respective value: none/3/5/15/30/60. Time given in [min].

**Hide mass when operator unlogged**

Option to disable the mass result display if the operator is not logged in. By default, the function is disabled.

**Procedure:**

Enter <Hide mass when operator unlogged> option and set it to active.

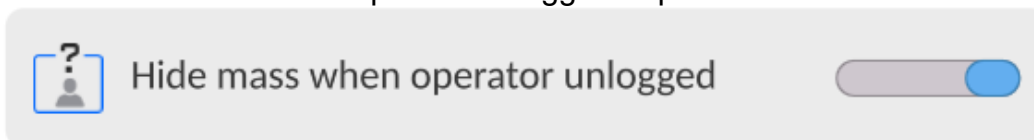

**11.3. Permissions Management**

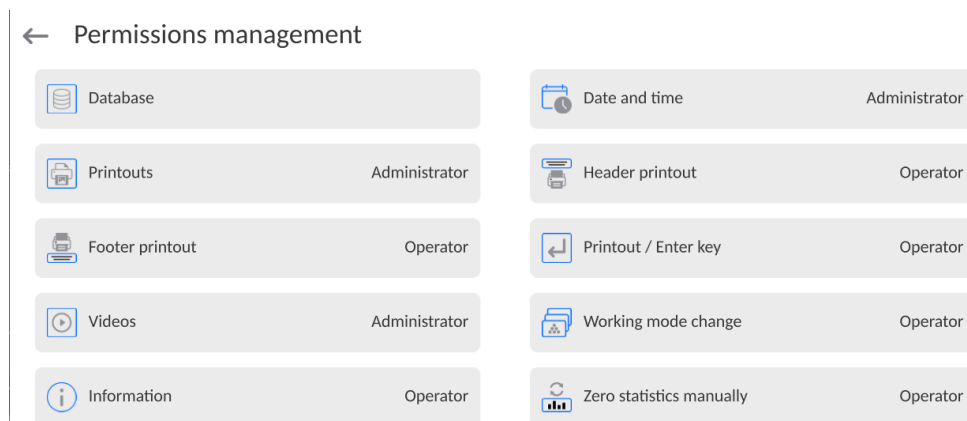

**Caution:** When the <Guest> option is set for individual parameters, their settings can be freely accessed (there is no need to log in).

Each option can be assigned with a permissions level to edit it.

### Parameter values:

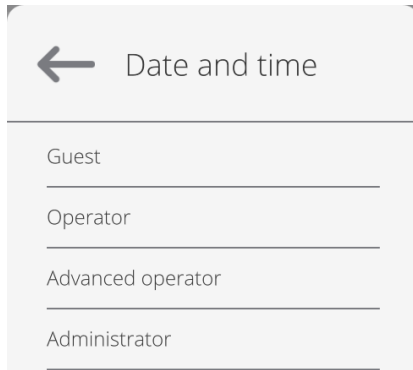

### Databases

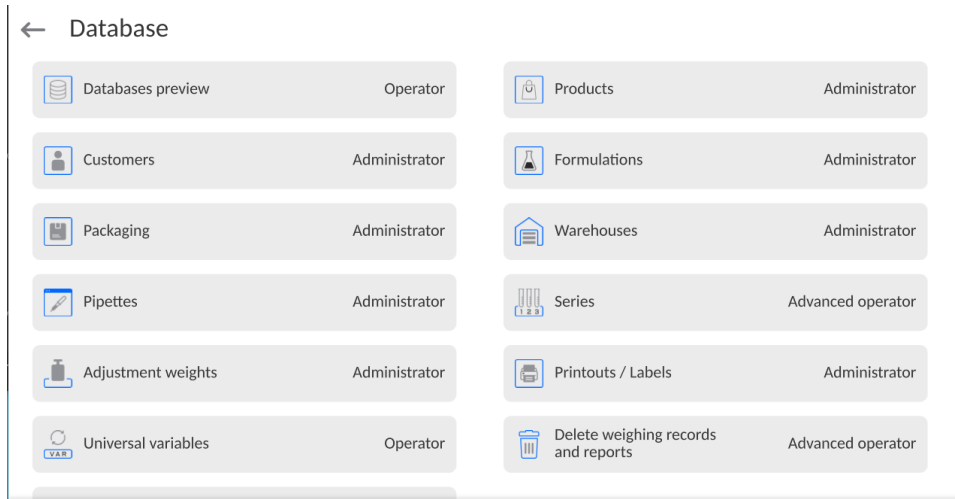

Default balance settings enable an operator who is logged as **Administrator** to modify settings of particular databases. The values can be changed depending on the needs.

The editing permissions for the other options available in this menu can be changed on a similar basis.

## 11.4. Remote access password

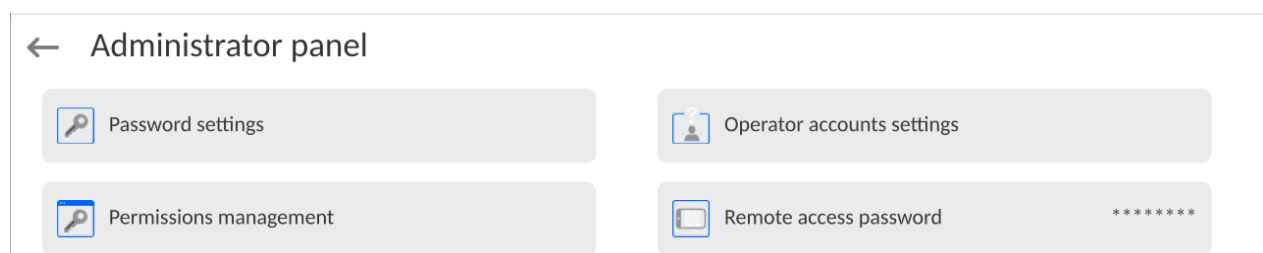

The balance allows you to gain remote access, using connection between the balance and local Internet network that a PC is connected to. The **VNC Viewer** application can be used for this purpose.

A default access password in the program is a sequence of the following characters: **radwag1234**. If the operator does not wish to use the default password, he must enter its own unique access password in the relevant field.

*Note: please remember a new password in order not to lose a remote access to the balance.*



## 12. PROFILES

A profile is a data pack that determines:

- particular function operation, e.g. 'Parts counting', 'Percent weighing', etc.,
- data to be displayed during operation,
- function keys to be active,
- measuring units to be accessible,
- criteria determining speed of operation and measurement stability,

Balance software allows you to create numerous profiles, this enables:

- designing an individual working environment by each operator,
- customized balance operation, i.e. activating selected function keys and information (improved operation performance).

For ease of operation, 4 default balance profiles have been designed. The profiles settings provide optimal weighing process for particular requirements and conditions.

Profile types:

- **Fast** – profile set to enable fast measurement of mass of any size regardless of the selected working mode. Fast profile gets activated automatically at the first balance start-up. For Fast profile, the parameters settings enable obtaining the final result as fast as possible.
- **Fast dosing** – profile intended for dosing, it is set to enable fast dispensing of product. For this profile selected, the DOSING mode gets activated automatically,
- **Precision** – profile set to enable precise measurement of mass of any size regardless of the selected working mode. For this profile the weighing process takes a lot of time, but this guarantees the most precise weighing result.
- **User** – basic profile, filters settings provide quite fast and precise measurement. For this profile selected, the WEIGHING mode gets activated automatically.

**Caution:** As an operator, you can modify all profile settings only for User profile. When it comes to the remaining default profiles (Fast, Fast dosing and Precision), they can only be modified partially. Each additional profile you created can be modified in terms of all settings.



### 12.1. Creating a Profile

The Administrator can create new profiles by:

- Copying an already existing profile and modifying it,
- Creating a new profile.



#### Copying an existing profile

**Procedure:**

- Enter the main menu, to do it press  button.
- Enter <  > submenu.
- Press and hold the profile that is to be copied.
- Menu referring to the profile record is displayed. Select <Copy> parameter.
- A new <Name copy> profile is created, new profile settings and base profile settings are identical.
- Modify necessary data: (name, etc.).

## Adding a new profile

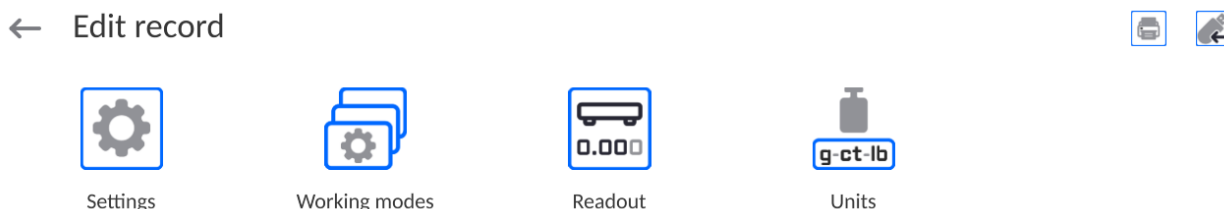

### Procedure:

- Enter the main menu, to do it press  button.
- Enter <> submenu.
- Press  button.
- A new profile is added automatically, it is opened in an editing mode.



## Deleting a profile

### Procedure:

- Enter the main menu, to do it press  button.
- Enter <> submenu.
- Press and hold the profile that is to be deleted.
- Menu referring to a profile record is displayed. Select <Delete> parameter.
- Message box: <Delete?> is displayed.
- Press  button to confirm, the profile gets deleted.

**Caution:** In order to operate profiles, it is necessary to log in as an Administrator.

## 12.2. Profile Structure

Profile parameters list:

**Settings** Enter this menu to set an individual profile name (an order of alphanumeric characters), and to declare a default working mode (the selected mode is activated as default upon selecting the profile).

**Working modes** Option to set specific functions for individual working modes. Mode submenus:

- Mode related settings
- Buttons
- Information
- Printouts

**Readout** Readout submenus:

- Filter
- Value release
- Autozero
- Autozero: Dosing
- Last digit
- Last digits quantity

- Ambient conditions
- Units** Enter this menu to declare the start unit, the supplementary unit, 2 custom units, to enter the value of gravitational acceleration force in balance's operation place and to declare availability of individual units.

### 12.2.1. Settings

#### Name

Upon entering this parameter, a message box with an on-screen keyboard is displayed.

Enter the name of a profile and press  button to confirm. The name is assigned to the profile.

#### Default working mode

Upon entering this parameter, you can select a specific working mode that is to be set as default. For <None> value set, upon selecting the profile, the balance activates the most recently used working mode.

### 12.2.2. Working Modes

Upon entering Working Modes parameter, a window containing all accessible working modes is displayed. Parameters are set for each working mode independently. Particular profile when activated runs with a given set of parameters.

List of parameters common for each working mode:

- Settings:  
specific parameters relating to a working mode, and universal settings such as: result control, tare mode, automatic footer printout, printout mode, printout.
- Functions of quick access buttons:  
declaring quick access buttons to be displayed.
- Information:  
declaring information to be displayed.
- Printouts:  
declaring type of a printout or defining a non-standard printout.

### 12.2.3. Readout

You can adjust the balance to ambient conditions (filter level) or to your own needs. <Readout> menu contains the following elements:

#### **FILTER (function disabled for Fast, Fast dosing, Precision profiles)**

Each measurement signal, before being displayed, is electronically processed in order to provide correct parameters specific for a stable measurement result (ready to be read). You can determine signal processing rate, there are five different filters:

Range:

- very fast, fast, average, slow, very slow.

While setting the filter, consider the actual operating conditions. In the case of very good operating conditions, select average or fast filter, in the case of rough conditions, select slow or very slow filter.

#### **CAUTION:**

- *For precision balances, it is recommended to select very fast, fast or average filter÷.*
- *For analytical balances and microbalances, it is recommended to select average, slow or very slow filter÷.*

### **Value release (option disabled for Fast, Fast dosing, Precision profiles)**

The parameter has been designed to determine when the stability marker is to be displayed.

There are three different settings:

- fast, fast and reliable, reliable.

**Caution:** Both parameters, filter and value release, determine how long it takes to obtain stable result.

### **Autozero function**

The function has been designed to enable automatic control and correction of zero indication.

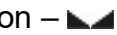
If the function is enabled, the subsequent measurement results are compared to each other in constant time intervals. If the results differ less than declared AUTOZERO range, e.g. 1 division, the balance is automatically zeroed, and the pictograms of stable indication –  and precise zero – **0** – are displayed. Active Autozero function means, that each measurement starts with the precise zero. There are, however, some cases when this function can be a disturbing factor for the measuring process, e.g. very slow placing of a load on the weighing pan (load adding, e.g. pouring, filling). In such case, the system correcting zero indication may also correct the actual indication of a load placed on the weighing pan.

Values: **NO** - autozero function disabled.

**YES** - autozero function enabled.

### **Autozero function: Dosing (option disabled for Fast, Fast dosing, Precision)**

The function has been designed to enable/disable autozero function for Dosing.

Options:

**NO** - autozero function disabled automatically when Dosing mode is run.

**YES** - autozero function enabled automatically when Dosing mode is run.

### **Last digit**

The function has been designed to enable/disable visibility of the last decimal place of measurement result. Values:

- **Always:** all digits are displayed.
- **Never:** last digit disabled.
- **When stable:** last digit displayed only when the result is stable.

### **Last digits quantity**

This function enables declaring the number of hidden last digits of the result. The function has three settings and works in connection with the <Last digit> option:

- **1:** the last digit of the result.
- **2:** the last two digits of the result.
- **3:** the last three digits of the result.

### **Ambient conditions**

Parameter relating to ambient and environmental conditions of the workstation. For unstable ambient conditions, it is advisable to set the parameter to 'Unstable' value. By default, the parameter is set to 'Stable' value.







'Stable' value results with faster operation, i.e. weighing takes much less time than in the case of 'Unstable' value set.

- **Unstable; Stable.**

### 12.2.4. Units

For a selected profile, you can declare a start unit, supplementary unit and two custom units.

#### ← Units



 Available units	 Start unit
 Supplementary unit <span style="float: right;">None</span>	 Custom unit 1
 Custom unit 2	 G-core value

Units menu enables you to enter the value of gravitational acceleration force characteristic for a particular place of use. It is obligatory should the balance be used to determine mass in [N].

#### Custom unit features:

- Formula (*custom unit recalculation formula*): Coefficient \* Mass or Coefficient / Mass.
- Coefficient (*coefficient for custom unit recalculation*)
- Name (*unique unit name to be displayed next to the result - max 3 characters*)

#### ← Custom unit 1

 Formula <span style="float: right;">Factor * Mass</span>	 Coefficient
 Name	

Newly designed custom unit name is added to the list of accessible measuring units (refers to non-verified balances exclusively).

## 13. WORKING MODES - GENERAL INFORMATION

← Working modes



Susceptibility



Weighing

### Weighing

Means of operation: weight of a load is determined through an indirect measurement. The balance measures gravitational force which attracts the load. The obtained result is processed and displayed on the balance screen in a digital format.

### Susceptibility

RADWAG-manufactured susceptometer enables carrying out measurement of magnetic susceptibility and magnetization of weights of class E1 and lower in accordance with OIML R111.

SM susceptometer is a complete reference solution for specifying the magnetic characteristics even for weights of E1 class. The instrument features user-friendly menu. Modular design, upon disassembling respective module, enables using the susceptometer as a mass comparator or a balance.

SM-UYA-6.4Y features internal adjustment option and readability of [d] 01 µg for loads within the range of 2 g to 50 kg.

Settings menu contains special functions for adapting balance operation to customer needs. They are activated upon selecting a respective profile. For detailed description of specific working mode settings refer to the given working mode section.

### 13.1. Working Modes

To run working mode other than currently operated one:

- Slide down the menu at the top of the display.

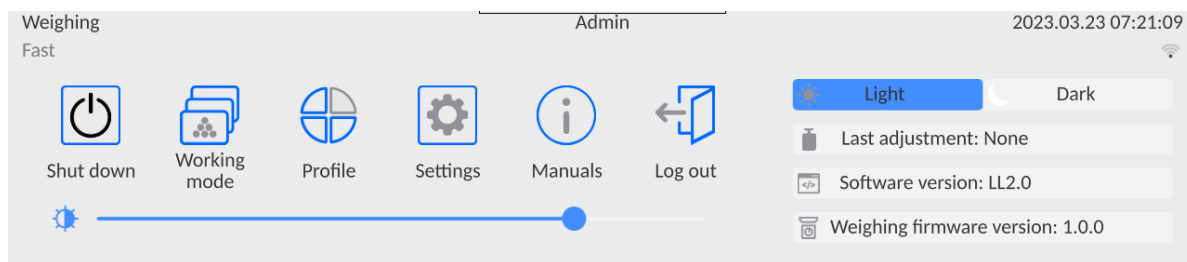

- Press <Working mode> option
- List of all working modes is displayed.
- Select the mode that is to be operated.

### 13.2. Working Mode Parameters

Each working mode has programmable parameters determining its functioning. To access particular working mode parameters:

1. Slide out the menu on the left.

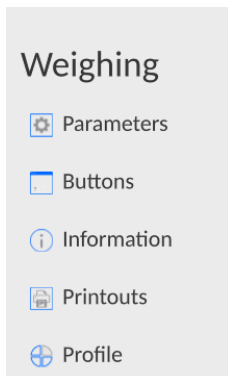

2. The following menu is displayed:

- <Parameters> - additional options.
- <Buttons> - quick access buttons configuration.
- <Information> - setting data that is to be displayed in the workspace.
- <Printouts> - setting printout type and content.
- <Profile> - profile settings

3. Enter particular submenu and select the component that is to be modified.

Description of basic parameters of <Settings> menu is to be found in section 14.7, *Additional Parameters of the Weighing Mode*. For detailed information on all but basic parameters of particular working modes, read given working mode section.

### 13.3. Quick Access Buttons, Proximity Sensors

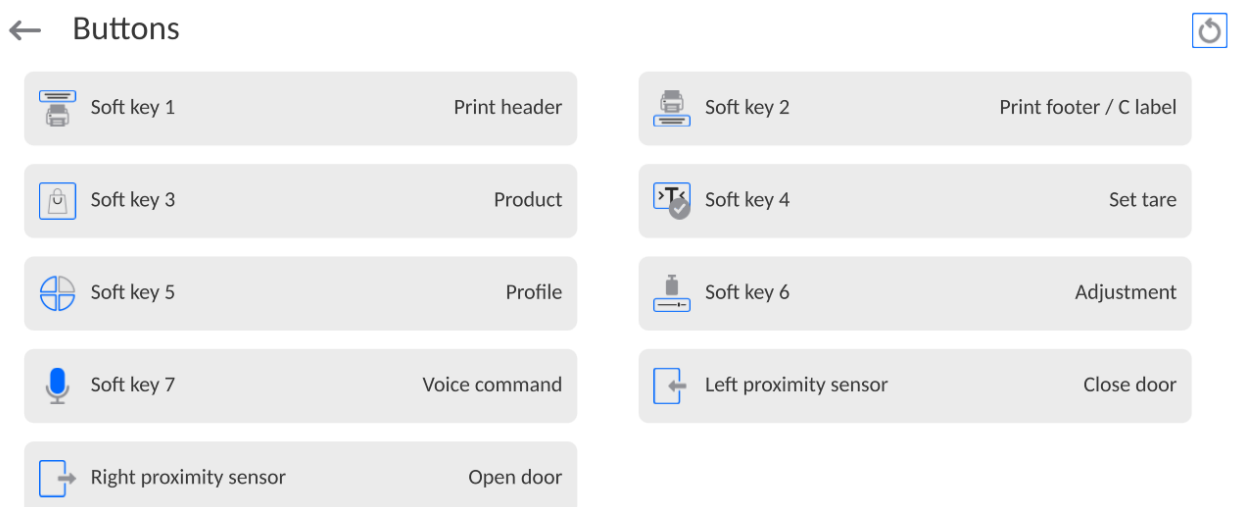

You can quickly restore default key arrangement in the bottom bar of the display, to do it click  button (top right-hand corner).

You can define up to 7 quick access buttons, which are to be displayed in the bottom bar. Upon assigning a function to a button a corresponding pictogram is displayed in the bottom navigation bar of the home screen. Each working mode features customized set of buttons. For complete buttons list, read Annex B. These are so called quick access buttons for triggering the most often performed operations.

Another way to add or change a button is to press and hold a field in the button bar for about 3s.

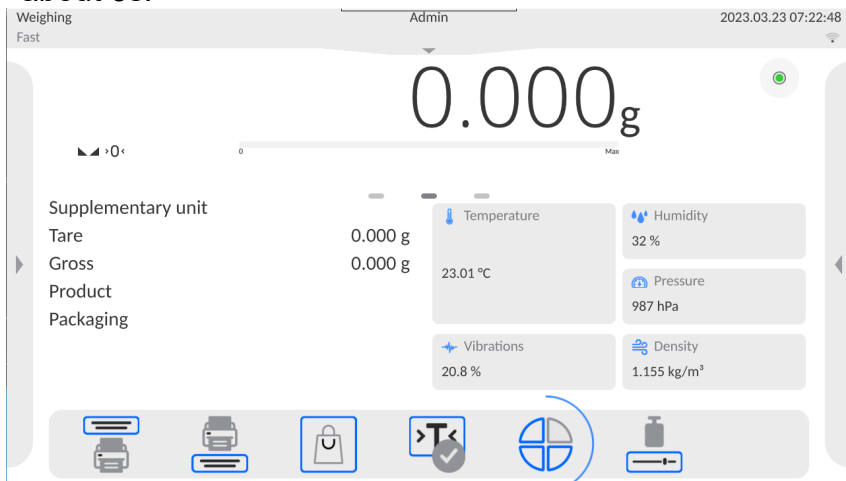

A window with the available buttons is displayed automatically.

← Available actions

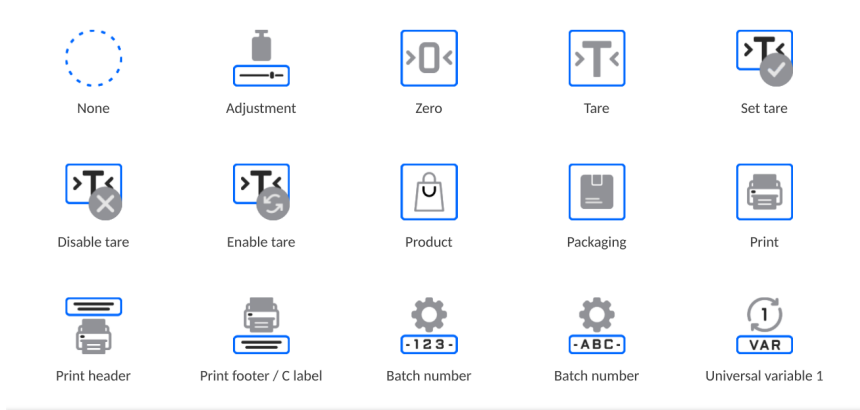

Press the respective button; the software returns to the home screen, and the selected button appears in the place where it was activated.

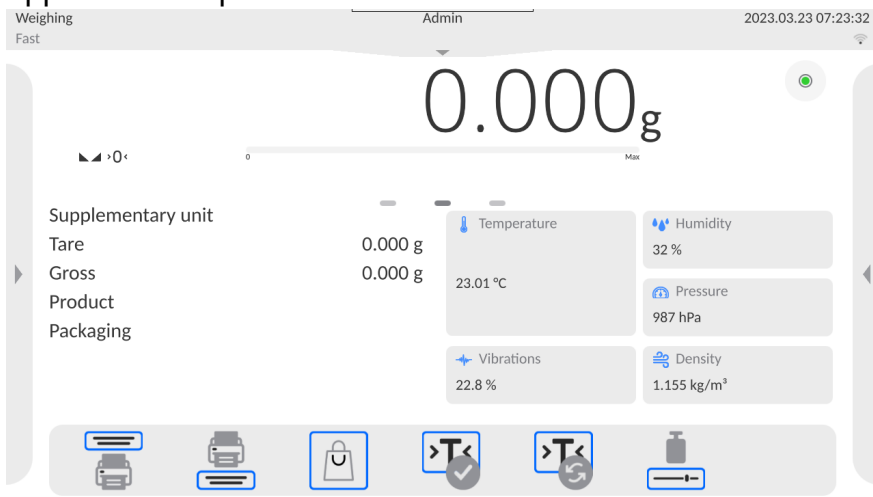

### 13.3.1. Proximity Sensors

The balance is equipped with two proximity sensors which enable touch free control. The program detects four motions performed around the sensors:



1. Hand in a close vicinity to the <Left proximity sensor>.
2. Hand in a close vicinity to the right sensor <Right proximity sensor>.

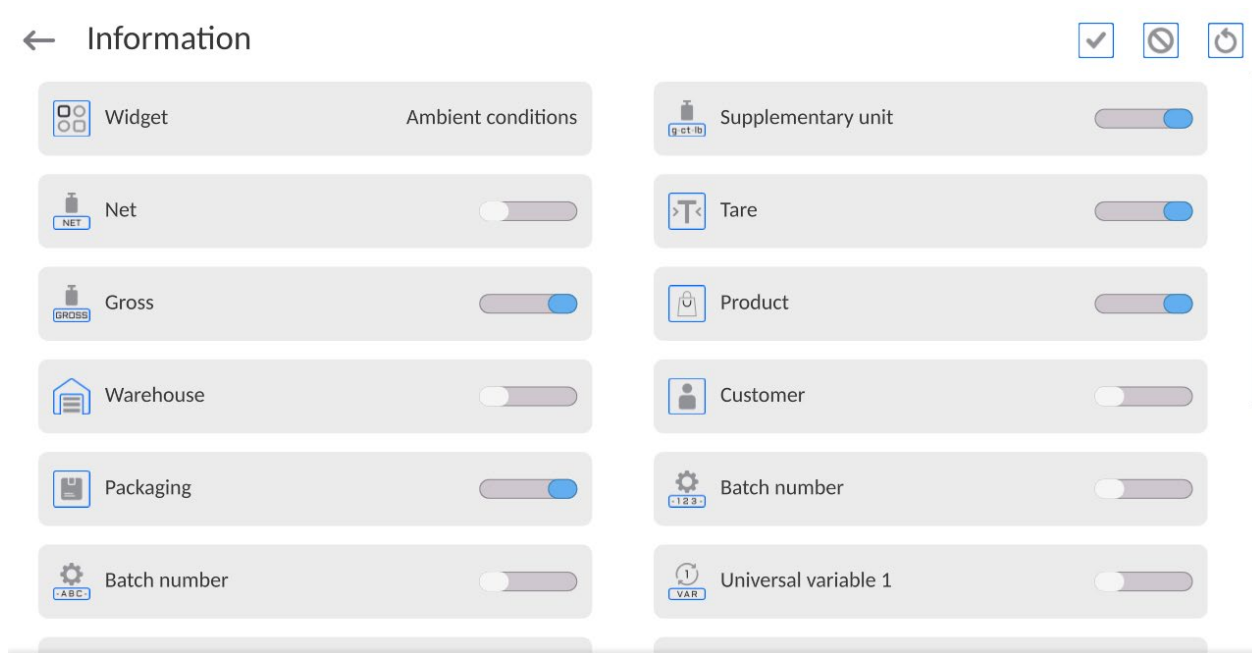

## 13.4. Information



You can quickly select/deselect info to-be-displayed, to do it use top right-hand corner buttons.

	Press to deselect all marked information.
	Press to select all marked information.
	Press to restore default settings.

Information related to the weighing process is displayed on the left side of the the display.

Supplementary unit	
Tare	0.000 g
Gross	0.000 g
Product	
Packaging	

The workspace can contain up to six data. Mind that if you select more, only the first six of them are displayed. Each parameter features two options:

-  – data enabled.
-  – data disabled.



## 13.5. Printouts

<Printouts> menu comprises three setting sections:

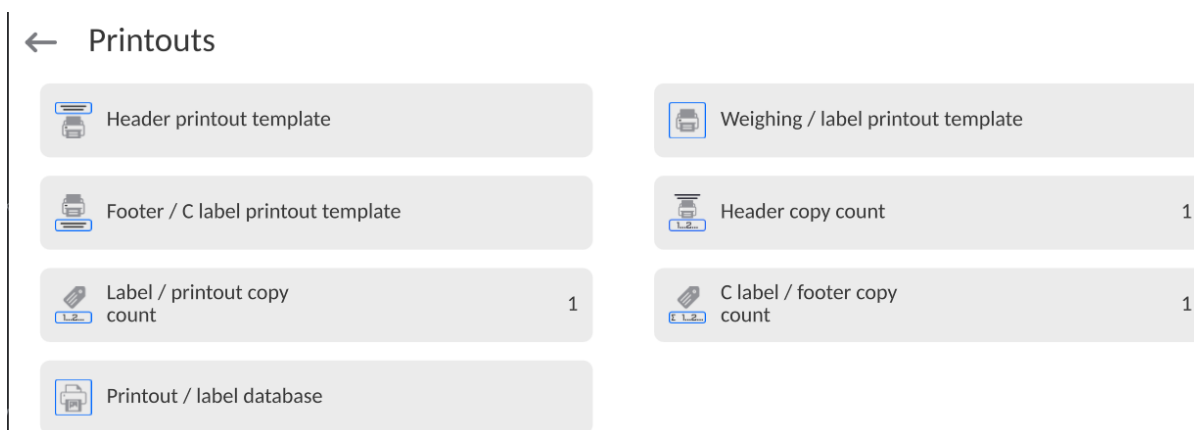

1. Standard printouts: <Header printout template >, <Weighing/label printout template>, <Footer/C label printout template>,
2. Non-standard printouts: <Printout/label database>

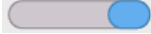
3. Parameters enabling to set how many times the header, the weighing section, the footer, is to be printed upon single pressing of the button triggering particular printouts.



**Standard printout** comprise 3 sections featuring numerous variables. Set  for each variable that is to be enabled on the printout, set  for each variable that is to be excluded from the printout.

To quickly change the settings press buttons located in the top right-hand corner.

	Press to deselect all marked variables.
	Press to select all marked variables.
	Press to restore default variables.



**Procedure:**



1. Press name of a selected template (Header – GLP Printout – Footer) and select variables that are to be printed.
2. If a printout is a non-standard one, create it.

<b><u>HEADER</u></b>	<b><u>GLP PRINTOUT</u></b>	<b><u>FOOTER</u></b>
– Non-standard printout	– Non-standard printout	– Non-standard printout
– Dashes	– N (measurement number)	– Working mode
– Working mode	– Date	– Date
– Date	– Time	– Time
– Time	– Level status	– Balance type
– Balance type	– Customer	– Balance S/N
– Balance S/N	– Warehouse	– Operator
– Operator	– Product	– First and last name
– First and last name	– Packaging	– Level status
– Level status	– Universal variable 1 ... 5	– Customer
– Customer	– Net	– Warehouse
– Warehouse	– Tare	– Product
– Product	– Gross	– Packaging
– Packaging	– Current result	– Universal variable 1 ... 5
– Universal variable 1 ... 5	– Supplementary unit	– Dashes
– Empty line	– Mass	– Empty line
– GLP report	– MW-Method	– GLP report
– Non-standard printout	– Reference tare	– Signature
	– Minimum sample	

	<ul style="list-style-type: none"> <li>- Minimum sample status</li> <li>- Mass value for a titrator</li> <li>- ID</li> <li>- Non-standard printout</li> </ul>	<ul style="list-style-type: none"> <li>- Non-standard printout</li> </ul>
--	---	---

## HOW TO OPERATE PRINTOUTS

1. In order to print variables of the GLP PRINTOUT section, press  button on the operation panel; only variables with  attribute can be printed (see the above list).
2. Variables with  attribute, present in the HEADER and FOOTER, are printed **ONLY** upon pressing **PRINT HEADER** and **PRINT FOOTER** pictograms. The pictograms have to be added to the bottom bar of the display as quick access buttons.  
(For detailed instruction on how to add quick access buttons to the bottom bar of the display, go to section 12.3)

	
Print header data	Print footer data

### CAUTION:

*Measuring units for mass indication:*

- Net – the main measuring unit (adjustment unit)
- Tare – the main measuring unit (adjustment unit)
- Gross – the main measuring unit (adjustment unit)
- Current result – currently displayed measuring unit
- Supplementary unit – supplementary measuring unit
- Mass – the main measuring unit (adjustment unit)

### Non-standard printout

Non-standard printout may contain: TEXTS and VARIABLES (acquired from the software during printout). Each non-standard printout is a separate project, featuring a specific name by which it is identified and saved to the database of printouts.

### Procedure:

1. Press <Non-standard printout> entry.
2. Press <Add>  button, window featuring Name/Code/Project data opens.
3. Set name and code of a printout.
4. Press <Project> button.
5. Printout edit box with an on-screen keyboard is displayed.
6. Use the keyboard to design printout template, the printout may contain texts and variables.

### CAUTION:

- It is possible to add a printout by import of configured texts from flash drives connected to balance's USB port.
- Printout's name is ONLY a NAME, and it is not part of its content.
- For information on how to design a non-standard printout template, read section 28.10 Printouts.



## 13.6. PROFILES

Profiles function has been described in section 12 Profiles.

## 14. WEIGHING

Load the weighing pan. Wait for a stable indication (display of stability marker, ) and read the measurement result.

Record/printout of the measurement result is available on pressing  key:

- for non-verified balances – stable and unstable measurement results are saved or printed (regardless of stability marker  absence). For unstable measurement result question mark  is printed next to the mass value.

### 14.1. Weighing Unit Selection

Change of weighing unit is carried out by pressing the weighing unit pictogram visible next to the value of measurement result. Upon pressing the weighing unit, list of available units is displayed. Select the unit you need, the software automatically recalculates indicated value.

Units list:

<i>unit</i>	<i>denotation</i>	<i>unit</i>	<i>denotation</i>
gram	[g]	Taele Hongkong	[tlh]
milligram	[mg]	Taele Singapore	[tls]
carat	[ct]	Taele Taiwan	[tlt]
pound	[lb]	Taele China	[tlc]
ounce	[oz]	Momme	[mom]
ounce Troy	[ozt]	Grain	[gr]
pennyweight	[dwt]	Newton	[N]
		Tical	[ti]

### 14.2. Good Weighing Practice

To assure long-term operation and correct mass measurements, follow the rules presented below:

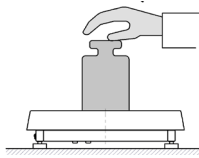
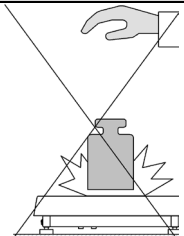
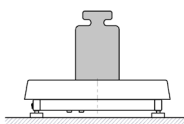
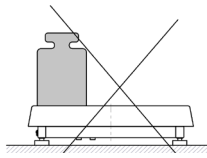
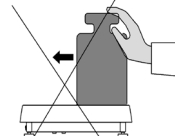
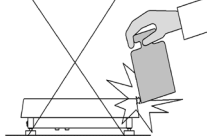

- Start the balance with no load on the weighing pan (permissible value of load on the weighing pan at start is  $\pm 10\%$  of the maximum capacity).

YES	NO	YES	NO
			
Load the weighing pan steadily avoiding shocks. Setup/Misc./Vibrations detection parameter enables control of weighing pan loading (section 21.8).		Place weighed loads centrally on the weighing pan	
NO	NO	NO	NO
			
Avoid side loading, in particular side shocks			

### 14.3. Level Status



The balance is equipped with an AutoLEVEL System which enables monitoring of the balance level. Level monitoring is performed uninterruptedly in the course of balance operation. Level status is signalled with a respective pictogram, displayed in the upper right corner of the work panel. The system monitors balance level state and on detecting any change the position of level marker is displayed on the screen and/or respective alarm is activated. Balance level setting proceeds.

#### Levelling procedure:

- Press level status  pictogram located on the top of the display.
- Control panel of level function is displayed. Along with the level indicator, balance view is presented.
- Level the balance by turning its feet left/right, follow the blinking pictograms,  – press to make level marker move toward the centre of the circle.
- When the marker takes central position, its colour turns from red to green – the balance is correctly levelled.

**Caution:** *The balance is equipped with Automatic Level Control mechanism. For detailed information regarding the mechanism operation refer to section 21.9 of this user manual.*



### 14.4. Zeroing

To zero mass indication press  key. Zero indication and the following pictograms are displayed:  and . Zeroing operation means determining new zero point, recognized by the weighing instrument as precise zero. The instrument can be zeroed only when the indication is stable.

#### **CAUTION:**

*Indication can be zeroed only within  $\pm 2\%$  range of maximum capacity. If the zeroed value is above  $\pm 2\%$  of the maximum capacity, then the software indicates a respective error message.*

### 14.5. Taring

To determine net weight value, load the weighing pan with a packaging, wait for a stable indication and press  key. Zero indication and the following pictograms are displayed: **Net** and . Upon unloading the weighing pan, the sum of tared masses with minus sign is displayed. You can assign tare value to a particular product stored in the database. In such case the assigned tare value is automatically acquired upon selection of the given product.

#### **CAUTION:**

*It is impossible to tare negative values. When you try to tare negative values, the weighing instrument responds with an error message. In such case, zero the indication and repeat taring procedure.*

## Entering tare value manually

### Procedure:

- Press quick access button. The button is available regardless of the working mode you



operate.

- An on-screen numeric keyboard is displayed.
- Enter tare value and press  button.
- Balance returns to weighing mode. Tare value with „-“ sign is displayed.

## Deleting tare

The tare value indicated on the display can be deleted by pressing key on the operation panel, or by using programmable <Deactivate tare> function button.



**Procedure 1** - upon taking the tared load off the weighing pan:

- press  key,
- the <Net> marker gets deleted, new zero point is determined.

**Procedure 2** - with tared load on the weighing pan:

- press  key,
- the <Net> marker gets deleted, new zero point is determined.
- when the tare value exceeds 2% of the maximum capacity, -Err- message is displayed in order to inform you about the fact that operation cannot be carried out.

**Procedure 3** - when the tared load is on the weighing pan or upon taking the tared load off the weighing pan:

- press  <Deactivate tare> programmable button,
- the NET marker is deleted.
- the display indicates tare value.
- to restore the last tare value press  <Restore tare> button.

## 14.6. Use of Air Buoyancy Compensation Factor

The application enables correcting mass measurement errors in the course of:

1. weighing loads of density considerably different from the density of standard that has been used to adjust the balance; typically the balance is adjusted with a steel mass standard with density  $\sim 8.0\text{g/cm}^3$  or a brass mass standard with density  $\sim 8.7\text{g/cm}^3$ ; if loads made of other substances are weighed, then ratio indicated on the graph below applies.

## Error value in relation to density of weighed sample

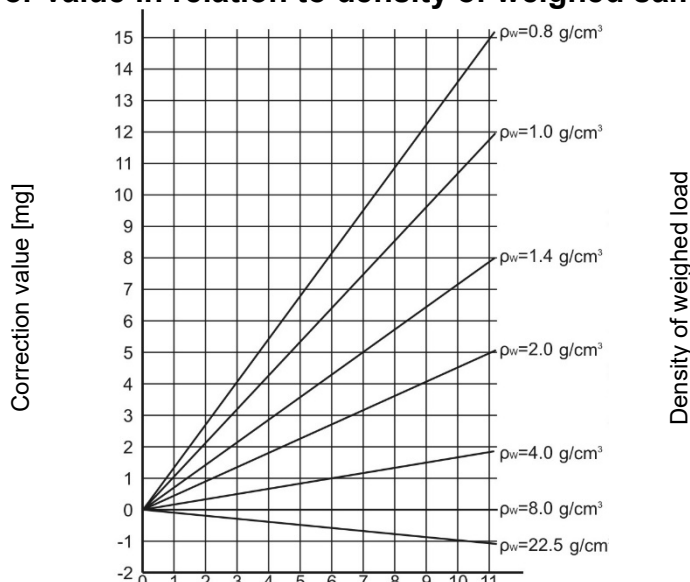

The graph presents correction values for versus the density of weighed load, assumption that air density is constant and equals  $1.2 \text{ kg/m}^3$  is taken.

- testing sample mass change within a few hours long period of time for a case when the sample mass is relatively constant (minor changes). It is assumed that air density changes affect considerably the final result, wherein the density is influenced by changes of pressure, temperature and humidity.

In order to carry out a reliable measurement it is necessary to know the measuring methods, features of tested sample, ambient conditions, air density in the laboratory room and density of weighed sample.

## FUNCTIONING

The air buoyancy compensation procedure is to be used as follows:

- Method 1:
  - Enter air density value and value of weighed sample density to balance's memory.
  - Wait, the software automatically calculates the correction factor for weighed mass, next corrected value of weighed mass is displayed.
  - In order to avoid mistakes, the corrected mass value is accompanied by <!> symbol, the symbol is visible on a display and a printout.
- Method 2:
  - Determine air density value with use of module program (semi-automatic operation) and enter value of weighed sample density to balance's memory.
  - Determination of air density is carried out using a set of two mass standards, one made of stainless steel, and the other one of aluminium. Based on mass indications of the two standards, the software automatically calculates the air density and saves the value in balance's memory on operator's confirmation. Now, enter value of weighed sample density to balance's memory.
  - Wait, the software automatically calculates the correction factor for weighed mass, next corrected value of weighed mass is displayed.
  - The corrected mass value is accompanied by <!> symbol, the symbol is visible on a display and a printout.

In order to enable/disable the air buoyancy compensation procedure go to the user menu. The procedure is valid for weighing mode exclusively.

## 14.7. Additional Parameters for a Weighing Process

Modification of the weighing functions enables programming balance operation.

### Procedure:

- Slide out the menu.
  - The following submenus are displayed: Settings, Buttons, Information, Printouts.
  - Enter particular submenu and select the component that is to be modified
- <Settings> - additional options related to the weighing mode,  
<Keys> - defining quick access buttons,  
<Information> - supplementary data on the weighing process displayed in an Info field,  
<Printouts> - selecting printout type,  
<SETTINGS> - weighing-process-related data such as:

#### – Tare mode

Available options:

- SINGLE  
mass value saved to the balance memory on single pressing of the TARE key. Subsequent pressing of the TARE key determines a new tare value. Selecting a product or packaging to which a tare value is assigned causes automatic deleting of the previously assigned tare value.
- CURRENT SUM  
total value of currently entered product and packaging tare values (result of selection of product and packaging from the database) with possibility to add tare value entered manually. When a new tare value for a product or packaging is set again, then the tare value entered manually gets deactivated.
- TOTAL SUM  
total value of all entered tare values.
- AUTOTARE  
Means of operation:  
Each first stable measurement result is tared. The NET sign is displayed. Now you can determine the net mass of the weighed load. Upon unloading the weighing pan and autozeroing, the tare value is automatically deleted.
- EACH MEASUREMENT:  
possibility to tare prior to each measurement in the series.

#### – Automatic footer printout

Available options:

MODE – None – manual footer printout,

Sum of measurements – footer is printed when mass value entered in <Threshold> parameter gets exceeded.

Measurements quantity – footer is printed when a pre-defined measurements quantity (a batch) set in parameter <Threshold> is carried out.

THRESHOLD – setting the threshold value determining footer printout.

For <Sum of measurements> parameter, threshold value is determined in measuring unit [g], for <Measurements quantity> parameter the unit is not determined; the provided value specifies carried-out measurements quantity.



## – Printout / Release mode

- PRINT/RELEASE BUTTON (manual operation)
  - Never – printout disabled.
  - First stable – first stable measurement is recorded.
  - Each stable – all stable measurements are recorded.
  - Each – printout of all measurements (stable and unstable); for verified balance, only stable measurements are printed out (as in <Each stable> setting).
- AUTOMATIC MODE
  - Never – printout disabled.
  - First stable – first stable measurement is recorded upon loading of the weighing pan with a load; record of the next stable measurement result takes place only if the following conditions are met: weighing pan gets unloaded, measurement value lower than the value of the set threshold is displayed, a new load is placed on the weighing pan.
  - Last stable – last stable measurement, registered prior to unloading, is recorded. The record takes place only if the following conditions are met: weighing pan gets unloaded, measurement value lower than the value of the set threshold is displayed.
  - With interval – select this value to start automatic printout and record of indications to the WEIGHINGS database, carried out periodically in a specified time intervals. The interval is set in [min] in <INTERVAL> parameter. Interval range is 1 s - 9 h 59 min 59 s.

**Caution:** Each weighing result is printed and recorded (stable and unstable for a non-verified balance; stable for a verified balance).

Automatic operation with interval starts at the moment of switching the function on. The first stable weighing result of a value greater than the THRESHOLD value is printed and recorded as the first measurement. The following measurements are printed with frequency set in INTERVAL parameter. To stop the automatic operation with interval, switch the option off.

- THRESHOLD:  
Mass value obligatory for operation of automatic printout, set in grams.
- INTERVAL  
Record frequency for automatic operation with interval

## – Statistics

settings for statistical calculation during operation.

Options:

- Global: statistical calculations are performed for all successive measurements, regardless of the selected product.
- Product: statistical calculations are performed for particular products.

## – Air buoyancy compensation

Parameters allowing you to switch on the compensation and to enter weighed sample density data and air density data.

**Caution:** Function valid for the weighing mode exclusively. For detailed information regarding the operation and settings, refer to the previous section of this user manual.

## 14.8. Ambient Conditions - Vibrations

Vibrations are a major cause of errors. Since vibrations spread in all directions, vibration analyzers and meters must carry out measurements in three axes concurrently. Ambient conditions module implemented in RADWAG balances of 5Y series features such option. Analytical balances are precise weighing instruments; therefore, even insignificant oscillations influence their operation. Humans are most often unable to sense vibrations. In order to detect them, it is necessary to use special equipment. Vibration sensor, along with a module that analyses the influence of the vibrations onto the measurement, informs the user in real time on the possibility of occurrence of errors caused by high-frequency vibrations. Usually the vibrations are dampened with use of anti-vibration tables. A signalling device, i.e. ambient conditions module equipped with a vibration sensor, is used to support the process of vibrations dampening. Such device comes standard with each 5Y series balance. With use of the said signalling device, it is possible to evaluate workstation conditions and, if necessary, to find more convenient place of use. It is often impossible to find a place where no vibrations occur, however the signalling device allows the operator to determine when and where to expect vibrations of the lowest-frequency.

Due to the following 3 factors: specified values of free vibrations, resolution, and permissible weighing instrument errors, the analysis must be carried out with regard to the right effective value (rms value) and bandwidth. Such analysis is performed on each 5Y series balance in real time.

In the case of the module that is an integrated part of the balances manufactured by RADWAG, the filters analyse those frequencies to which the weighing devices are sensitive. In the case of balances, effective value (rms value) measured from 3 axes and for a particular time interval is given, such value provides information on amplitude and history of disturbances.

Radwag has designed an analysis method and selected permissible vibration thresholds respectively to make signalling device operation both effective and convenient (not troublesome). Balance screen displays balance-registered vibration level in percent.

Vibration threshold cannot be changed, however the operator can modify settings in a way ensuring that alerts are displayed in the most convenient way, depending on the needs. By default, the set value is 100%.

Example of settings modification:

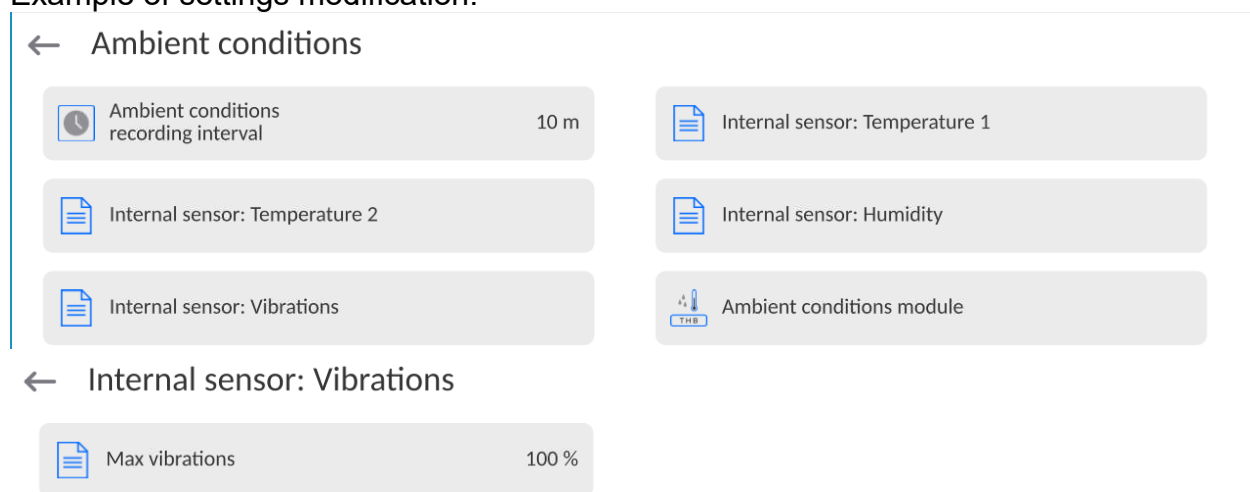

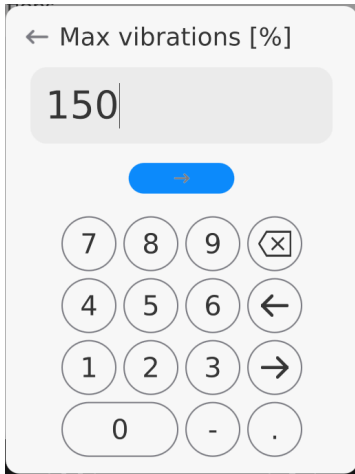

← Internal sensor: Vibrations

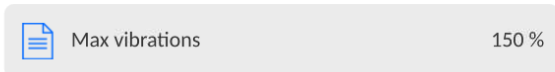

For better understanding, analyse the following example (the values used below are exemplary ones, they were not taken from the balance).

1. Assumed vibration threshold set by default on 5Y series balance: 100 mm/s<sup>2</sup>.
2. Max vibrations value: 100% (threshold for alert– pictogram colour change, from green to red). Pictogram colour is green for vibrations within 0 – 100 mm/s<sup>2</sup> range, for vibrations value of 101 mm/s<sup>2</sup>, the pictogram changes to red.
3. Max vibrations value: 150%. Pictogram colour is green for vibrations within 0 - 150 mm/s<sup>2</sup> range, for vibrations value of 151 mm/s<sup>2</sup>, the pictogram changes to red.

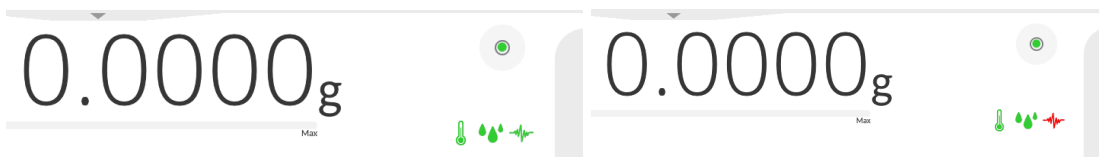

Vibrations are signalled by a respective pictogram displayed in the weighing result window.

A window with the current sensor values is presented in the middle of the display on the right. Displayed vibration value (Vibrations) is the effective value registered within the most recent 2 seconds. This value is refreshed every 2 seconds. If the screen displays 100%, this means that vibrations have reached the threshold set by RADWAG.

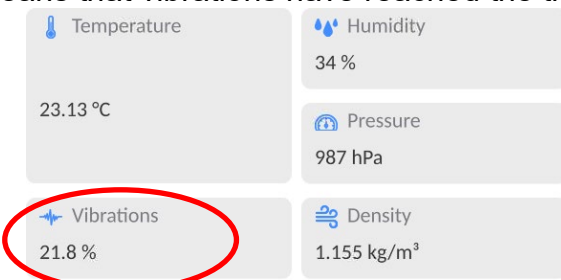

Vibrations are recorded in the database, this allows to analyse the history of ambient conditions quality.

## ← Ambient conditions



2023.03.21 09:26:48	2023.03.21 09:24:52
2023.03.21 09:22:38	2023.03.21 09:20:12
2023.02.27 10:03:21	2023.02.27 09:56:31
2023.02.27 09:52:41	2023.02.27 09:50:27
2023.02.27 09:44:50	2023.02.27 09:42:30
2023.02.27 09:38:53	2023.02.27 09:27:36

## ← Edit record



Date	2023.03.21 09:27:00	Air density	1.155 kg/m <sup>3</sup>
Temperature 1	23.13 °C	Temperature 2	23.57 °C
Humidity	34 %	Pressure	987 hPa
Vibrations	0 %		

The effective value of vibrations registered by the balance over a declared time interval is saved (from the moment of the last record) – Setup/Ambient conditions/Ambient conditions recording interval.

## ← Ambient conditions

Ambient conditions recording interval	10 m	Internal sensor: Temperature 1	
Internal sensor: Temperature 2		Internal sensor: Humidity	
Internal sensor: Vibrations		Ambient conditions module	

By default, the interval is set to 10 min; this value may range between 1 - 60 min. Record analysis allows the user to select the optimal time of the day for the measurements to be carried out, i.e. the time when the ambient conditions influence the vibrations the least. Mind that there are places where the most convenient working conditions occur after-hours.

Along with each measurement, data on ambient conditions alerts and level of vibration that occurred in the course of the measurement are saved.

← Weighing records



2023.03.21 09:34:49	19.993 g	2023.03.21 09:34:42	10.001 g
2023.03.21 09:34:35	0.806 g	2023.03.21 09:34:30	1.477 g
2023.03.21 09:34:29	1.477 g	2023.03.21 09:34:24	0.671 g
2023.03.21 09:34:24	0.671 g	2023.03.21 09:34:18	1.477 g
2023.03.21 09:34:11	0.806 g	2023.03.21 09:34:04	0.670 g
2023.03.21 09:33:56	10.001 g		

← Edit record



Air buoyancy compensation	No	Product	
Operator	Admin	Customer	
Working mode	Weighing	Warehouse	
Packaging		Result control	
Level status	Yes	Ambient conditions alerts	No
Air density	1.155 kg/m <sup>3</sup>	Vibrations	34.3 %
ID	2	Weighing platform number	1

## 15. MAGNETISM

**CAUTION: Prior to measurement, carry out internal adjustment.**

Prior to measurement, set mass standard support plate depending on the test weight, so that the distance between the test weight and the magnet is compliant with the requirements.  
For mass standards of class E1 - 20 mm distance (marking Z1 on the plate).  
For mass standards of class E2- 27 mm distance (marking Z2 on the plate).  
For mass standards of class F1 and F2 - 43 mm distance (marking Z3 on the plate).

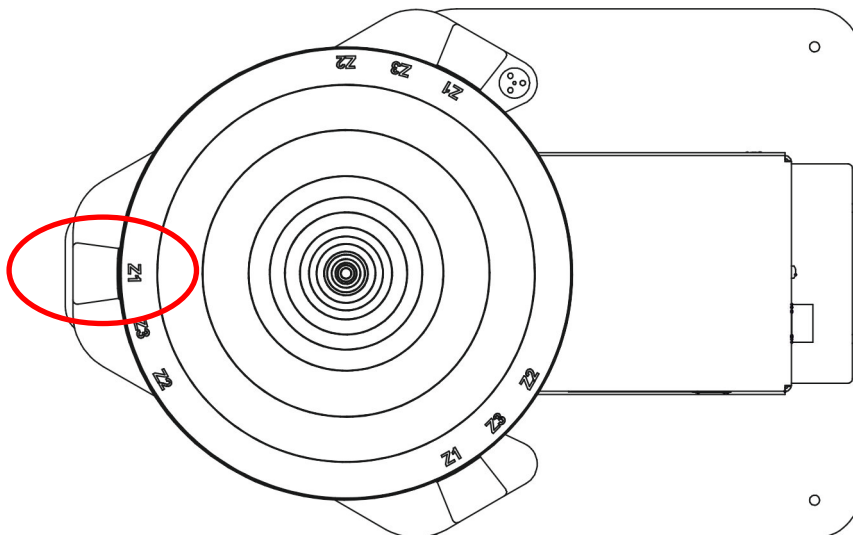

Enter respective settings in the program, according to the test weight: class, height, diameter and mass of the test weight.  
If a series of test weights of the same class and dimensions is to be tested, determine and enter their quantity in <Test weights quantity> parameter.

← Parameters

Weight class	E1 (Z1 = 20 mm)	Weight height	0 mm
Weight diameter	0 mm	Weight mass	0 g
Test weights quantity	1	<input checked="" type="checkbox"/> Start	

← Parameters

Weight class	E1 (Z1 = 20 mm)	Weight height	88 mm
Weight diameter	48 mm	Weight mass	1000 g
Test weights quantity	1	<input checked="" type="checkbox"/> Start	

Upon entering respective values, you can return to the home screen and carry out weighing.

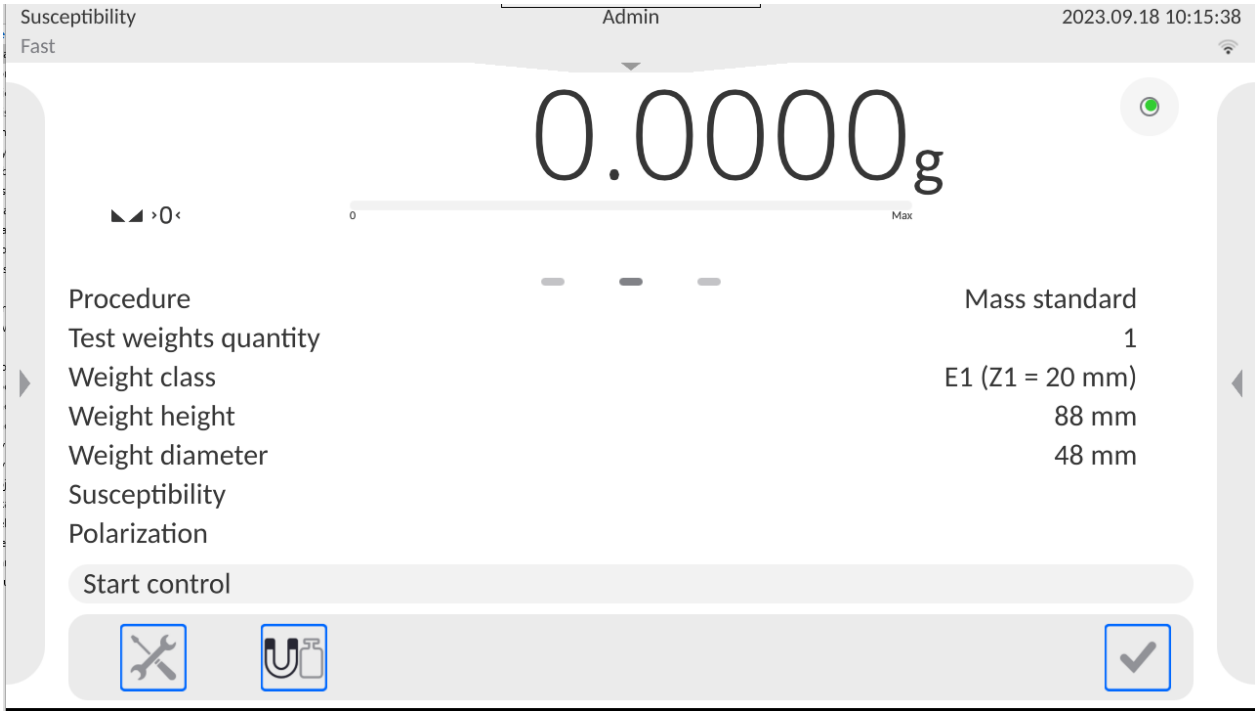

Press  button.

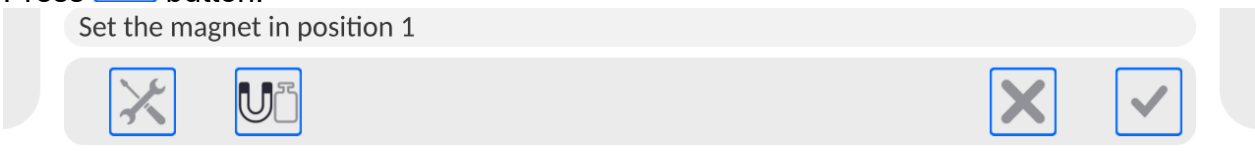

A message to set the magnet to position 1 is displayed. Press  button to confirm. The indication is automatically zeroed and the first step of the procedure is started. A message to load the test weight onto the spot marked on the bracket plate is displayed.

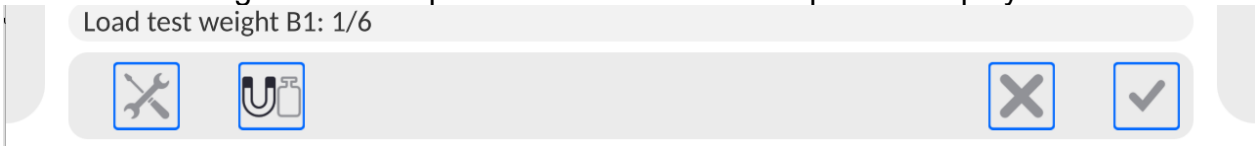

Wait for a stable indication and press  button to confirm. The measurement is saved to the database. The following message is displayed:

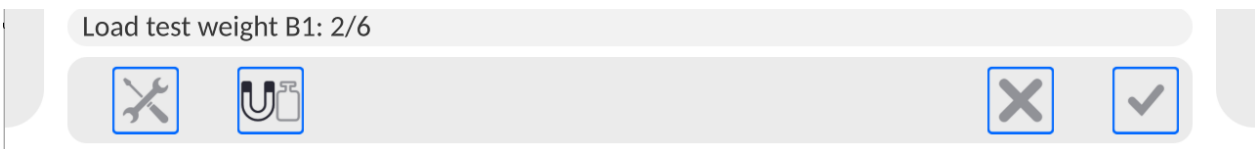

Unload the plate, wait until zero is displayed. Load the weight again, wait for indication stabilization and confirm the measurement.

Repeat the procedure. Carry out 3 measurements for the first position of the magnet.

Upon confirmation of the third measurement, message to change magnet position is displayed.

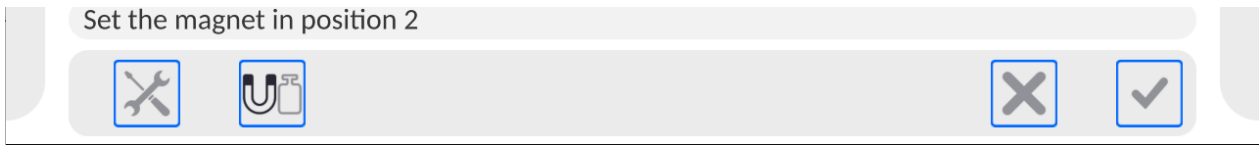

Remove the plate, change magnet position, install the plate in the previous position and press  button to confirm.

The indication is automatically zeroed and the next step of the procedure is started. A message to load the test weight onto the spot marked on the mass standard support plate is displayed.

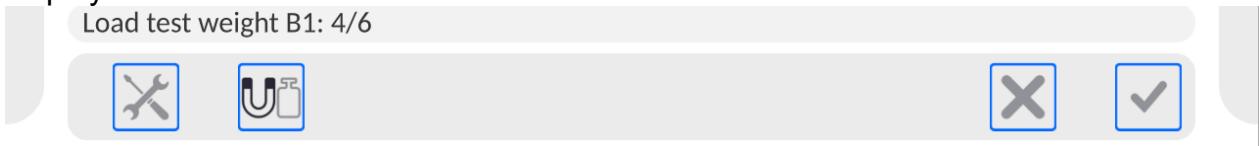

Upon magnet position change, carry out 3 subsequent measurements.

Upon the last measurement confirmation, respective calculations are automatically carried out. The results are displayed on the grey workspace and saved to <Susceptibility: reports> entry. If report printout option is selected in the settings, the report is automatically printed.

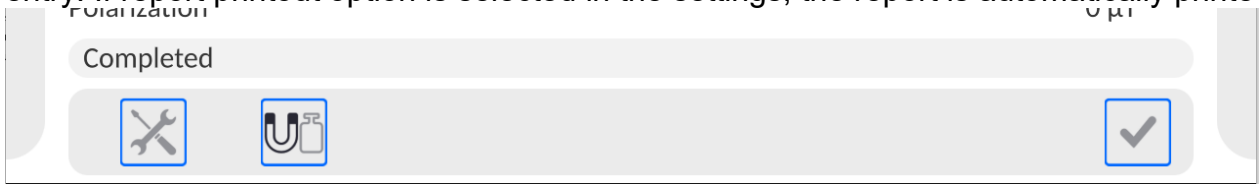

Prior to next measurement press  button to confirm.

If a series of test weights is to be measured, set respective value in <Test weights quantity> parameter.

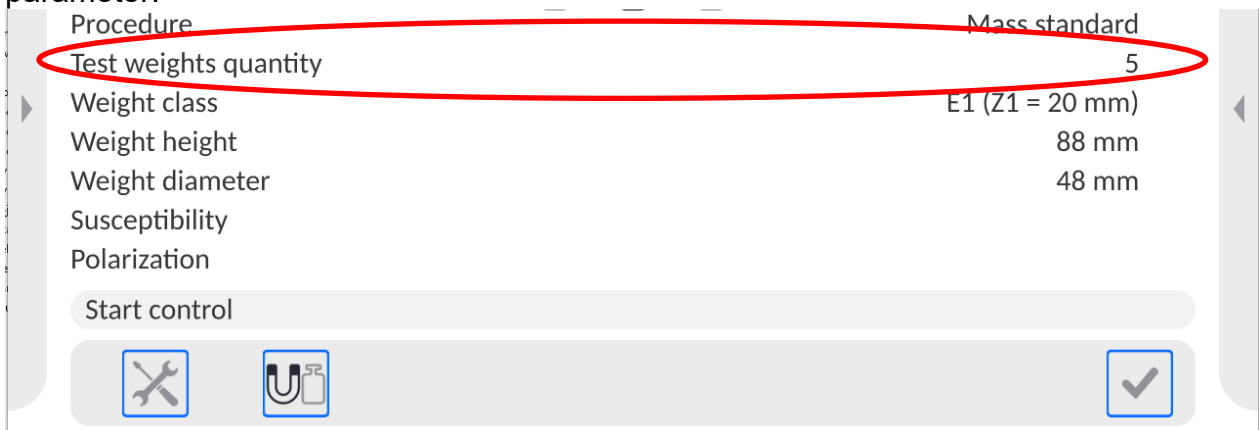

If the value is different than 1, carry out measurement of all test weights contained in one series for the first position of the magnet. Then change magnet position to 2 and carry out the measurement of test weights. Remember to carry out the measurement in the same order as for the first position of the magnet.



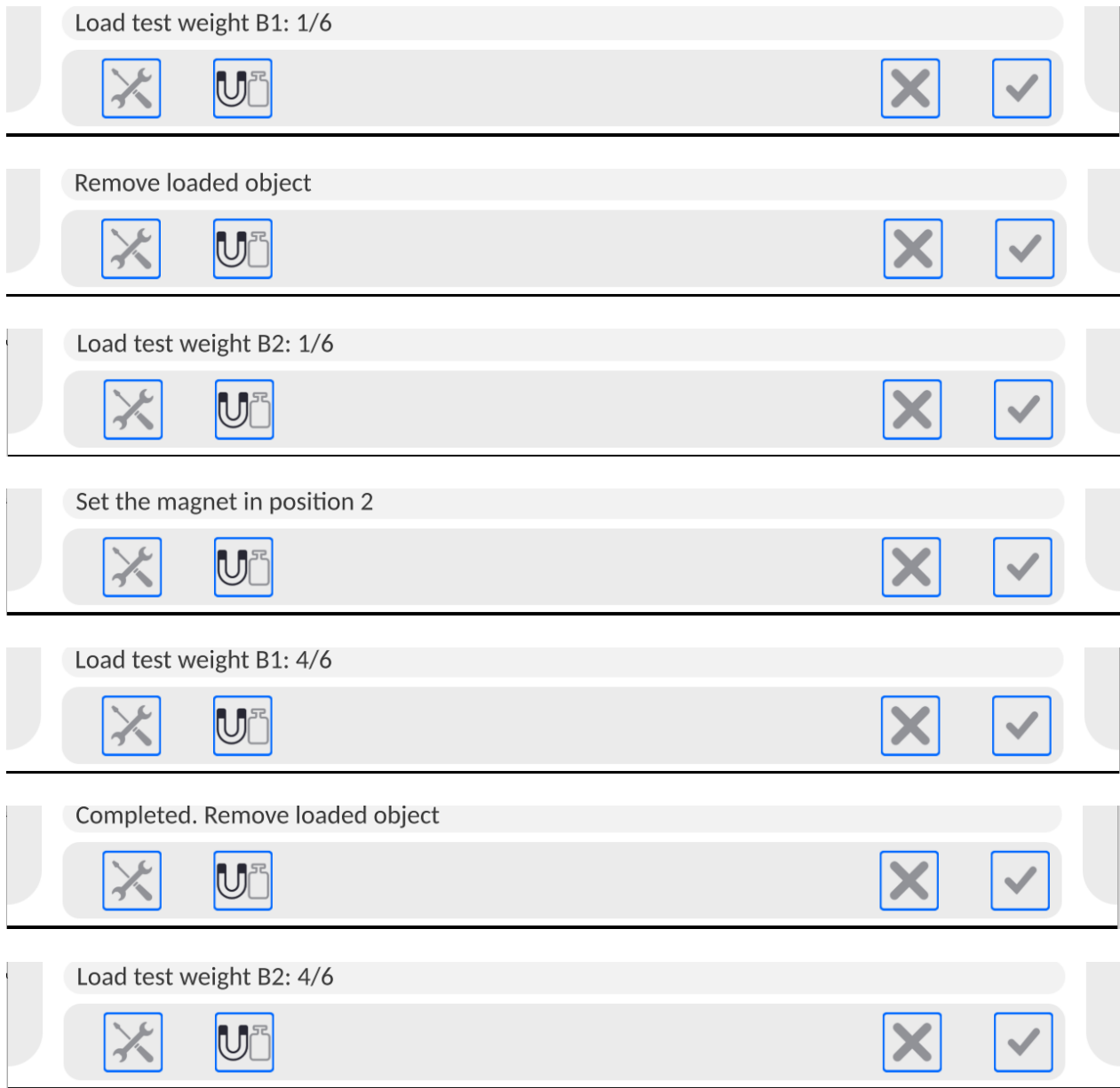

### 15.1. Printouts

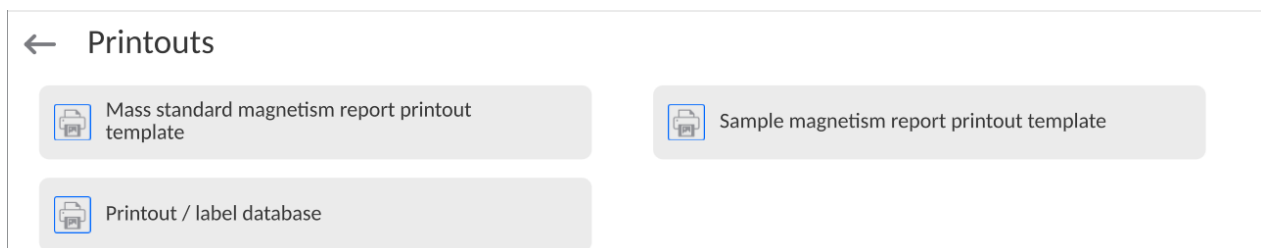

Printouts option enables you to determine the content of a particular standard printout, and to define a non-standard printout.

- **Standard printout** comprises four internal blocks, each containing different variables. Variable settings: YES - print; NO - do not print.

Settings for header, GLP, and footer printouts are specified in section 13.5. For settings for mass control report, read below. You can design report content.

**CAUTION:**

In order to specify what measurement data is to be printed on a report, it is necessary to modify settings for <Mass standard magnetism report printout template> parameter. To enable particular measurement data printout, set <YES> value for it.

Report content:

← Mass standard magnetism report printout template

Working mode <input checked="" type="checkbox"/>	Date <input type="checkbox"/>
Time <input type="checkbox"/>	Balance type <input type="checkbox"/>
Balance S/N <input type="checkbox"/>	Operator <input checked="" type="checkbox"/>
Name and Surname <input type="checkbox"/>	Procedure <input checked="" type="checkbox"/>
Start date <input checked="" type="checkbox"/>	End date <input checked="" type="checkbox"/>
Test weights quantity <input checked="" type="checkbox"/>	Weight class <input checked="" type="checkbox"/>
Weight height <input checked="" type="checkbox"/>	Weight diameter <input checked="" type="checkbox"/>
Weight mass <input checked="" type="checkbox"/>	Susceptibility <input checked="" type="checkbox"/>
Susceptibility status <input checked="" type="checkbox"/>	Polarization <input checked="" type="checkbox"/>
Polarization status <input checked="" type="checkbox"/>	Empty line <input checked="" type="checkbox"/>
Dashes <input checked="" type="checkbox"/>	Signature <input checked="" type="checkbox"/>
Non-standard printout <input type="checkbox"/> None	

**15.2. Performed Mass Control Report**

Upon each completed control process, a report is generated. The report is saved to the <Susceptibility reports> reports database. Report files are named by the date and time of a particular process performance.

## 16. DATABASES

The balance features the following databases:

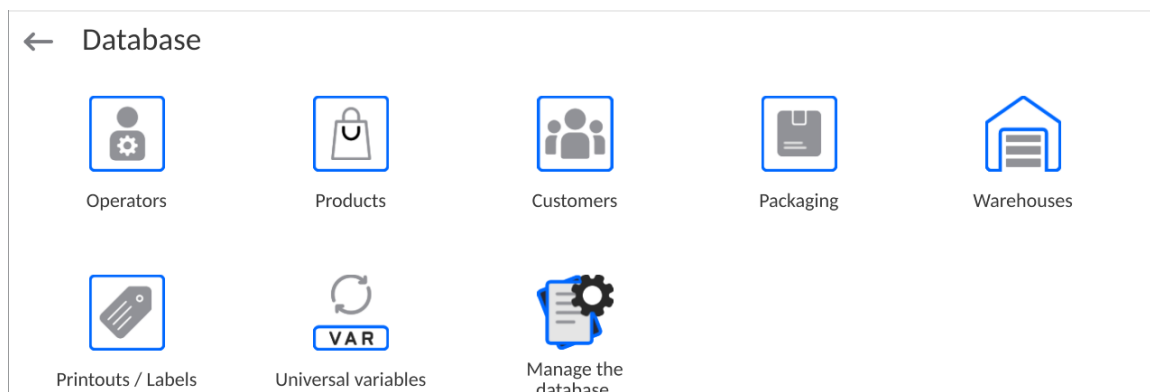

### 16.1. Database Operations

**Databases can be operated** only by an authorized personnel.

Procedure:

- Press and hold a respective database pictogram.
- Database menu is displayed.
- Select one of the available entries (entries set is conditioned by a database).

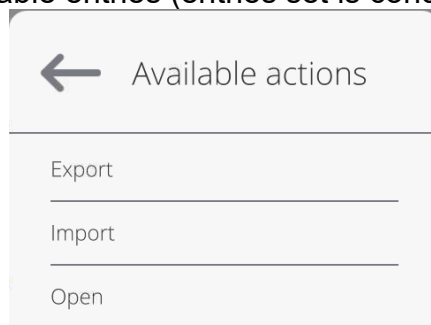

Entries:

- EXPORT - select to export data from a selected database to a USB flash drive. Plug the USB flash drive to a USB port; upon its detection, the software automatically starts a copying process. Upon completion of the copying process, a window with both, a file name to which data have been saved and message: <Completed> is displayed. Confirm completion.
- IMPORT – select to import data from a USB flash drive. Plug the USB flash drive to a USB port; upon its detection, a window with a list of saved files is displayed. Select file with data to be imported. The copying starts automatically. Upon completion of the process, message: <Completed> is displayed. Confirm completion.
- OPEN – select to enter a database (alternative method for database entering: single click on a given database field).

List of typical database operations:

1. Adding entry to a database.
2. Searching for a record in a database by name.
3. Searching for a record in a database by code.
4. Searching for a record in a database by date.
5. Exporting database content to a USB flash drive via USB port.
6. Printing data on a specific record in a database.

The above processes are initiated by dedicated buttons located on the top of the display. Follow the displayed commands.

## 16.2. Operators

Operators database features list of users permissioned to operate the balance. The following data can be defined for each balance operator:

ID	Name
Code	Password
First and last name	Permissions
Active account	Language
Default profile	Card number
Theme	

**CAUTION: Only a user with Administrator status can add new operators or delete operators from the database.**

In order to add an operator:

- Enter <Operators> menu, press <  > button.
- Define all necessary data.

**Caution:** It is possible to search for an operator in a database of operators by code or name.

### Log in using a transponder card:

**Caution:** The RFID reader mounted in the indicator operates at a frequency of 13.56MHz and complies with ISO/IEC 14443 Type A. Only cards of this standard will be recognised by the reader.

- Enter Operator settings.
  - Select <Card no.>

← Card no.

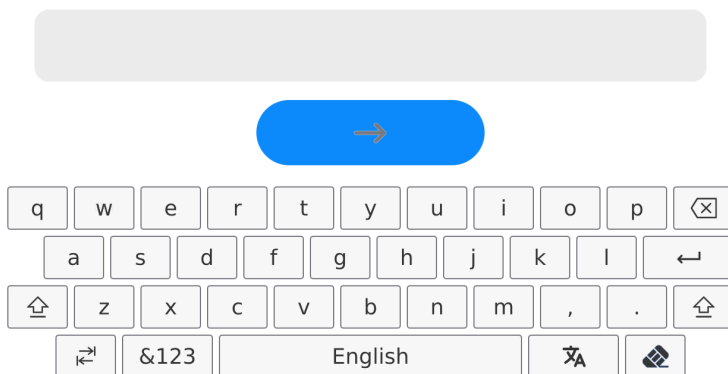

The screenshot shows a user interface for entering operator settings. At the top, there is a grey text input field labeled '← Card no.'. Below the input field is a blue rounded rectangular button with a white arrow pointing to the right. Below the button is a virtual keyboard with keys for letters, numbers, and symbols. The keyboard is organized into rows: the first row has letters q, w, e, r, t, y, u, i, o, p and a delete key; the second row has letters a, s, d, f, g, h, j, k, l and a backspace key; the third row has a shift key, letters z, x, c, v, b, n, m, comma, period, and another shift key; the bottom row has a backspace key, a '&123' key, a language key labeled 'English', and a keyboard layout icon.

- Apply the card to the RFID reader.

- The card number is automatically entered in the editing field.

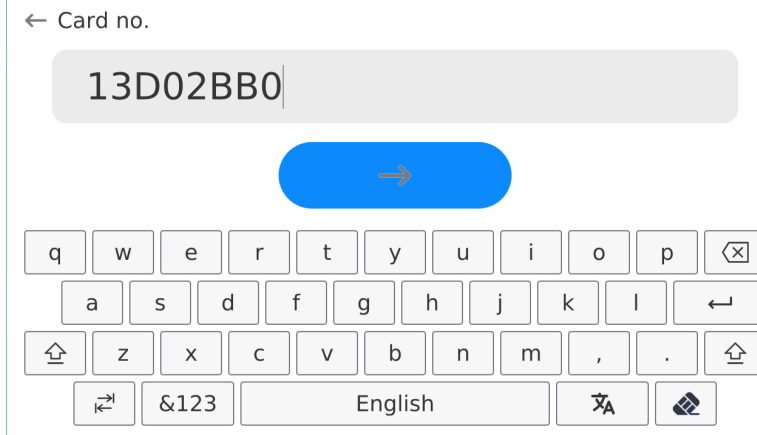

- Press  button, the card number is added to the operator settings.

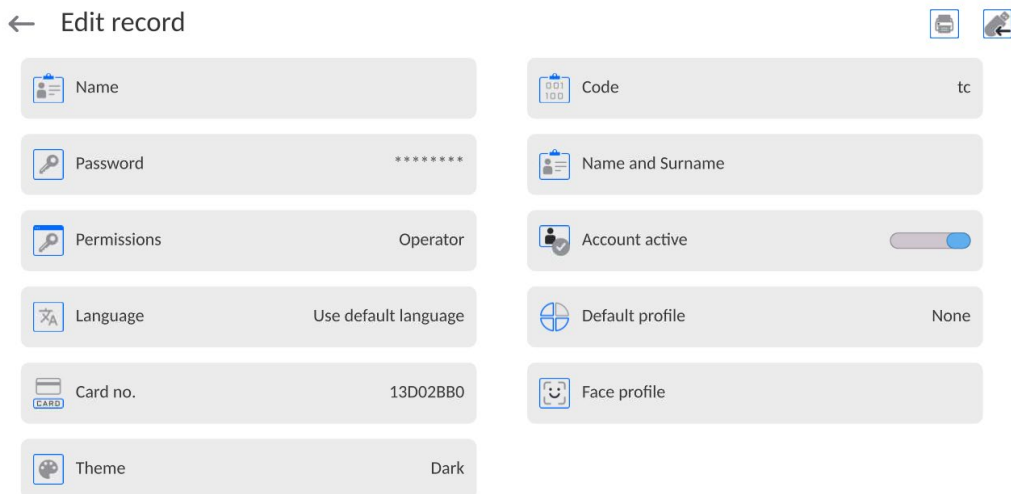

- Exit to the home screen. From now on, applying this card to the RFID reader will automatically log the user in.

### Log in using a fingerprint:

**Caution:** Only the fingerprint reader listed as a dedicated accessory for these balances can be connected to the balance. A list of accessories can be found on RADWAG website.

- When the fingerprint reader is connected to the USB type A socket, the <Fingerprint> option appears in the operator settings menu.

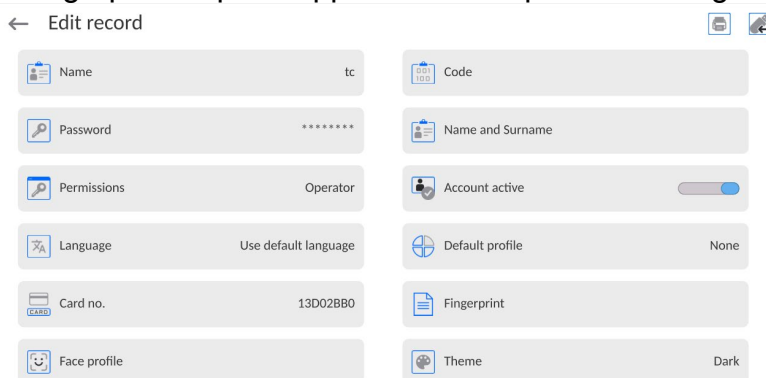

- To add a fingerprint for an operator, enter this option.

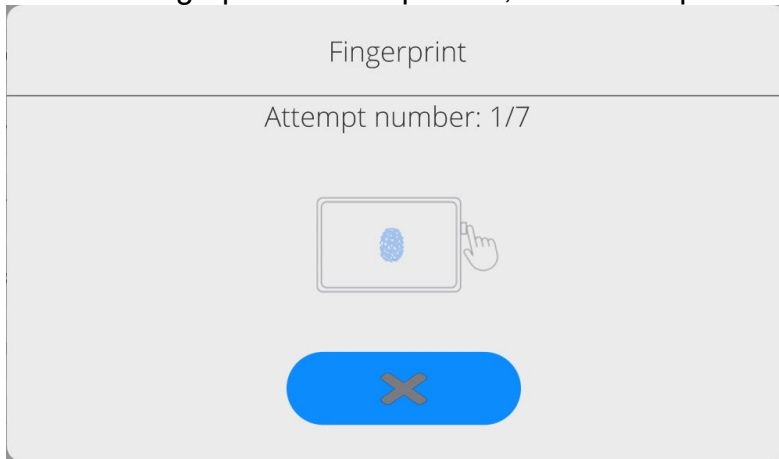

- Scan the fingerprint and repeat the procedure 7 times (as described in the message box).
- When the procedure is completed correctly, a summary window is displayed.

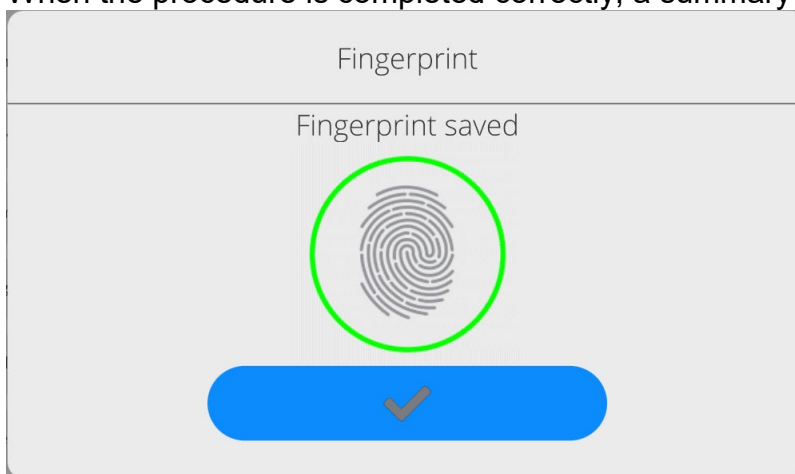

- Confirm the procedure by pressing  button.
- From now on, if a fingerprint reader is connected to the USB port, a pictogram of the active fingerprint login option is displayed in the login window.

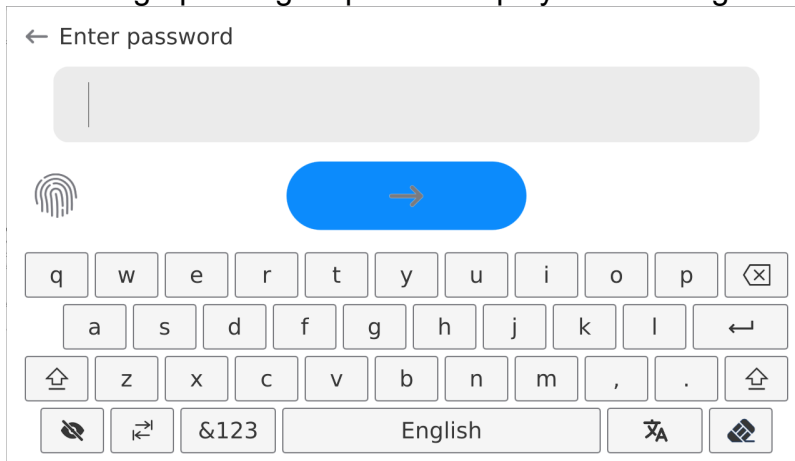

- After placing a finger on the reader and confirming the correctness of the fingerprint with the stored pattern, the pictogram briefly turns green, the user is automatically logged in, and the software switches to the home screen. The name of the logged-in user is displayed in the top bar of the window.
- If the scanned fingerprint does not match the stored pattern, the pictogram briefly turns red, the user is not logged in, and the software displays the login window.

## Log in using a face profile:

- To add a face profile for a user, go to the option presented below

← Edit record 🖨️ 🗑️

Name tc	Code tc
Password *****	Name and Surname
Permissions Operator	Account active <input checked="" type="checkbox"/>
Language Use default language	Default profile None
Card no. 13D02BB0	Face profile
Theme Dark	

- After starting the option, a message is displayed and the face profile is read; you must position yourself correctly in relation to the camera so that the program can save the profile.

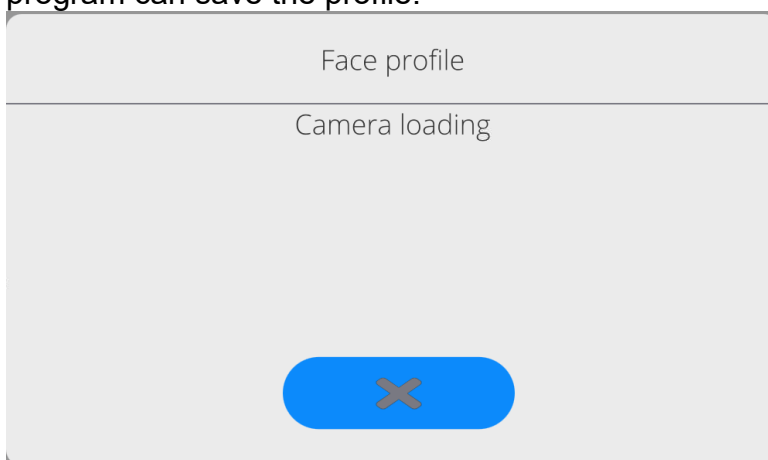

- Once the profile has been saved, a message is displayed along with a picture from the camera.

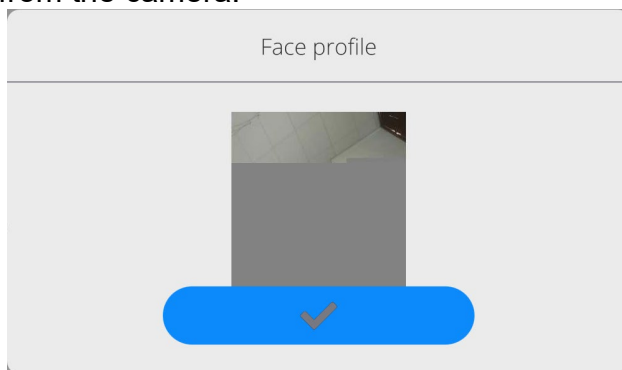

- Press  button to close the window.

- The option description in the user settings changes to <Delete face profile>, indicating that the profile is stored in the balance memory.

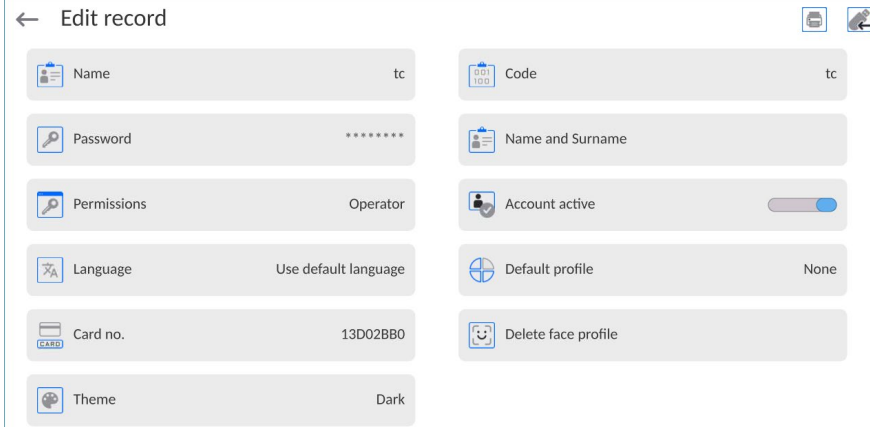

- From now on, if the user for whom the face profile was added logs in, after entering the logging window, the program will automatically read the profile, which will be signalled by the pictogram on the left side of the window

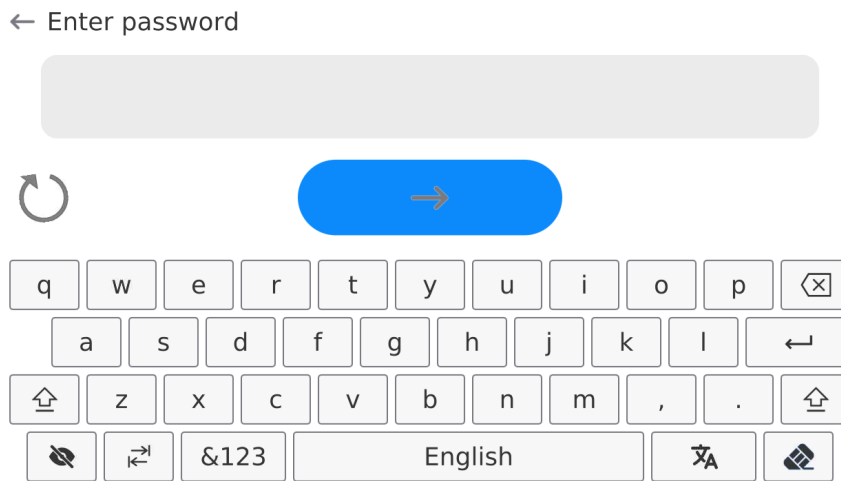

- The program automatically reads a photo of the user's face profile, and after the photo is read, the camera turns on (which is indicated by the lighting of a diode next to the camera) and compares the saved photo with the profile read by the camera. If these images match, the main program window will open and the name of the logged-in user is displayed in the top bar of the window.

#### Editing data on an operator:

- Press field with operator name.
- Data on a specific operator is displayed.
- Select and change necessary data.

#### To delete an operator:

- Press and hold operator name.
- Database menu is displayed.
- Select <Delete> parameter and confirm.



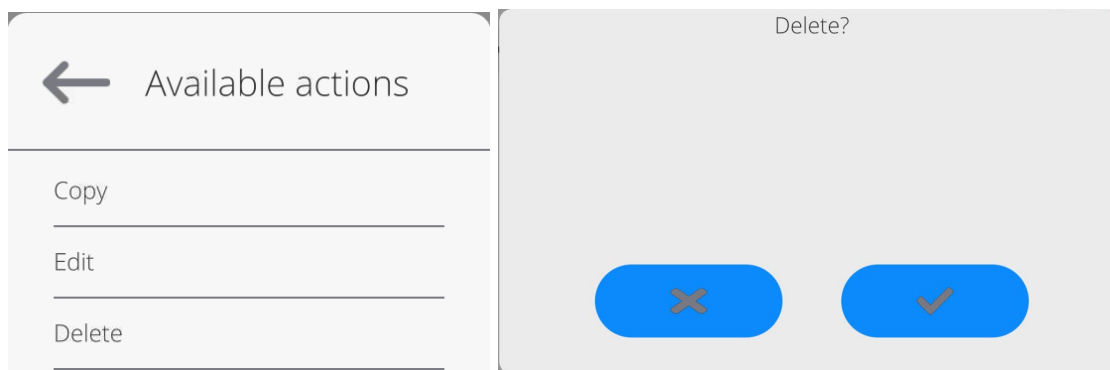

### 16.3. Products

<Products> database contains names of all products that are weighed, counted or controlled.

#### Procedure:

- Enter <Databases> submenu, press < Products> entry.



- Press  < Add> button to add a new product to the database, or
- Select the already existing product.

#### List of parameters defined for a product:

- |                 |   |
|-----------------|---|
| 1. ID           | [Unique product number]   |
| 2. Name         | [Product name]  |
| 3. Description  | [Product description]   |
| 4. Code         | [Product code]  |
| 5. EAN code     | [Product EAN code]  |
| 6. Mass         | [Unit mass of a product]  |
| 7. Dosing speed | [Option available for the <Mass control> mode; determines feeder dosing speed in [%] (0% - 100%).The value of dosing speed is conditioned by the size, shape and mass of dispensed parts (pills); it has to be determined by tests] |
| 8. Min          | [Minimum mass for weighing the product using result control thresholds – LO. Value of <T1-> error for <Mass control> mode determined as percent of the nominal mass]  |
| 9. Max          | [Maximum mass for weighing the product using result control thresholds – HI. Value of <T1+> error in the <Mass control> working mode determined as percent of the nominal mass]   |
| 10. Tolerance   | [% value calculated versus mass (5), denoting measuring area in which the measurement is recognized as correct.]  |
| 11. Tare        | [Product's tare value, set automatically on selecting a product from the database]  |
| 12. Price       | [Unit price of a product]   |

- |  |  |
|--|--|
| 13. PGC mode                               | [Control mode: Non-destructive average tare, Non-destructive empty – full, Destructive full – empty, Destructive empty –full.])  |
| 14. Batch portion                          | [Measuring batch for control: Non-destructive empty - full, Destructive full – empty, Destructive empty –full.]  |
| 15. SQC: Unit                              | [Product measuring unit]   |
| 16. Batch quantity                         | [Option available only for the <PGC> mode; specifies the quantity of controlled product batch]   |
| 17. Interval of average tare determination | [Option available only for the <PGC> mode; specifies the minimum time interval needed for estimation of a packaging average tare; given in [h]; if the software detects that pre-set time interval has passed, it displays a message: <b>&lt;Estimate average tare&gt;</b> . The message has an informative character and you can decide whether to carry out the process or not.] |
| 18. Packages quantity                      | [Option available only for the <PGC> mode; specifies the number of packagings needed for estimation of the average tare]   |
| 19. Internal control                       | [Option available only for the <PGC> mode; allows for specification of internal control criteria accordant with company standards for a given product]   |
| 20. SQC                                    | [Option available only for the <SQC> and <Mass control> modes; allows for specification of internal control criteria accordant with company standards for a given product]   |
| 21. Density                                | [Product density, used as a sample density for compensating air buoyancy] - [g/cm <sup>3</sup> ]   |
| 22. Shelf-life time in days                |  |
| 23. Date                                   | [Product date (constant)]  |
| 24. VAT                                    | [VAT value related to a product]   |
| 25. Ingredients                            | [Field for inserting names of product's ingredients or for additional description regarding product's features, application, etc.]   |
| 26. Printout                               | [Template assigned to a product]   |

**CAUTION:** Remember to assign products to corresponding functions, as some of the data values are attributed according to their modes, e.g. thresholds in <Checkweighing> mode are set in [g], while thresholds in <Parts counting> mode are set in [pcs]. The values are selected automatically depending on which mode is enabled while entering a database.

## 16.4. Customers

Customers database contains name of Customers for whom the measurements are carried out.

### Procedure:

- Enter <Databases> submenu and press <Customers> entry.
- Press <Add> button.
- Select the already existing customer.

### List of parameters defined for a customer:

1. Customer name
2. Customer code [internal code identifying a customer]
3. TIN
4. Address
5. Postal code
6. City
7. Discount
8. Printout [type of printout, customer-related label]

## 16.5. Packaging

<Packaging> database contains a list of packages for which a name, code and mass value are specified. The tare value is automatically applied when a name of a packaging is selected from the database during weighing process. The tare value is displayed with minus sign.

### Procedure:

- Enter <Databases> submenu and press <Packaging> entry.
- Press <Add> button to add a new packaging, or
- Select the already existing one, and insert data on the packaging.

**Caution:** *It is possible to use 'search record' option; you can search by name or by code.*

## 16.6. Warehouses

Depending on the organization of work, the warehouses database contains a list of places used for picking up a sample for weighing or a list of places to which a weighed sample was delivered. Each warehouse has to have its name, code and description specified. During the weighing process, and upon selecting the name of a warehouse, it is automatically assigned to the measurement result.

### Procedure:

- Enter <Databases> submenu and press <Warehouses> entry.
- Press <Add> button to add a new warehouse, or
- Select the already existing warehouse.

**Caution:** *It is possible to use 'search record' option, you can search by name or by code.*

## 16.7. Printouts

Printouts database contains all NON-STANDARD printouts. Each printout features a name, code and a template.

### Procedure:

- Enter <Databases> submenu and press <Printouts> entry.
- Press <Add> button to add a new printout, or
- Select the already existing record.

**Caution:** *It is possible to use 'search record' option; you can search by name or by code.*

### Designing new printout template

### Procedure:

- Enter <Databases> submenu and press <Printouts> entry.
- Press <Add> button to create a new printout, or edit the already existing one.

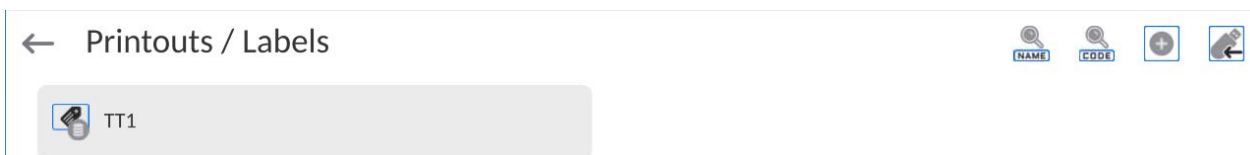

- Edit box opens, press <Project> entry.
- Respective box with an on-screen keyboard is displayed.
- To design a printout, you can use an external USB keyboard connected to the head or a touch keypad that has the same functions as a typical PC keyboard.

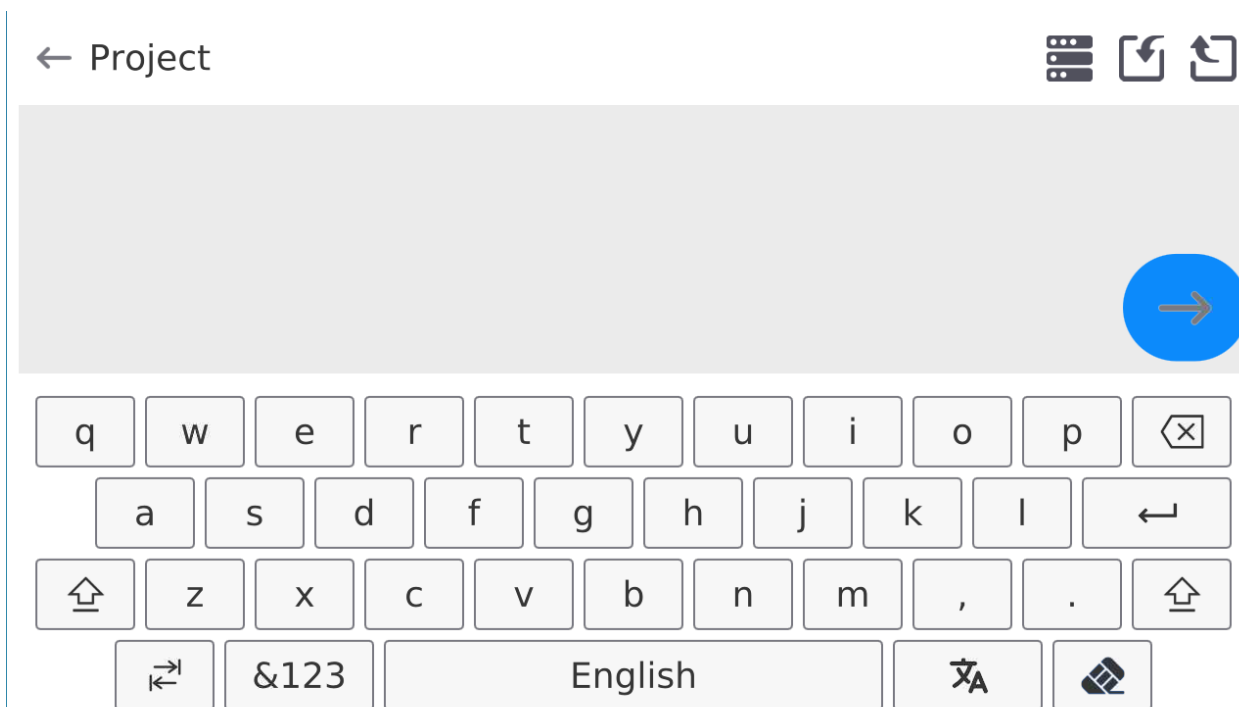

The touch keypad does not have some characters, such as a colon or diacritical letters typical of a specific menu language (menu language is signalled with description on 'SPACE' key). To use such characters or letters in the designed printout, press and hold the specific letter on the keyboard. It will cause additional keys with assigned characters to display. Click them to add to text. After entering the character, press 'X' to disable displayed characters.

The example of available characters for Polish keyboard.

Letter on the keyboard	Additional characters	Letter on the keyboard	Additional characters	Letter on the keyboard	Additional characters
„t”	€ ✕ t y	„u”	µ ✕ u i	„a”	~ ✕ a s
„x”	ı ` ✕ x c	„c”	\\   ✕ c v	„v”	[ { ✕ v b
„b”	] } ✕ b n i	„”	: < = ✕ , . ↵	„”	; > ✕ . ↵

- Save the designed printout.

### Example of Printout no. 1 – large edit box

← Project

BALANCE NO: {32}  
Max=220 g  
d={33}

PRODUCT: {50}  
DATE: {2}  
TIME: {3}

-----  
WORKING MODE: {5}

Project

Balance no. 400015  
Balance parameters:  
Max = 220 g  
d= 0.001 g

Product name:  
Date: 2011.10.24  
Time: 11:48:06

-----  
Working mode: Weighing  
-----  
Net weight: 94.147

Carried out by: Admin



Printout template



### Example of Printout no. 2 – printout from a file

All printout templates can be designed in a form of external files, that are imported to a balance; file extension: \*.txt or \*.lb. External file shall contain all constant and variable data. Upon importing, the content of a printout template can be modified.

#### Procedure:

- Design a \*.txt or \*.lb file in an optional editor.
- Copy the file to a USB flash drive.
- Connect the USB flash drive to the balance USB port.
- Press [4] <  Download a printout from a file> button,
- Balance display shows data stored on the USB flash drive connected to the USB port.
- Select file with a printout template and press its name.
- The printout template is automatically copied to an editing field.

	<b><i>The user may add printouts from external memory via import of already configured texts, using USB port.</i></b>
	<b><i>Printout name is not the content of a printout.</i></b>

	<b>List of variables intended for printouts is to be found in 'ANNEX 03'.</b>
	<b>Example of how to create and send label template to the balance memory is to be found in 'ANNEX 03'.</b>

## 16.8. Universal Variables

Universal Variables are alphanumeric data which can be combined with printouts, products or other comparison-related information. Each variable has to have its name, code and value specified.

### Procedure:

- Enter <Databases> submenu and press <Universal variables> entry.
- Press <Add> button to add new variable, or
- Select already existing universal variable, and modify the following fields: code, name, value.

**Caution:** It is possible to use 'search record' option; you can search by name or by code.

## 16.9. Databases Management

Function allowing to manage databases data. It comprises three options: Export weighing database, Delete databases and Delete weighings and reports.

← Manage the database

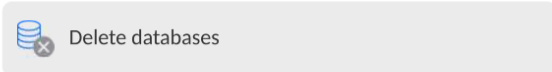

### 16.9.1. Delete Databases

Function allowing to delete data of selected database. Procedure  
 Activate <Delete database> function; a window with database list is displayed.  
 Select a database, delete respective data.

← Delete databases

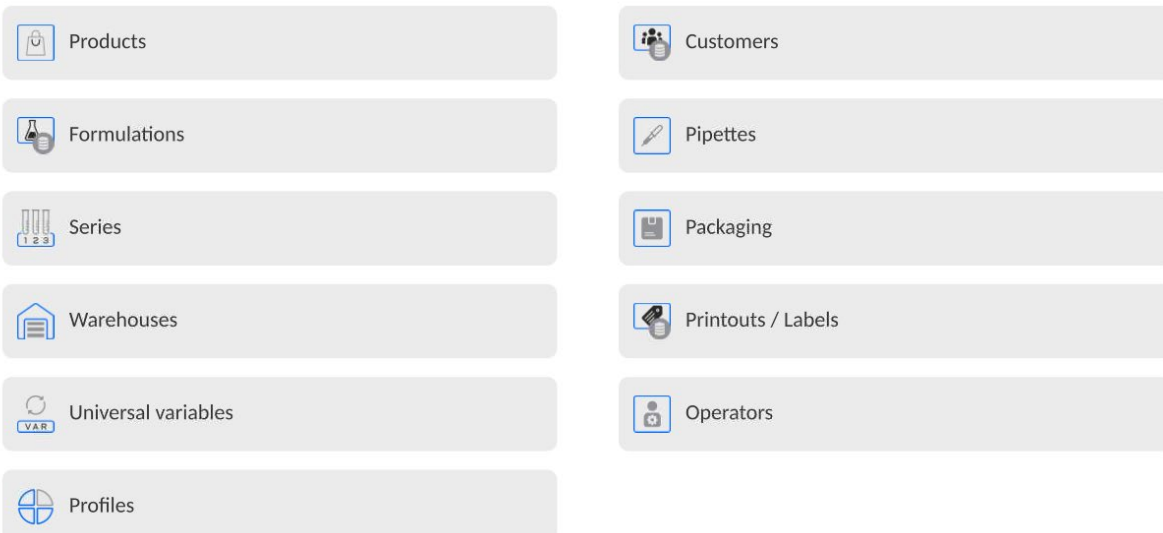

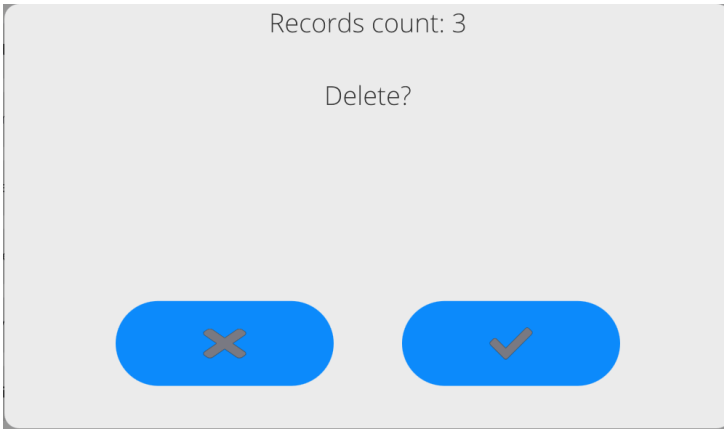

Confirm, data is deleted, the following message is displayed:

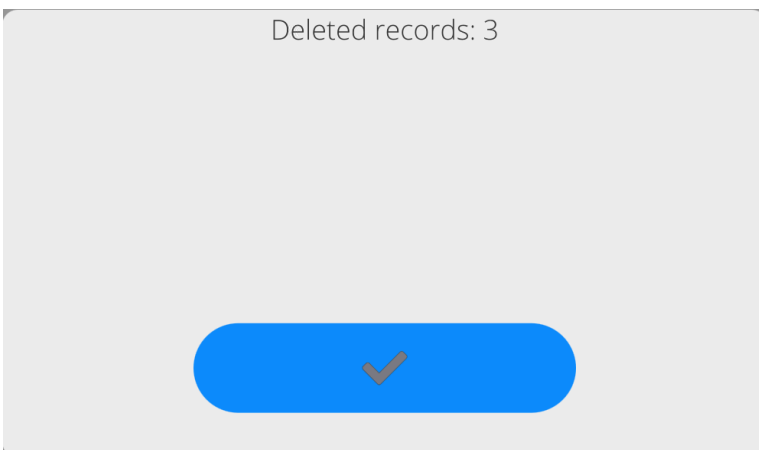

Confirm, a previous window is displayed; you may continue weighing or proceed to other operations.

## 17. REPORTS

The balance features the following reports:

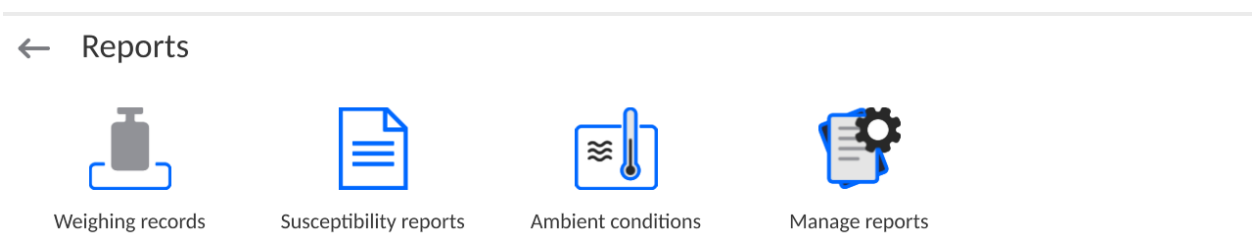

### 17.1. Reports Operations

**Reports can be operated** only by an authorized personnel.

Procedure:

- Press and hold a respective database pictogram.
- Database menu is displayed.
- Select one of the available entries (entries set is conditioned by a database).

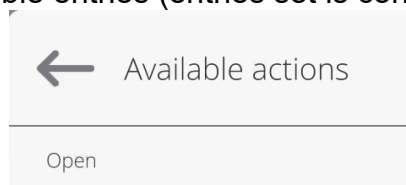

Entries:

- OPEN – select to enter a database (alternative method for database entering: single click on a given database field).

List of typical reports operations:

1. Searching for a record in a database by name.
2. Searching for a record in a database by code.
3. Searching for a record in a database by date.
4. Exporting database content to a USB flash drive via USB port.
5. Printing data on a specific record in a database.

The above processes are initiated by dedicated buttons located on the top of the display. Follow the displayed commands.

## 17.2. Weighings

Each weighing result sent from the weighing device to a printer is saved to the weighings database (read section *Result control*).

You can preview data of particular weighing records.

**Procedure:**

- Enter < **Reports** > submenu.
- Enter <**Weighings/Alibii**> database and select desired record.

**List of parameters defined for a weighing record:**

1. Measurement date.
2. Measurement result.
3. Tare value.
4. Stable/unstable measurement marking.
5. Air buoyancy control on/off marking.
6. Product name.
7. Operator.
8. Customer, customer name.
9. Working mode name.
10. Warehouse, source warehouse name.
11. Packaging, name of tare applied during product weighing.
12. Result control, information regarding range within which the weighed product is placed:
  - MIN – below LOW threshold (possible only if <Result control> is set to <NO> value),
  - OK – between the LOW and HIGH thresholds,
  - MAX – above HIGH threshold (possible only if <Result control> is set to <NO> value).
13. Weighing platform no., field with number of a weighing instrument by means of which a measurement was carried out.
14. Level status, information on level status maintained during the measurement .
15. Ambient conditions alerts, information regarding stability of temperature and humidity during the measurement.



### 17.3. Susceptibility: Reports

Susceptibility reports provide information about susceptibility determination. Each report can be previewed, searched by name, date, code or exported and printed out.

#### Procedure:

- Enter <Reports> submenu and press <Susceptibility: reports> entry.
- Select report, if not visible, scroll the list using navigation buttons.
- Report is named by date and time; e.g. 23.07.12 15:12:15.

#### CAUTION:

*It is possible to use 'search report' option.*

#### List of susceptibility reports data:

1. Start date
2. End date
3. Operator
4. Susceptibility
5. Susceptibility status
6. Polarization
7. Polarization status

### 17.4. Ambient Conditions

<Ambient conditions> database contains parameters related to ambient conditions. Depending on the balance type, the ambient conditions report can provide values of temperature, humidity, atmospheric pressure. If the given balance is connected to a THB sensor, then its indications are recorded to the database too.

#### Procedure:

- Enter < Reports > submenu and press <Ambient conditions> entry.
- Select report, if not visible, scroll using navigation buttons.
- Report is named by date and time.

**Caution:** *It is possible to use 'search report' option.*

### 17.5. Reports Management

Function allowing to manage databases data. It comprises three options: Export weighing database, Delete databases and Delete weighings and reports.

← Manage reports



Export weighing records database



Delete weighing records and reports



Global weighing count

13

### 17.5.1. Export Weighing Database to a File

All measurements are saved to the <Weighing records> database and can be exported to a file using a USB flash drive.

#### Procedure:

- Connect the USB flash drive to the USB port.
- Press <Export weighing records database to a file> entry; a window for setting export options is opened.

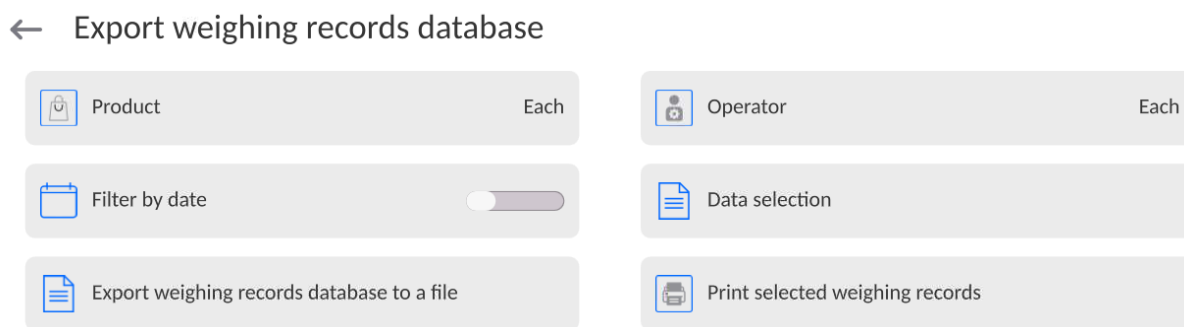

<Data selection> parameter allows you to specify which measurement-related data are to be exported.

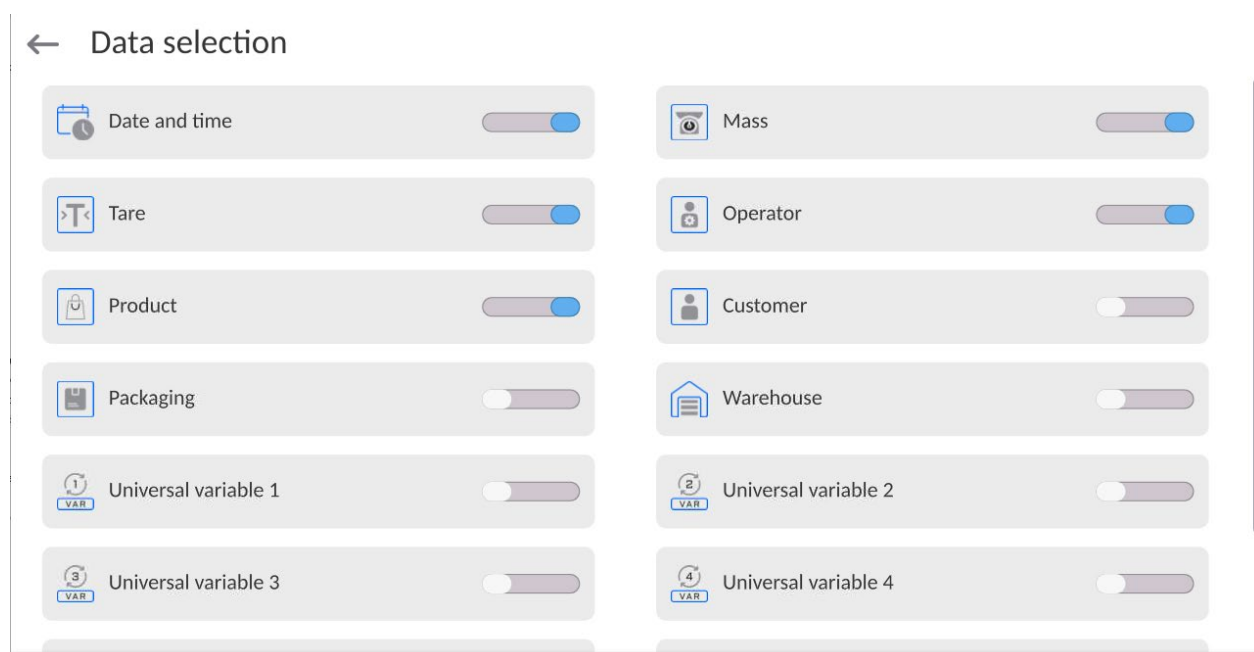

- Set respective data and press <Export weighing records database to a file> entry; weighing database is automatically exported.
- Upon export completion, the message <Completed> is displayed along with information on the number of exported data and with the file name (\*.txt extension).

Next, previous window is displayed.

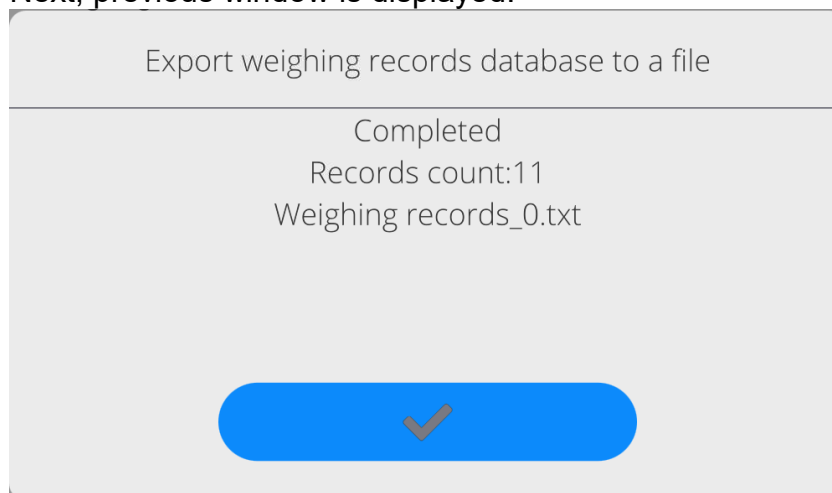

- You may return to the weighing procedure or proceed to other settings.

**Caution:** *If balance software cannot identify the USB flash drive, then upon pressing <Export weighings database to a file> entry, <Operation failed> message is displayed.*

- A name of created file consists of database name and balance serial number, e.g. <Weighing records\_0.txt>.
- Unplug the USB flash drive from the USB port.

#### **Template of a created file:**

The file is created in the form of a table, columns of which are separated by <Tab>. This allows for direct export of the file to <Excel> spreadsheet document. The table contains the following data: date and time, mass and mass unit, tare and tare unit, serial number, operator name, customer name, packaging name, source warehouse name, target warehouse name, control result name.

#### **17.5.2. Delete Weighings and Reports**

Function allowing to delete weighings and reports of a given database.

##### **Procedure:**

Activate <Delete weighing records and reports> parameter; a window with a numeric keyboard is displayed.

Enter a date specifying which data is to be removed. Date is given in the following form: year-month-day.

← Delete older than

16.03.2023

« <		marzec 2023					> »	
pon.	wt.	śr.	czw.	pt.	sob.	niedz.		
27	28	1	2	3	4	5		
6	7	8	9	10	11	12		
13	14	15	16	17	18	19		
20	21	22	23	24	25	26		
27	28	29	30	31	1	2		
3	4	5	6	7	8	9		



Confirm the date, all weighings and reports older than those specified by the date are removed. Quantity of deleted weighings and reports is displayed.

## 18. COMMUNICATION

Communication menu is located in the Parameters menu. To access Parameters menu, press Setup key or <Setup> quick access button. Communication between the balance and the peripheral devices is established via the following ports:

← Communication

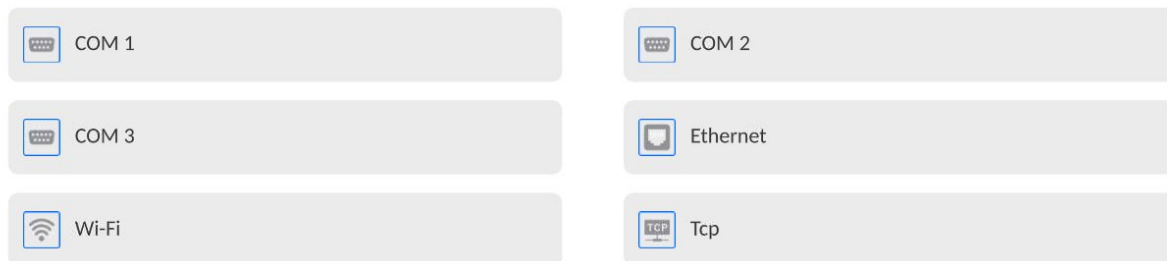

The parameters of each port can be configured depending on the needs.

It is possible to expand the range of interfaces with the use of the IM02 communication module that is connected to the scale via COM3 interface. In its standard design, the IM02 communication module is supplied with the following interfaces: RS 232 IM02, Virtual COM, 4WE/4WY.

### 18.1. RS232 Ports Settings

**CAUTION:** To ensure correct interaction with external devices via RS 232 ports, use a USB to RS232 converter.

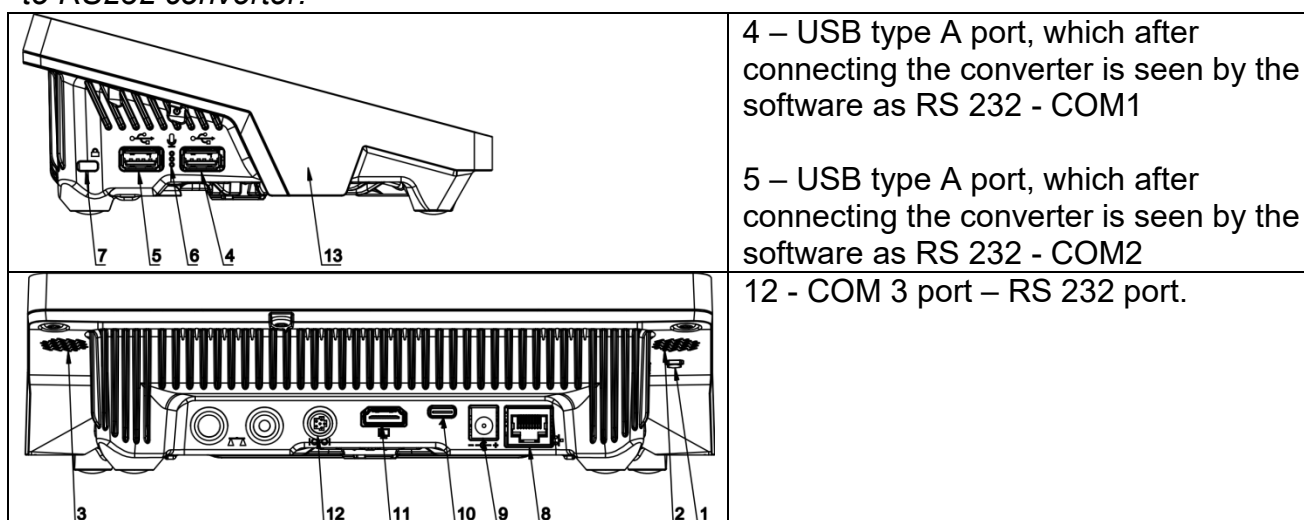

#### Procedure:

- Select communication port: <COM1>, <COM2> or <COM3>.
- Set respective parameters.

Transmission parameters for RS 232 ports:

- Baud rate: 4800, 9600, 19200, 38400, 57600, 115200 bit/s, 921600 bit/s\*
- Data bits: 5, 6, 7, 8
- Stop bits: None, 1, 1.5, 2
- Parity: None, Odd, Even, Marker, Space

\*) – Speed value available only to the COM3 port for cooperation with IM02 communication module.

## 18.2. ETHERNET Port Settings

### Procedure:

- Select <Ethernet> port. Set respective parameters:
  - DHCP: Yes – No
  - IP Address: 192.168.0.2
  - Subnet mask: 255.255.255.0
  - Default gate: 192.168.0.1

**Caution:** The above presented values serve informative purposes only. Set the transmission parameters in accordance with your local network.

Press  button, the message <Restart balance to implement changes> is displayed.

Return to the weighing procedure and restart the balance.

## 18.3. Wi-Fi Settings

A balance equipped with Wi-Fi displays a respective pictogram:

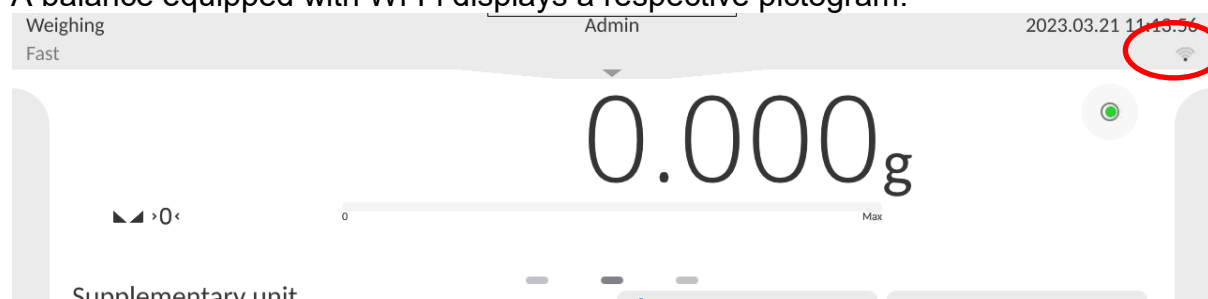

### Procedure:

- Select <Wi-Fi> communication interface. Set respective parameters:
  - DHCP: Yes – No
  - IP Address: 10.10.9.155
  - Subnet mask: 255.255.255.0
  - Default gate: 10.10.8.244

**Caution:** The above presented values serve informative purposes only. Set the transmission parameters in accordance with your local network.

Press  button, the message <Restart balance to implement changes> is displayed.

Return to the weighing procedure and restart the balance.

You may use <Available networks> parameter to view the list of networks detected by the balance:

← Available networks

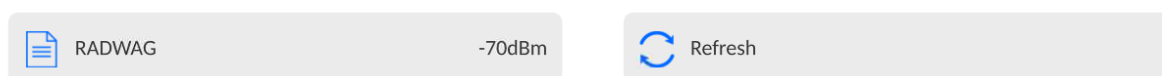

A pictogram with a padlock means that the password is required. Press <Refresh> to search for available networks.

Press <Network status> to check selected network parameters.

## ← Network status

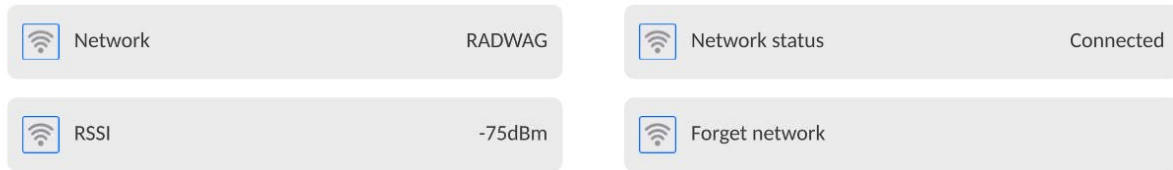

The selected network and connection parameters are saved to the balance memory. The program connects to the network in accordance with the memory-saved parameters each time the balance is switched on. To change this, select <Forget network> option. The previously selected network gets disconnected.

### 18.3.1. Hot Spot - General Information

Hot Spot - an open access point allowing wireless connection with the balance by another device - laptop, tablet or phone, using a wireless network based on Wi-Fi standard.

The owner of the Hot Spot decides for himself how, to whom and under what conditions he is going to make his link available by logging in, which requires having an individual user name and password (these data are given while starting the service and are stored in the memory of the balance).

### 18.3.2. Hot Spot Activation

#### 1. Enter Wi-Fi option

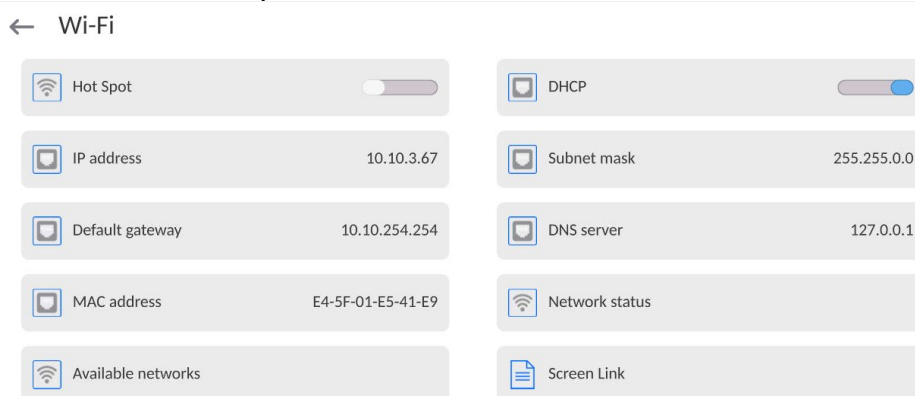

2. Activate Hot Spot, the balance will switch to the service settings after a moment.

Waiting for a service

Please wait

← Wi-Fi

<input checked="" type="checkbox"/> Hot Spot	<input type="checkbox"/> Name
<input type="checkbox"/> Password	<input type="checkbox"/> Link by QR code
<input type="checkbox"/> IP address	<input type="checkbox"/> Subnet mask
<input type="checkbox"/> Default gateway	<input type="checkbox"/> DNS server
<input type="checkbox"/> MAC address	<input type="checkbox"/> Screen Link

3. Enter an individual name and password for access (password must be at least 8 characters long).

← Name

ELIPSIS1234



q	w	e	r	t	y	u	i	o	p	⌫
a	s	d	f	g	h	j	k	l	↵	
⌄	z	x	c	v	b	n	m	,	.	⌆
↶	&123	English				⌘A	⌘			

Waiting for a service

Please wait

← New password

\*\*\*\*\*



q	w	e	r	t	y	u	i	o	p	⌫
a	s	d	f	g	h	j	k	l	↵	
⌄	z	x	c	v	b	n	m	,	.	⌆
⌘	↶	&123	English				⌘A	⌘		



← Repeat the new password

\*\*\*\*\*



Waiting for a service

Please wait

← Wi-Fi

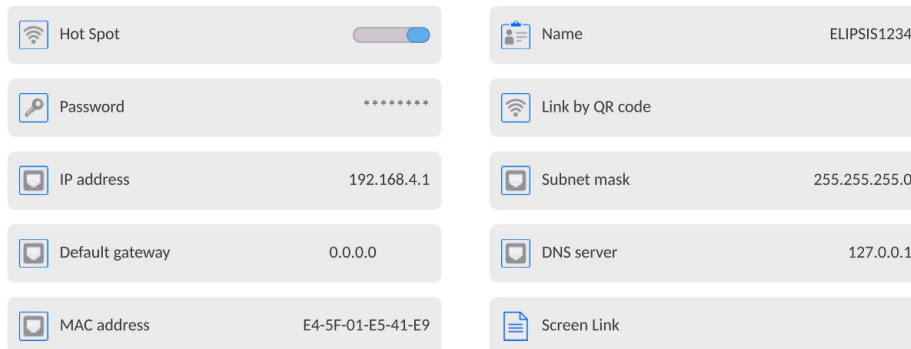

4. From now on, the Hot Spot service will be active and the created subnetwork will be visible by other smartphone devices under the name assigned above and you will be able to connect to it using the assigned password.

#### 18.4. TCP Settings

TCP (*Transmission Control Protocol*) is a stream protocol, operating in customer-server mode, enabling communication between two computers. TCP operates in client – server mode. You can establish a connection on the specified server port.

##### Procedure:

- Enter <Communication> parameters.
- Select <TCP / Port>; a <Port> window with an on-screen keyboard is opened.
- Insert required port number and press  button to confirm.

## 18.5. Virtual COM Settings

*Applicable in the case of an active IM02 communication module*

Virtual COM is intended for connecting the scale to a computer.

### Steps:

1. Enter **<Peripherals / Computer / Port>** submenu and set **Virtual COM** option.
2. Run a PC software to read measurements made with the scale.
3. Set communication parameters in the PC software, i.e.: COM port, transmission parameters.
4. Start connection.

## 19. PERIPHERALS

<Peripherals> menu is located in the <Parameters> menu. To access Peripherals menu, press Setup key or < Setup> quick access button. Peripherals menu provides a list of devices that can cooperate with the balance.

### 19.1. Computer

Active balance – computer connection is signalled by  pictogram (top bar of the home screen). Carry out configuration using <Computer> submenu.

#### Procedure:

- Press Setup and select <Peripherals/ Computer>.
- Set balance-computer operation parameters:
  - Computer port  
Available options: none, COM 1, COM 2, COM3, TCP, USB Free Link, RS 232 IM02\*\*, Virtual COM\*\*.

\*) - for port description, read section COMMUNICATION of the manual.

\*\* ) - Communication ports of the scale-connected IM02 communication module.

**USB FREE LINK** - USB type C port (socket no. 10 on the back of the indicator), to which the computer is connected using a USB type A/type C cable.

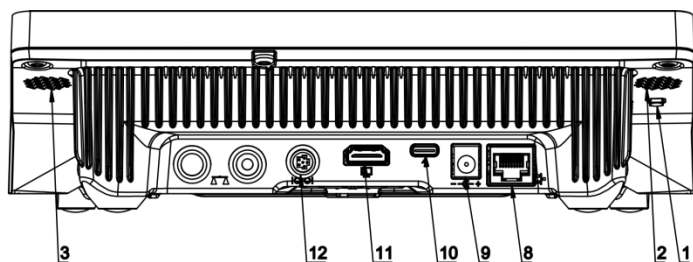

Tool for entering data, it functions as a keyboard. Upon proper modification of the standard or non-standard printout and sending a proper command from the computer, or upon pressing ENTER key located on the operation panel, the data from the non-standard printout are entered directly to computer programs, e.g. Excel, Word, Notepad etc. To ensure proper operation with Excel-type program, the non-standard printout must be properly configured by inserting the print formatting characters, such as Tab, Enter and language-specific diacritics, into the designed printout. Also remember to set the correct

decimal separator (full stop or comma) that the Excel-type program will accept. It can be set in: *Setup/Misc./Decimal point*.

Below is an example of a printout template and the resulting printout in Excel:

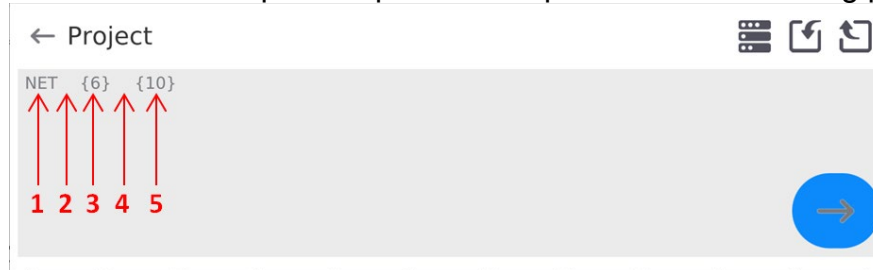

- 1 – fixed text
- 2 – tab key (skip to the next column)
- 3 – variable {6}, net weight in an adjustment unit
- 4 – tab key (skip to the next column)
- 5 – variable {10}, mass unit

	A	B	C	D	E	F	G
1							
2							
3				NETTO:	1,1235 g		
4				NETTO:	1,1455 g		
5				NETTO:	1,1258 g		
6				NETTO:	1,1325 g		

### 19.1.1. Computer address

Setting a balance address which computer is connected to.



#### Procedure:

- Enter **<Devices / Computer / Address>** submenu and you will see **<Address>** box with on-screen keyboard.
- Enter address and press  to confirm changes.

### 19.1.2. Permanent transmission

Activation of balance-computer permanent transmission. After enabling **<Permanent transmission>** parameter, the content of **<Weighing Printout Template>** is continuously sent to the PC.

#### Procedure:

- Enter **<Devices / Computer / Permanent transmission>** submenu and set relevant value ( - Permanent transmission disabled;  - Permanent transmission enabled).

### 19.1.3. Interval

Setting frequency of **<Weighing Printout Template>** printout for permanent transmission. Printing frequency can be set in seconds, with an accuracy of 0.1sec. and the range from 0.1 to 1000 seconds.

#### Procedure:

- Enter **<Devices / Computer / Interval>** submenu and you will see **<Interval>** edition window.
- Enter desired value and confirm by pressing .

### 19.1.4. Weighing printout template

A unique template for printing from balance to PC.

#### Procedure:

- Enter **<Devices / Computer / Weighing Printout Template>** submenu. You will see **<Weighing Printout Template>** window with an on-screen keyboard.
- Modify the template and confirm changes by pressing .





### 19.1.5. Cooperation with E2R System

Activation of cooperation between the balance and **E2R System**. **E2R System** software is a modular system that comprehensively supports production processes related to weighing at various stages.

	<b><i>Only &lt;Administrator&gt; is allowed to activate &lt;E2R&gt; parameter. In case of cooperating with the &lt;E2R System&gt; software, database edition in the balance is blocked.</i></b>
---	---

Access path:  / **<Devices / Computer / E2R System>**.

#### List of options in **<E2R System>** submenu:

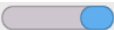
<b>Active system</b>	Activation of connection to <b>E2R System</b> :  - connection disabled,  - connection enabled. If the connection is enabled, the  icon in the top bar of the home screen will be visible.
<b>Block product selection</b>	Activation of product selection lock for balance operator:  - lock disabled,  - lock enabled.
<b>Databases</b>	Submenu with configuration of databases that cooperate with E2R System.
<b>Info</b>	List of database events that occur during active connection to E2R System.

## 19.2. Printer

<Printer> submenu allows you to:

- set port for establishing communication with a printer: COM 1, COM 2, COM3, USB, Tcp Client, USB Free Link\*, RS 232 IM02\*\*;
- define printer's code page (default: 1250),
- define control codes for PCL printer or receipt printer.

**Caution: Codes must be entered in a hexadecimal form!**

- define printout templates.

\*) - for port description, read section COMMUNICATION of the manual.

\*\* ) - Communication ports of the scale-connected IM02 communication module.



To ensure correct balance – printer operation (correct printout of diacritical signs of a given language), respective baud rate, obligatory for a given printer, must be chosen (see the printer settings). Additionally, the code page of a sent printout must be accordant with the code page of a printer.

There are two methods for obtaining code page accordance:

- by setting the right code page in printer settings (read the printer manual) – respective to the printout code page set in the balance;

Code page	Language
1250	Polish, Czech, Hungarian.
1252	English, German, Spanish, French, Italian.
1254	Turkish.

- by sending a control code from the balance to the printer, which automatically sets the right code page (respective to the code page set in the balance) before the data printout – it is possible only for printers equipped with this option.

	<b>Default value of printer code page is 1250 – central European code page.</b>
	<b>Detailed description of communication between the balance and the labeller is to be found in 'ANNEX 03'.</b>

**USB FREE LINK** - USB type C port (socket no. 10 on the back of the indicator), to which the computer is connected using a USB type A/type C cable.

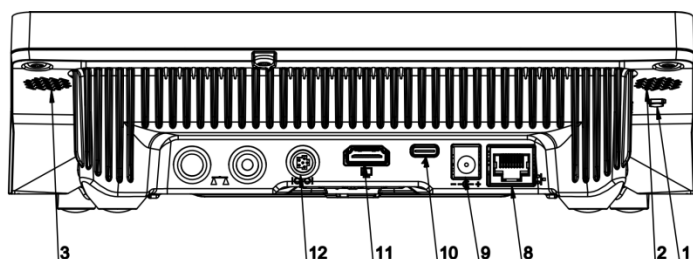

Tool for entering data, it functions as a keyboard. Upon proper modification of the standard or non-standard printout and sending a proper command from the computer, or upon pressing ENTER key located on the operation panel, the data from the non-standard printout are entered directly to computer programs, e.g. Excel, Word, Notepad etc. To ensure proper operation with Excel-type program, the non-standard printout must be properly configured by inserting the print formatting characters, such as Tab, Enter and

language-specific diacritics, into the designed printout. Also remember to set the correct decimal separator (full stop or comma) that the Excel-type program will accept. It can be set in: *Setup/Misc./Decimal point*.

Below is an example of a printout template and the resulting printout in Excel:

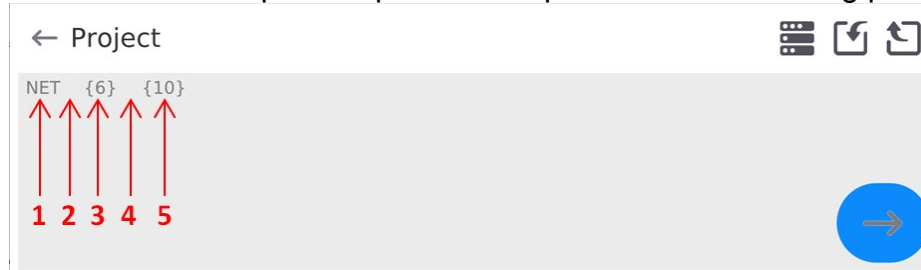

- 1 – fixed text
- 2 – tab key (skip to the next column)
- 3 – variable {6}, net weight in an adjustment unit
- 4 – tab key (skip to the next column)
- 5 – variable {10}, mass unit

	A	B	C	D	E	F	G
1							
2							
3				NETTO:	1,1235 g		
4				NETTO:	1,1455 g		
5				NETTO:	1,1258 g		
6				NETTO:	1,1325 g		

If data with a high information content, such as the SQC report, is to be printed using Free Link, it is imperative that the parameter <Receipt printer speed [character/second]> is set to 15.

← Printer

Port	COM 1	Code page	1250
Control codes		Receipt printer speed [character/second]	0
Printouts			

A printout template describes how to print information from databases.

The template can be modified. In order to check the format of a printout template, print the data related to e.g. product parameters. To do it, go to <Products/Edit product> submenu and press printer pictogram.

Default values for particular templates:

Product printout template	{50}
	{51}
Operator printout template	{75}
	{76}
Customer printout template	{85}
	{86}
Warehouse printout template	{130}
	{131}

```

Package printout template      {80}
                               {81}
                               {82}
Ambient conditions printout template
----- AMBIENT CONDITIONS-----
                               {275}
                               IS T1: {278} °C
                               IS T2: {279} °C
                               THB T: {276} °C
                               THB H: {277} %
-----

```

### 19.3. Barcode Scanner

The balance enables operation with a barcode scanner. The barcode scanner is used to facilitate quick search for database records:

- Products,
- Operators,
- Customers,
- Packages,
- Warehouses,
- Formulations,
- Pipettes,
- Series in a differential weighing,
- Universal variables.

	<p><b><i>In &lt;Communication&gt; submenu it is necessary to set baud rate value to a value accordant with bar code scanner (by default 9600b/s). Detailed description of communication between the balance and the bar code scanner is to be found in 'ANNEX 03'.</i></b></p>
---	--

To configure the barcode scanner, enter:  
**„Setup / Peripherals/ Barcode scanner”**.

#### 19.3.1. Barcode Scanner Port

##### Procedure:

- Enter **<Peripherals>** parameter and go to **„Barcode scanner / Port”** parameter. Select respective option.

Ports for balance - scanner communication:



- RS 232 (COM1),
- RS 232 (COM2),
- USB

### 19.3.2. Prefix/Suffix

You can edit <Prefix> and <Suffix> to synchronize the balance program with the barcode scanner.

**Caution:** In RADWAG-adopted standard, the prefix is 01 sign (byte) hexadecimal format, the suffix is 0D sign (byte) hexadecimal format. For detailed description of the balance - barcode scanner communication, read **ANNEX 03**.

#### Procedure:

- Enter <Barcode scanner> submenu,
- Select <Prefix> parameter and enter hexadecimal value using the on-screen keyboard. Press  button to confirm.
- Select <Suffix> parameter and enter hexadecimal value using the on-screen keyboard. Press  button to confirm.

### 19.3.3.Field Selection

Parameter for specifying for which field the search is to be carried out in particular databases.

#### Procedure:

- Enter < Peripherals> submenu,
- Select „Barcode scanner / Field selection”. List of fields is displayed:

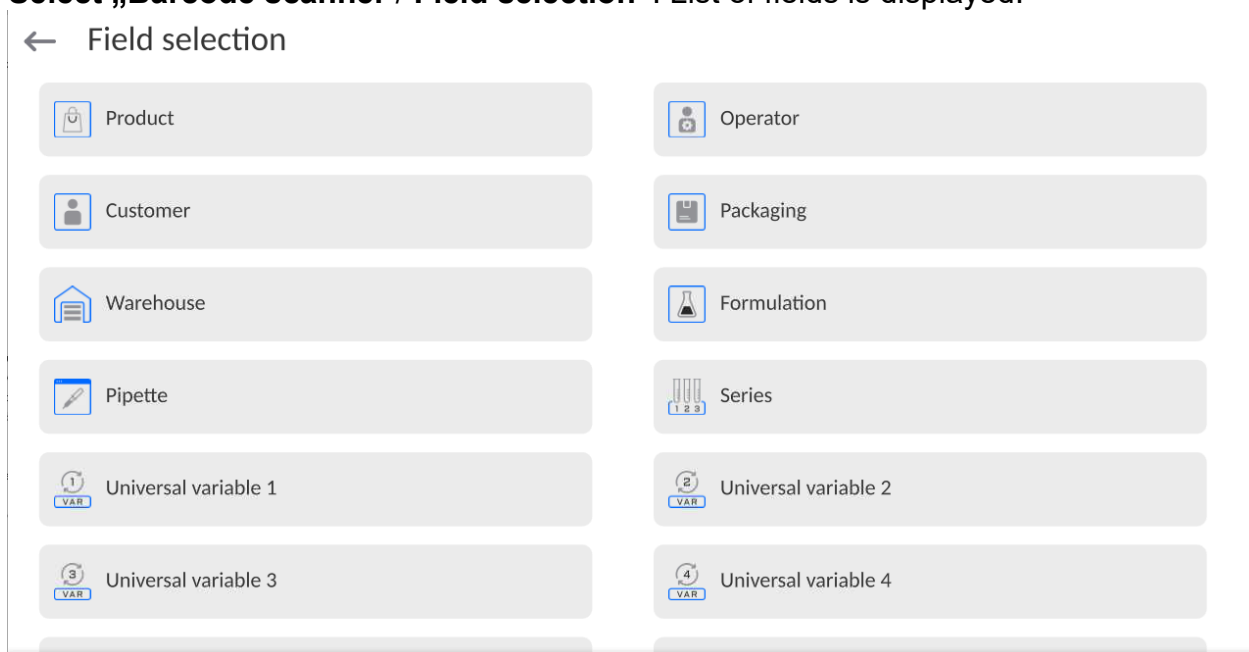

- Select one item from the list. The following parameters may be edited:

<b>Filtering</b>	Parameter allowing you to declare search criteria (see table below)
<b>Offset</b>	Parameter allowing you to set the first significant code's character; characters preceding the first significant character are skipped during comparison search.
<b>Code length</b>	Parameter allowing you to set the number of code's characters to be taken into account during search procedure.
<b>Start marker</b>	Parameter allowing you to declare the starting point of scanned code, taken into account during the search.



<b>End marker</b>	Parameter allowing you to declare the ending point of scanned code, taken into account during the search.
<b>Ignore marker</b>	Parameter allowing you to determine whether start and end markers are to be referred to or skipped during comparison of a scanned code with the code saved to the balance.

#### Filtering criteria conditioned by field type:

Field selection	Filtering
Product	None, Name, Code, EAN code
Operator	None, Name, Code,
Customer	None, Name, Code,
Packaging	None, Name, Code,
Warehouse	None, Name, Code,
Formulation	None, Name, Code,
Pipette	None, Name, Code,
Series	None, Name, Code,
Universal variables	None, Active

#### 19.3.4.Test

**<Test>** parameter allowing you to verify if operation of a barcode scanner connected to a balance is correct.

#### Procedure:

- Enter **<Barcode scanner>** submenu,
- Select **<Test>** parameter; **<Test>** edit box is displayed, it features ASCII and HEX fields.
- The code is scanned and entered to the ASCII and HEX fields; next, the test result is displayed in the bottom part.

#### When:

- **<Prefix>** and **<Suffix>** declared in the balance settings comply with **<Prefix>** and **<Suffix>** of the scanned code, the test result is **<Positive>**,
- **<Prefix>** and **<Suffix>** declared in the balance settings do not comply with **<Prefix>** and **<Suffix>** of the scanned code, the test result is **<Negative>**,

### 19.4. Ambient Conditions Module

Ambient conditions module (THB) can be connected to the balance via COM 1, COM 2, UDP or USB ports. In order to provide correct cooperation, enter the module address and baud rate for the port (port settings) to which the ambient conditions module is connected (the address and baud rate are to be found on the module's data plate).

## 19.5. IM02 communication module

The IM02 communication module allows the scale to cooperate with such accessories as printers, control keys, stack lights, buzzers, PLC controllers, as well as other control-signalling devices and PCs.



***The procedure of connecting the IM02 communication module to the supply network and scale has been described in detail in the 'IM02 communication module' manual.***

### 19.5.1. Activation of IM02-to-scale connection

- Connect the IM02 communication module to the COM3 port of the scale.
- Connect the IM02 communication module to the supply network.
- Enter **<Peripherals / IM02 communication module / Active>** submenu and enable IM02 communication module ( - module active,  - module inactive).
- Once the IM02 communication module has connected to the scale, the following information will be automatically displayed:

<b>Status</b>	Active connection status, the status takes the following values: Connected, Not connected.
<b>Software rev.</b>	Software version of the IM02 communication module.
<b>Manufacture variant</b>	IM02 communication module manufacture version.

- Simultaneously the scale menu is extended to include **<Inputs / Outputs>** submenu and list of available communication ports in the **<Communication>** submenu.

## 19.6. Automatic Feeder

*(function disabled for standard balance models).*

Communication between the balance and the automatic feeder can be established via the following ports:

- RS 232 (COM1)
- RS 232 (COM2)
- Com internal.

To ensure correct cooperation with the feeder, set its address (the address and baud rate are to be found on the automatic feeder's data plate).

## 20. INPUTS/OUTPUTS

*Applicable in the case of an active IM02 communication module*

The PUE CY10 meter can support **4 inputs / 4 outputs** via connection to the IM02 communication module.

Access path: < / Inputs/Outputs>.

### 20.1. Input Setup

- Enter <Inputs/Outputs> submenu.
- Select <Inputs> parameter, list of available inputs is displayed.
- Edit selected input, list of functions to be assigned is displayed. Input functions list is identical like key functions list.
- Select the function you want to assign to the input, next go back to the home screen.



***By default all functions are assigned with <None> value.***

### 20.2. Output Setup

Output gets activated at the moment of assigning it with a given function. Unassigned outputs remain inactive.

#### Procedure:

- Enter <Inputs/Outputs> submenu.
- Select <Outputs> parameter, list of available outputs is displayed.
- Edit selected output, list of functions to be assigned is displayed.

<b>None</b>	Output inactive.
<b>Stable</b>	Stable weighing result over LO threshold value.
<b>MIN stable</b>	Stable weighing result below the MIN threshold.
<b>MIN unstable</b>	Unstable weighing result below the MIN threshold.
<b>OK stable</b>	Stable weighing result between MIN and MAX thresholds.
<b>OK unstable</b>	Unstable weighing result between MIN and MAX thresholds.
<b>MAX stable</b>	Stable weighing result over the MAX threshold.
<b>MAX unstable</b>	Unstable weighing result over the MAX threshold.
<b>! OK stable</b>	Stable weighing result out of OK threshold.
<b>! OK unstable</b>	Unstable weighing result out of OK threshold.
<b>MIN</b>	MIN threshold signalling.
<b>OK</b>	OK threshold signalling.
<b>MAX</b>	MAX threshold signalling.
<b>! OK</b>	Signalling of weighing result out of OK threshold.
<b>Zero</b>	Zero weighing result („zero” marker).

- Select the function you want to assign to the output, next go back to the home screen.



***By default all functions are assigned with <None> value.***

## 21. MISCELLANEOUS PARAMETERS

This menu contains parameters facilitating balance operation language, date – time, beep sound, display adjustment, level control. To enter <Misc.> submenu, press Setup and next press <Misc.> button.

### 21.1. Interface Language

#### Procedure:

Enter <Misc.> submenu.

Select <Language> parameter and set language.

Available languages: Polish, English, German, French, Spanish, Korean, Turkish, Chinese, Italian, Czech, Romanian, Hungarian, Russian, Serbian.

### 21.2. Date and Time

You can set date, time and their formats.

There are two ways to edit date and time settings:

- Press <Date and time> entry (home screen's top bar).
- Go to <Setup / Misc./ Date and time>.

Enter the date and time settings; an on-screen keyboard is displayed. Set date and time: year, month, day, hour, minute; confirm the changes.

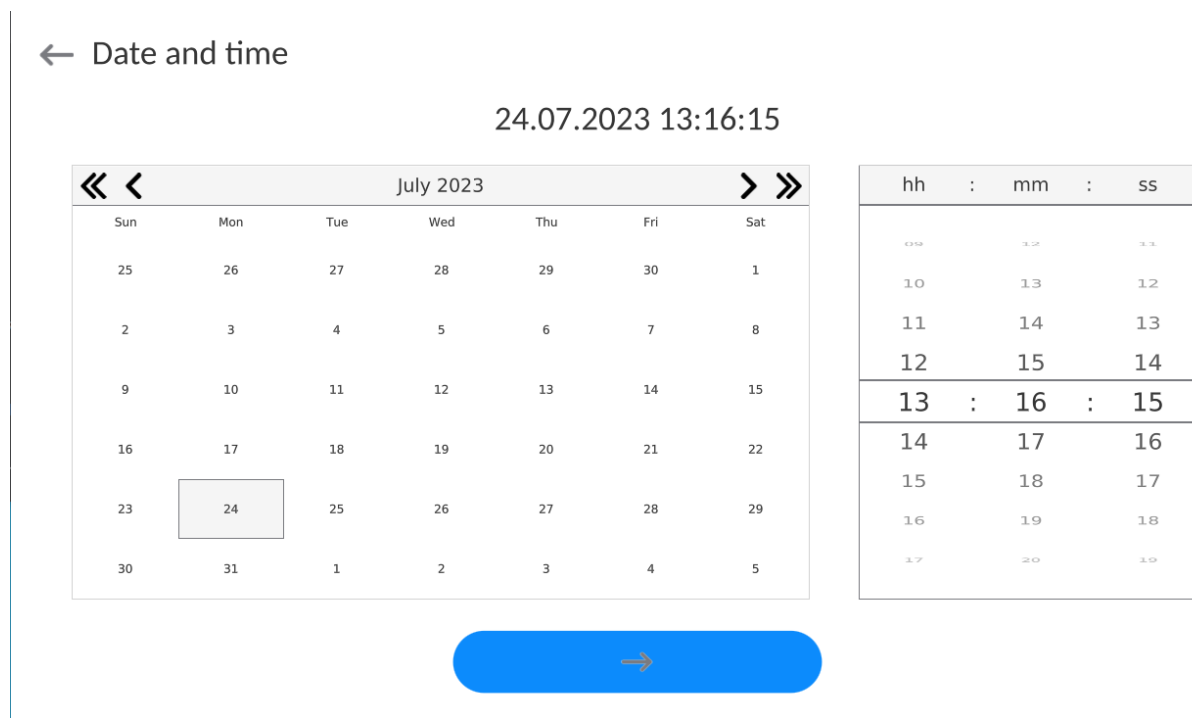

Additional functions of <Setup / Misc./ Date and time> submenu:

Name	Value	Description
Time zone	Europe, Warsaw	Parameter value: name of time zone/country. Particular name contains information regarding summer/winter time change.
Date and time	2016.04.04 08:00:00	Enter this parameter to set an internal clock and date.

Date format	yyyy.MM.dd *	Enter this parameter to select date format. Options: d.M.yy, d/M/yy, d.M.yyyy, dd.MM.yy, dd/MM/yy, dd-MM-yy, dd.MM.yyyy, dd/MM/yyyy, dd-MMM-yy, dd.MMM.yyyy, M/d/yy, M/d/yyyy, MM/dd/yy, MM/dd/yyyy, yy-M-dd, yy/MM/dd, yy-MM-dd, yyyy-M-dd, yyyy.MM.dd, yyyy-MM-dd.
Time format	HH:mm:ss **	Enter this parameter to select time format. Options: H.mm.ss, H:mm:ss, H-mm-ss, HH.mm.ss, HH:mm:ss, HH-mm-ss, H.mm.ss tt, H:mm:ss tt, H-mm-ss tt, HH.mm.ss tt, HH:mm:ss tt, HH-mm-ss tt, h.mm.ss tt, h:mm:ss tt, h-mm-ss tt, hh.mm.ss tt, hh:mm:ss tt, hh-mm-ss tt
Hide time	No	Enabling/disabling date and time preview on the home screen.
Time from the Internet	Yes	Enter this parameter to update time and date of a network-connected balance with the network time and date.
Synchronized with the Internet	Yes	Parameter informing whether time and date values have been synchronized with the network data.

\*) - For date format: y – year, M – month, d – day

\*\*) - For time format: H – hour, m – minute, s – second

<Date and time> parameter enables preview of declared date and time formats.

← Date and time

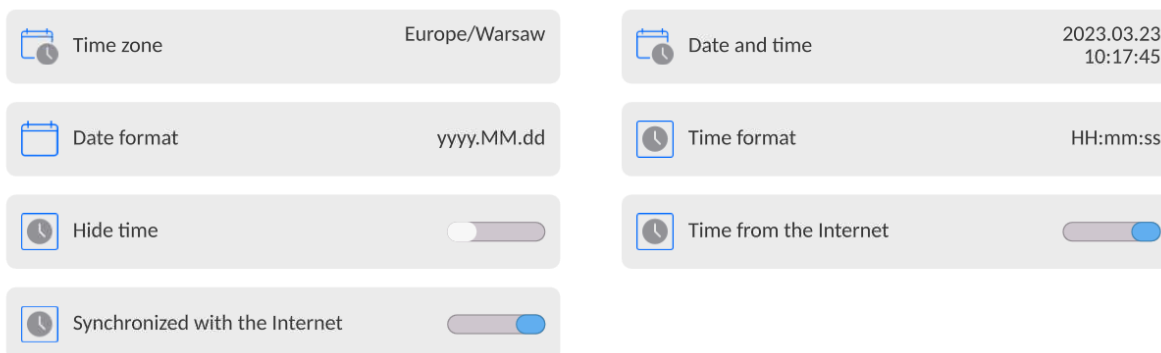

**Caution:** <Date and time> parameter can be accessed only by an operator with appropriate permissions. Permissions level can be modified by the administrator in <Permissions> menu.

### 21.3. Extension Module

Extension module allows to:

- activate compliance with FDA 21 CFR procedures,
- run communication protocol extension, and
- disable standard licence (demo balance mode).

In order to run the mode, a license number is required for a particular option release. You must contact the manufacturer if you want to get the number.

#### Procedure:

Enter <Misc.> submenu, select <Extension modules> parameter and follow the prompts.

## 21.4. Sound

### Procedure:

Enter <Misc.> submenu, select <Sound> parameter and set appropriate option:

Printout confirmation sound	– Yes/No
Touch panel sound	– Yes/No
Sensors	– Yes/No
Button	– Yes/No
Volume	– range 0 - 100%

## 21.5. Visual printout cofirmation

The option that allows you to visually confirm the measurement and record it in the weighing record base. After entering < value, every saved measurement will be communicated to the operator through temporary illumination of the mass display in blue.



## 21.6. Sleep Mode

You can turn on display sleep mode.

Procedure:

Press Setup key, next press: < Misc./Display sleep mode> submenu.

Select one of the following options: [None; 1; 2; 3; 5; 10; 15]. Digits stand for minutes. The software returns to the previous menu.

### **CAUTION:**

*The display turns to sleep mode only when the balance is not operated (the indication on the screen remains the same). Upon mass change, or pressing any key on the panel, the balance returns to weighing.*

## 21.7. Display Brightness

Display brightness influences the duration of operation of battery-powered balance. The brighter the screen, the shorter the operation time. To make the balance work longer, reduce screen brightness.

Procedure:

Press Setup, next press: <Misc./Display brightness> submenu.

Enter desired value: [0% - 100%]. Display brightness changes automatically, the previous menu is displayed.

## 21.8. Vibration Detection

The program detects incorrect loading of the weighing pan with the sample. Incorrect loading can lead to increased indication errors. Activation of 'Vibration detection' function is signalled with display of a respective pictogram in the weighing result window.

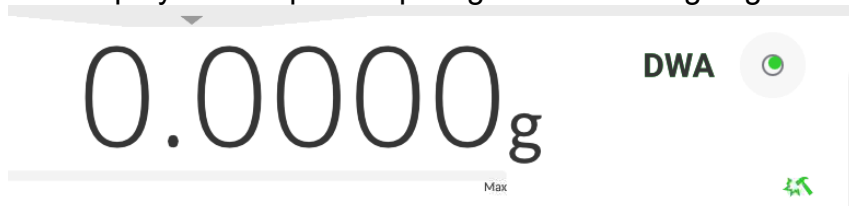

If incorrectly carried out loading is detected, the pictogram turns to red . The measurement result may be affected by a greater error.

### Procedure:

- Enter <Misc.> submenu.
- Select <Vibrations detection> parameter.
- Select one of available options:
  - Yes – function on / No – function off

## 21.9. Level Control

The balance is equipped with Automatic Level Control mechanism.

You can define its operation for non-verified devices.

In the case of verified instruments, the settings are hidden and the balance operates in accordance with factory settings, i.e. <Active with lock>. The weighing process is possible only if the balance is properly levelled.

### Procedure:

- Enter <Misc.> submenu.
- Select <Level control> parameter, an edit box is displayed.
- Select one of available options:
  - None – level indicator not displayed, the balance does not control level status,
  - Active – level indicator displayed, level status is signalled by colour (green→ level status OK, red→ levelling required).
  - Active with lock – level indicator displayed, level status is signalled by colour (green→ level status OK, red → levelling required). For red level indicator 'no Level' alert is displayed - weighing function is blocked.

**Caution:** For detailed information on levelling, read section 13.3 of this user manual.

## 21.10. Decimal Point

Parameter allowing to set punctuation mark for a printout.

### Procedure:

- Enter <Misc.> submenu.
- Select <Decimal point> parameter, an edit box is displayed.
- Select one of available options:
  - Dot
  - Coma

Submenu screen is displayed.

## 21.11. Proximity Sensors Sensitivity

Parameter allowing you to change sensitivity of the proximity sensors; the values range between 0 - 9.

By default, it is 5 - 7.

### Procedure:

- Enter <Misc.> submenu.
- Select <Proximity sensors sensitivity> parameter, an edit box is displayed.
- Select one of available options. Menu screen is displayed.

## 21.12. Doorway Degree

Parameter for setting how wide the door is to be opened in the case of an automatic operation.

Default value: <100 %> - maximally wide open door.

### Procedure:

- Enter <Misc.> submenu.
- Select <Doorway degree> parameter, an edit box is displayed.
- Set <75%> value.
- Confirm. Menu is displayed.

## 21.13. Automatic Ionization

Parameter for switching the ionization on and setting the ionization state.

Options: None/Low/High.

### Procedure:

- Enter <Misc.> submenu.
- Select <Automatic ionization> parameter, settings window is displayed.
- Set <Low> value.
- Confirm. Menu is displayed.

## 21.14. Autotest

<AUTOTEST> function has been designed to help you assess balance operation and to diagnose the cause of weighing errors (exceeding the maximum permissible values). AUTOTEST facilitates systematic optimisation of balance settings, which is necessary to maintain the best possible repeatability and weighing time at the workstation. The function allows you to monitor the parameters at an optional moment and save records from carried out tests.

There are two modules:

AUTOTEST FILTER; AUTOTEST GLP.

Prior to each test, the balance controls level status, temperature and humidity.

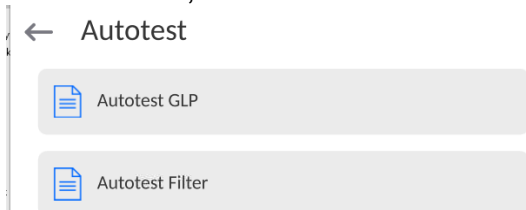



## AUTOTEST FILTER

Procedure consisting in loading and unloading of the internal weight for all possible 'Filter' and 'Value release' settings; the test requires 10 repetitions. It controls 2 parameters: 'Repeatability' and 'Stabilization time'.

The test takes approximately 1 hour. Upon completion, information regarding results is obtained.

Optimal settings for particular ambient conditions are provided.

Autotest Filter enables:

- to obtain the highest measurement repeatability and the shortest measurement time with acceptable value of repeatability;
- test results are stored in the balance memory until it is turned off,
- test results printout,
  - direct and fast selection of optimal parameters.

Upon completed autotest, a summary with the results is displayed.

Information regarding filter settings is provided automatically via respective pictograms:

- settings providing the fastest measurement (the shortest measurement time).
- settings providing the most accurate measurement (the lowest possible value of deviation for 10 measurements).
- settings providing optimal measurement (the lowest value of time and deviation product).

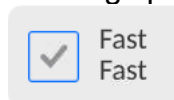

- current settings for filters.

Measurement results:

- \*Filter type.
- \*<Value release> parameter value.
- \*Repeatability of indications expressed as standard deviation.
- \*Average time of measurement stabilization.

*Example:*

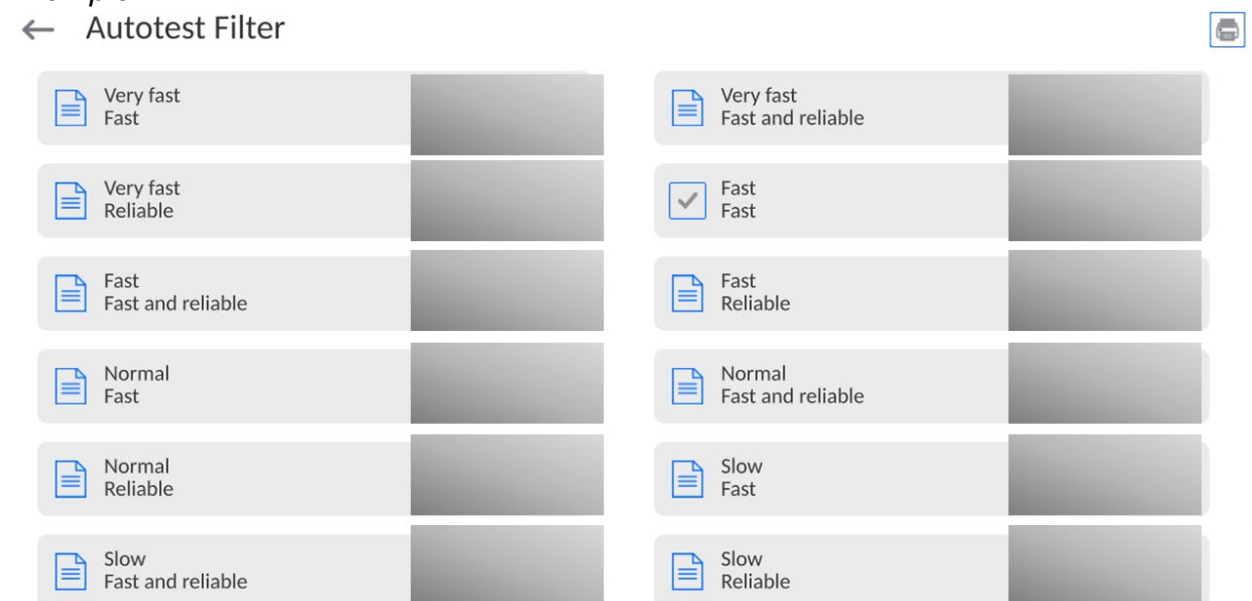

## Report example:

----- Autotest Filter: Report -----

Balance type	XA 5Y
Balance S/N	442566
Operator	Hubert
Software ver.	NL1.6.5 S
Date	2015.05.07
Time	09:34:48

-----

Reading unit	0.0001/0.0001 g
Internal weight mass	148.9390 g
Temperature: Start	25.26 °C
Temperature: Stop	25.66 °C

-----

Filter	Very fast
Value release	Fast
Repeatability	0.0042 g
Stabilization time	4.505 s

Filter	Very slow
Value release	Reliable
Repeatability	0.0207 g
Stabilization time	5.015 s

Signature  
.....

## Procedure:

Upon 'Autotest Filter' function activation, the process starts automatically. A progress bar is displayed. Upon process completion, a summary is displayed and the current filter settings are provided. The report can be printed.

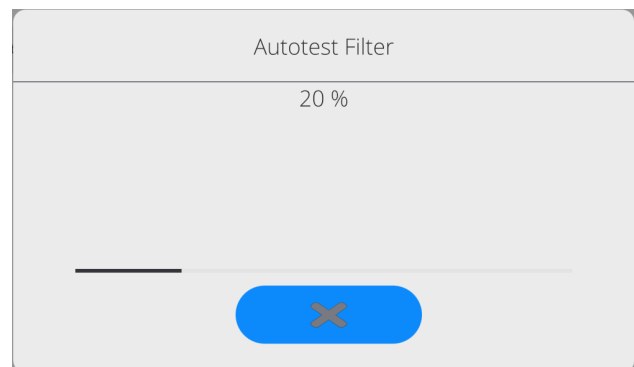
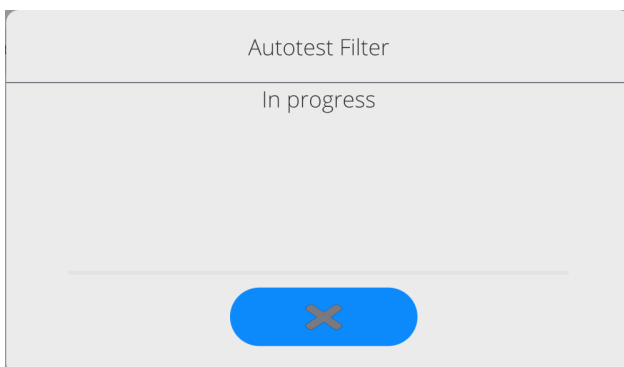

You can abort the process at any moment. To do that, press <  > button.

## AUTOTEST GLP

Autotest GLP is a test of repeatability of internal weight loading and determination of indication error, which error is referred to the balance maximum capacity.

## Procedure:

- load the internal weight twice, next load the internal weight ten times,

- adjust the balance,
- calculate and record the value of standard deviation.
- for a balance with automatic door, the door opening and closing test is carried out.

Autotest GLP function enables:

Report display and printout,

Record of a report containing basic data, ambient condition values and test results.

Test results:

\*Deviation for maximum capacity.

\*Value of repeatability expressed as standard deviation.

\*Door test result (positive / negative).

### Report example:

```

.....
----- Autotest GLP: Report -----
Balance type      XA 5Y
Balance S/N      400010
Operator         Admin
Software ver.    NLx.x S
Date             2012.01.16
Time            09:17:16
-----
Measurements quantity  10
Reading unit          0.0001 g
Internal weight mass  140.094 g
Filter               Average
Value release        Fast and precise
-----
Deviation for Max.    -0.0118 g
Repeatability        0.00088 g
Signature
.....

```

### Procedure:

Press entry with the test name, a message box is displayed.

Do one of the following:

- Start subsequent AUTOTEST GLP process,
- Preview results of completed autotests, and export all saved test results as a \*.csv file,
- Delete all saved test results.

You can abort the process at any moment by pressing <X> button.

Results of carried out autotests are displayed in a table (each line features date and time of autotest procedure and its result).

To preview particular autotest data, press a respective table line.

In order to print a result of a single autotest, enter its details (see above) and generate a printout by pressing <Print> key located on the top of the display.

Autotest results can be exported by pressing <Export> entry in the window with all saved reports. Data is sent to a USB flash drive, connected to the balance USB port, as a \*.csv file.

## 21.15. Start-Up Logo

*(option enabled only for authorized operators)*

The parameter enables you to change the logo that is displayed at the moment of balance start-up.

## 21.16. Export of System Events

*(option enabled only for authorized operators)*

The parameter enables you to generate a special type of file that is automatically saved to a USB flash drive, plugged to the USB port. The file helps RADWAG service to diagnose the cause of problems occurring during balance operation.

### Procedure:

- Plug a USB flash drive to the balance USB port.
- Enter <Misc.> submenu.
- Select <Export system events> parameter.
- The software generates a file and automatically saves it on the USB flash drive.
- The generated file has to be sent to RADWAG.



## 21.17. Text-to-speech conversion







Parameter for enabling the processing of group names and menu parameters into speech emitted from the indicator speakers. The emitted voice is only in English.

## 22. SCHEDULED TASKS

This parameter provides settings for planning a cyclic performance of particular operations, e.g. balance adjustment or display of prompts.

### 22.1. Adjustment

← Edit record  

 Name	 Code
 Planned operation	Automatic adjustment <input checked="" type="checkbox"/> Active <input type="checkbox"/>
 First operation date and time	2023.03.23 12:08:46  Interval 24 h
 Message	

<Scheduled adjustments> parameter allows you to precisely specify the time for adjustment performance and the interval between successive adjustments. The parameter is not connected with automatic adjustment and its criteria (time, temperature). You can schedule when internal and external adjustments are to be performed. In order to design a

schedule for external adjustment, it is necessary to record mass standards for adjustment performance into the balance memory.

**Procedure:**

Enter data of mass standards intended for external adjustment performance; to do it: Enter operator menu, select <Adjustment> submenu and find <Adjustment weights> parameter.

← Edit record 🖨️ 🔄

Name	ETALON 100 g	Code	1234
Class	E2	Serial number	654321
Mass	100 g	Set number	KP 01





	<p>Enter operator menu, select &lt;Scheduled tasks&gt; parameter. A window opens in which an authorised user (Administrator) can add entries with scheduled adjustments.</p>
	<p>In order to add a new entry, press  button, wait for a window with data on the scheduled adjustment to open.</p>
<p>Empty space</p>	<p>Select task: automatic adjustment (internal or external).</p>
	<p>For automatic adjustment option, enter data on the adjustment and its schedule.</p>
	<p>For external adjustment option, enter data on the adjustment, mass standard used for the adjustment performance and its schedule.</p>
	<p>When all necessary data has been introduced, return to the previous window. The window features newly added entry.</p>

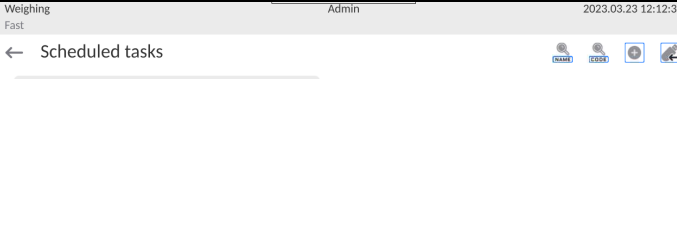

Upon entering all data, exit the menu.

Now all the adjustments are carried out automatically as scheduled and with specified time intervals.

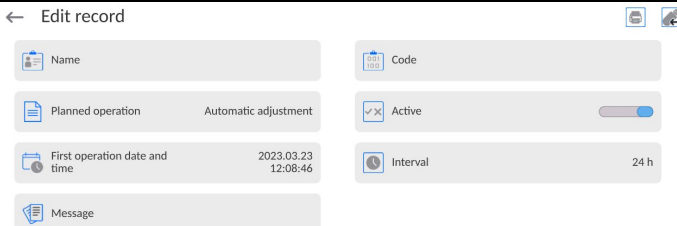
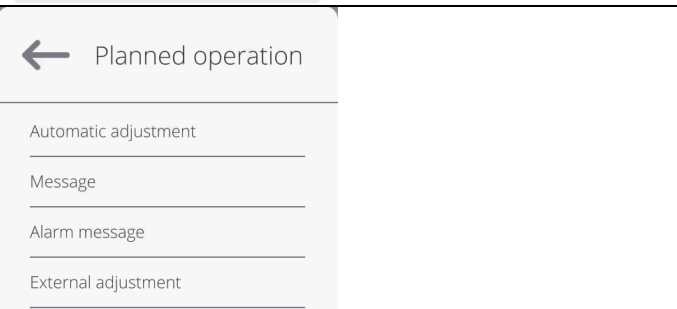
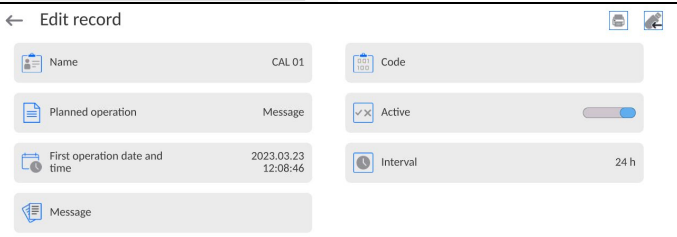
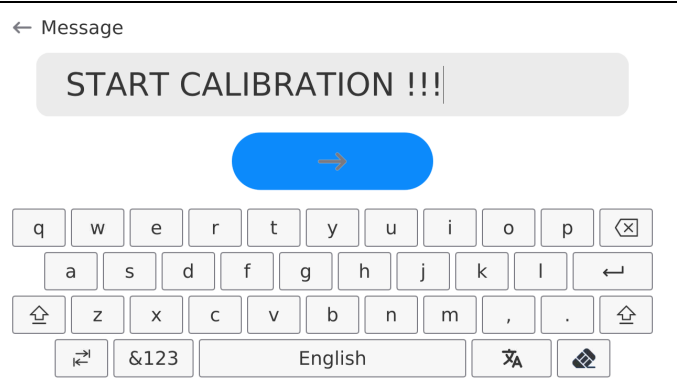
## 22.1. Message

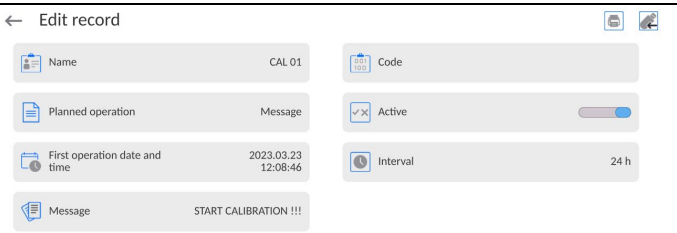
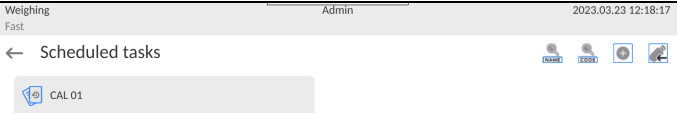
This parameter enables to declare precise time and time interval for display of a special prompt informing the user on the necessity to take up a particular action.

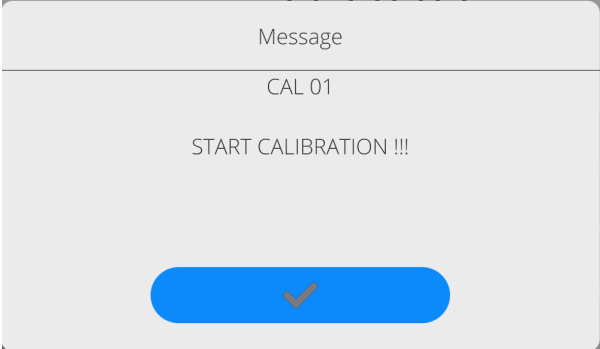
	<p>Enter user menu, next enter &lt;Scheduled tasks&gt; submenu. In order to add an operation, press  button placed in a toolbar.</p>
	<p>&lt;Edit record&gt; box is displayed, press &lt;Scheduled tasks&gt; field. &lt;Scheduled tasks&gt; box is displayed.</p>
	<p>Select &lt;Message&gt; option.</p>
	<p>Message settings box is displayed. Set message display frequency (first display, time interval), select &lt;Message&gt; parameter and enter message text.</p>
	<p>Press  button to confirm.</p>
	<p>A previous window is displayed.</p>
	<p>In &lt;Scheduled tasks&gt; box, a newly added operation is displayed. Go to the home screen.</p>

	<p>When message display criterion is met (time), message box is displayed automatically.</p> <p>Press &lt;  &gt; button, the message box gets closed, perform the operation.</p>
---	--



## 23. UPDATE

Update function enables update of:

- User-related area: APPLICATION.
- Main board (administrator exclusively).

Update takes place automatically by loading data from a USB flash drive connected to the balance USB port.

### Procedure:













- Prepare a USB flash drive with the update file. Required file extension: *\*.lab4*.
- Connect the USB flash drive to the USB port of the indicator.
- Log in as the Administrator.
- Press  button to enter the balance menu.
- Select <Update>  option.
- Select <Application> field.
- The display previews the content of the USB flash drive; search for the update file and press its name.
- The balance is automatically restarted, and the balance application is automatically updated.
- If the balance does not restart, force it to restart by turning it off and on again.

Update of the main board file is analogous; required file extensions are: \*.cm4mbu – main board.

## 24. ABOUT

'About' menu provides information on the balance and balance program. Most parameters in this menu are for the information purpose only.

← About

 Balance S/N	0	 Balance type	XAM 3Y
 Network balance name	PUE10-2a45a2e9	 Software version	LL2.0
 Product code	000700404070	 Weighing firmware version	1.0.0
 Product code 2	429048443000	 Software rev. MB	1.1.3
 System version	LX-23.03.21	 CPU Id:	48560360
 Licence Id:	E4-5F-01-E5-41-E8	 Memory status	FLASH: 57 % RAM: 16 %

<Ambient conditions> parameter enables preview of current ambient conditions: temperature, humidity, pressure (if the balance features ambient conditions sensors).

<Print settings> parameter enables you to send all parameters to a printer port.

## 25. COMMUNICATION PROTOCOL

	<b><i>Detailed description of protocol of communication between the balance and the computer is to be found in 'CBCP-07' manual.</i></b>
---	--

### 25.1. Manual Printout / Automatic Printout

It is possible to generate printouts either manually or automatically.

- Manual printout: wait for a stable indication and press  button.
- Automatic printout is generated automatically in accordance with the parameters set for the automatic printout (read section 13.5).

The content of a printout depends on the settings of <Standard printout> parameter - <Weighing printout template> (read section 13.5).

#### Mass printout format:

1	2	3	4 -12	13	14	15	16	17	18
stability marker	space	character	mass	space	unit			CR	LF

Stability marker	[space] if stable [?] if unstable [!] if air buoyancy compensation function is on
------------------	---



	[^] if high limit is out of range [v] if low limit is out of range
Character	[space] for positive values [-] for negative values
Mass	9 characters with decimal point, right justification
Unit	3 characters, left justification

**Example:**

\_\_\_\_ \_ 1 8 3 2 . 0 \_ g \_ \_ CR LF - a printout generated,  
with reference to <Weighing printout template> settings, from a balance upon pressing



key:

N (measurements quantity)	<b>NO</b>	Universal variable 1 ... 5	<b>NO</b>
Date	<b>NO</b>	Net	<b>NO</b>
Time	<b>NO</b>	Tare	<b>NO</b>
Level status	<b>NO</b>	Gross	<b>NO</b>
Customer	<b>NO</b>	Current result	<b>NO</b>
Warehouse	<b>NO</b>	Supplementary unit	<b>NO</b>
Product	<b>NO</b>	Mass	<b>Yes</b>
Packaging	<b>NO</b>	Non-standard printout	<b>NO</b>

## 26. CONNECTING PERIPHERALS

The 5Y series balance can operate with the following peripheral devices:

- computer,
- receipt printer,
- PCL6 printer, (*Printer Command Language*),,
- barcode scanner,
- fingerprint reader,
- peripheral device operating in ASCII communication protocol.

**Caution:** Only accessories listed on the RADWAG website can be connected to the balance.

## 27. ERROR MESSAGES

---

Max weighing threshold exceeded  
Unload the weighing pan

---

---

Min weighing threshold exceeded  
Install weighing pan

---

---

Zeroing out of range  
Press tarring button or restart the balance

---

---

Display capacity out of range  
Unload the weighing pan

---

---

Tarring out of range  
Press zeroing button or restart the balance

---

---

Start mass out of range  
Install weighing pan

---

---

Zeroing/tarring time out of range  
Weighing indication unstable

---

-no level- Balance not levelled

-Err 100- Weighing module restart

In process An ongoing process in the course of which the indication may be unstable  
(automatic feeder – the process of feeding a pill, or mass comparator – the  
process of load change)

























## 28. ADDITIONAL EQUIPMENT























Type	Name
RTP-UEW80 or RTP-RU80	Dot printer
	PCL6 Printer
LS2208	Barcode scanner
	PC keyboard

PC software:

- „LABEL EDITOR”

## 29. ANNEX B – Programmable Buttons List

Pictogram	Name
	None
	Mass standard magnetism
	Profile selection
	Adjustment
	Working mode
	Products
	Packaging selection
	Customers
	Operator
	Warehouses
	Zero
	Tare
	Tare setting
	Disable tare
	Enable tare
	Print
	Header printout
	Footer printout / C label
	Print CC label
	Lot no.
	Batch no.
	Edit universal variable 1
	Edit universal variable 2
	Edit universal variable 3
	Edit universal variable 4

	Edit universal variable 5
	Statistics
	Add to statistics
	Zero statistics
	Zero CC statistics
	Zero all statistics
	Print and zero statistics
	Print and zero CC statistics
	Label count
	C label count
	CC label count
	Logout
	Parameters
	Working mode
	Units
	Help
	Create screen shot
	Voice message
	Disable last digit display
	Disable display of last two digits
	Disable display of last three digits
	Accept
	Abort



**RADWAG BALANCES AND SCALES**  
ADVANCED WEIGHING TECHNOLOGIES

