

PUE HX5.EX

WEIGHING INDICATOR

USER MANUAL

ITKU-98-04-12-18-EN













 **RADWAG BALANCES AND SCALES**
ADVANCED WEIGHING TECHNOLOGIES

DECEMBER 2018

PRECAUTIONS

Prior installation, use or maintenance activities, carefully read this User Manual. Use the PUE HX5 EX-* indicator only as intended. This user manual must be at a reach of the operator's hand in the course of device operation.

	Symbol marking sections that are extremely important for protection against explosion.
	The device must be applied in accordance with the intended use only.
	Prior installation and start, it is necessary to analyse whether the device complies with the usage requirements regarding particular hazardous area.
	In case of any sign of damage, it is necessary to disconnect the device from the mains immediately. The damaged component must be replaced or repaired by RADWAG service immediately.
	While installing the device, it is necessary to follow strictly this user manual requirements. Not adhering to the requirements results with loss of explosion safety.
	The PUE HX5.EX-* indicator can be connected only to intrinsically safe devices that are enumerated in this user manual, or to certified instruments characterised with respective intrinsically safe parameters, described further down this document. Connection method must be accordant with this user manual requirements. Connecting other than intrinsically safe or certified device, results with loss of explosion safety of the complete set.
	The PUE HX5.EX-* indicator may be used as a component of device/set intended for operation in hazardous area. Manufacturer of such device/set is obliged to carry out analysis of the complete device/set in order to confirm compliance with standards.
	The device must be connected to the grounding permanently.
	It is not allowed to use the device in places, where mechanisms causing electrostatic charges greater than those caused by rubbing the surface by hand, occur.
	Do not apply protection shields.
	Technical condition of the indicator must be tested and inspected by a trained personnel, in accordance with this user manual, at least once every three months.

CONTENTS

1. INTENDED USE	6
2. USAGE CONDITIONS	6
2.1. Supplying the PUE HX5.EX-* Indicator with Power.....	6
2.2. Electrostatic Charges Hazard.....	7
2.3. Device with Permanently Fixed Wires.....	7
2.4. Load Cells.....	7
3. WARRANTY CONDITIONS	7
4. SAFETY REQUIREMENTS	8
4.1. ATEX Markings – Symbols Meaning.....	9
4.2. Data Plates.....	10
4.3. Information Stickers Arrangement.....	11
5. TECHNICAL CONDITION INSPECTION	11
6. MAINTENANCE ACTIVITIES	12
7. SERVICE AND REPAIR	12
8. UTILISATION	13
9. MECHANICAL DESIGN	13
9.1. Main Components.....	13
9.2. Overall Indicator Dimensions.....	15
9.3. Operation Panel.....	15
9.4. Technical Specifications.....	17
9.5. Models.....	17
9.6. Connectors Arrangement.....	17
9.6.1. RS232, RS485 Connectors.....	18
9.6.1.1. Pins Assignment.....	19
9.6.1.2. Intrinsic Safety Parameters.....	19
9.7. Digital Inputs and Outputs.....	20
9.7.1. In/Out Cables Marking.....	20
9.7.2. Intrinsic Safety Parameters for IN/OUT Circuits.....	21
9.7.3. Technical Specifications for IN/OUT.....	22
9.8. Permissible Inputs/Outputs Configuration.....	22
9.8.1. Active Inputs.....	22
9.8.2. Passive Inputs in Ex Zone.....	23
9.8.3. Passive Inputs Outside Ex Zone.....	23
9.8.4. Active Outputs.....	25
9.8.5. Passive Outputs in Ex Zone.....	25
9.8.6. Passive Outputs Outside Ex Zone.....	26
10. INSTALLATION	28
10.1. Unpacking and Preparing for Operation.....	28
10.2. Workstation.....	28
10.3. Grounding.....	29
10.4. Connecting Power Supply.....	30
11. START-UP	32
12. HOME SCREEN	32
12.1. Top Bar.....	32
12.2. Weighing Result Window.....	33
12.3. Workspace.....	33
12.4. Pictograms.....	33
13. OPERATING THE MENU	34
13.1. Entering the Menu.....	34
13.2. Menu Keys.....	34
13.3. Entering Numeric and Text Characters and Signs.....	35
13.4. Return to the Weighing Mode.....	35

14. INSTALLER INSTRUCTION.....	36
14.1. Connecting Load Cells - PLATFORM Analog Interface.....	36
14.2. Intrinsic Safety Parameters.....	38
14.3. 6-Wire Load Cell Connection.....	38
14.4. 4-Wire Load Cell Connection.....	39
14.5. Multiple Load Cells Connection.....	40
14.5.1. Load Cell Platforms.....	40
14.5.2. Weighing Modules - Solder Type Connection.....	41
14.5.3. Weighing Modules - Connections on Junction Box Board.....	42
15. FACTORY SETUP.....	42
15.1. Access to Factory Setup.....	42
15.1.1. Global Parameters List.....	43
15.1.2. Factory Parameters List.....	44
15.2. Factory Adjustment.....	45
15.2.1. External Adjustment.....	45
15.2.2. Start Mass Determination.....	46
15.3. Linearity Correction.....	46
15.3.1. Linearity Determination.....	46
15.3.2. Corrections.....	47
15.3.3. Deleting Linearity.....	47
15.4. Gravitational Coefficient.....	48
16. CONNECTION CABLES LIST.....	48
17. STANDARDS LIST.....	48

1. INTENDED USE

PUE HX5.EX-* is a versatile weighing indicator intended to form industrial scales based on load cells. Directive 2014/34/EU and IECEx Certification requirements, and can be used in environment filled with explosive gases and dust, classified as zones: 1, 2, 21, 22. The PUE HX5.EX-* indicator's functionality makes it a perfect solution for numerous industry applications.

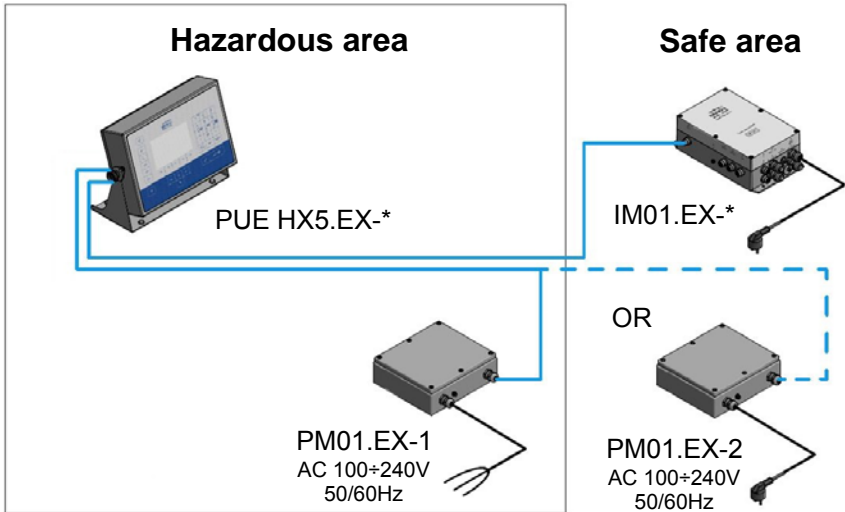

The standard version of the indicator is equipped with the following communication interfaces enabling cooperation with devices placed in the hazardous area: 2 x RS232, RS485, digital 4IN/4OUT (optionally). The indicator can be connected to the mains only via an intrinsically safe power supply, PM01.EX-1 or PM01.EX-2. It is possible to connect the PUE HX5.EX-* indicator to IM01.EX-* communication module, placed outside the hazardous area. Due to its intrinsically safe interface, the IM01.EX-* module can expand the indicator's interfaces range: Ethernet, RS232x2, RS485, digital 12IN/12OUT, USB, analog outputs, PROFIBUS.

2. USAGE CONDITIONS

2.1. Supplying the PUE HX5.EX-* Indicator with Power

The PUE HX5.EX-* indicator must be powered using either PM01.EX-1 or PM01.EX-2 power supply, both of them manufactured by RADWAG WAGI ELEKTRONICZNE Witold Lewandowski, Radom, EU-type examination certificate KDB 17ATEX0066X and IECEx OBAC 19.0001X certificate.

2.2. Electrostatic Charges Hazard

In order to minimize electrostatic charges hazard it is necessary to:

- make sure that the device is permanently grounded in the course of operation,
- follow cleaning-relevant recommendations that are to be found in section 6 of this user manual.

2.3. Device with Permanently Fixed Wires

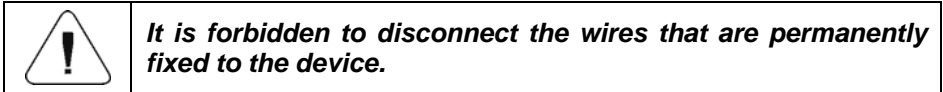

2.4. Load Cells

For construction of weighings platforms it is necessary to use exclusively load cells guaranteeing „ia” or „ib” intrinsic safety, confirmed by ATEX or IECEx certificate.

3. WARRANTY CONDITIONS

- A. RADWAG feels obliged to repair or exchange all elements that appear to be faulty by production or by construction.
- B. Defining defects of unclear origin and means of their elimination can only be realized with assistance of manufacturer and user representatives.
- C. RADWAG does not bear any responsibility for damage or losses resulting from misuse, or unauthorized use or servicing.
- D. The warranty does not cover:
 - mechanical damage caused by product exploitation other than intended, damage of thermal and chemical origin, damage caused by lightning, overvoltage in the power network or other random event,
 - inappropriate cleaning habits.
- E. Loss of warranty takes place if:
 - a repair is carried out outside RADWAG authorized service point,
 - service claims intrusion into mechanical or electronic construction by unauthorized people,
- F. For detailed warranty conditions read the warranty certificate.
- G. Contact with the central authorized service: +48 (48) 386 63 30.

4. SAFETY REQUIREMENTS

Prior the first use, carefully read this User Manual. Use the weighing device only as intended.

PUE HX5.EX-* indicators can be operated in:

- zones 1 and 2 where there is a risk of explosion due to mixture of air with vapour, mist or gas, classified as explosion group IIC, IIB and IIA and as temperature class T1, T2, T3, T4,
- zones 21 and 22 where there is a risk of explosion due to mixture of air with dust, flammable fibres and volatile fuels, classified as explosion group IIIC, IIIB and IIIA.



All instruments connected to indicator's digital IN/OUT and connectors, require 'ia' or 'ib' protection.

Explosion safety of PUE HX5.EX-* indicator is ensured by:

- Intrinsically safe design of the PUE HX5.EX-* indicator, adhering to regulations of EN 60079-0 and EN 60079-11.
- EU-type examination certificate, UE KDB 17ATEX0066X, and IECEx OBAC 19.0001X certificate.
- Use of certified RADWAG-manufactured power supplies (exclusively):
 - PM01.EX-1 power supply intended for operation in zone where there is an explosion risk, zones: 1, 2, 21 and 22.
 - PM01.EX-2 power supply intended for operation in safe area, equipped with intrinsically safe circuits which may be placed in zones 1, 2, 21 and 22.
- Not exposing the indicator to static electricity. Functional grounding cable which levels the potentials must always be connected to the marked terminal. Disconnecting the functional grounding cable is forbidden. Disconnecting potentials equalizing cable (e.g. when there is a need to place the device elsewhere) is allowed only if there is no risk of explosive atmosphere.
- **Adhering to this user manual guidelines.**

4.1. ATEX Markings – Symbols Meaning



II 2 G Ex ib IIC T4 Gb

Equipment group:
 I - to be used in mines where there's risk of mine gas explosion
 II - to be used in places where there's risk of explosion of gases other than mine gases

Types of group II devices:
 1 - equipment providing very high protection level,
 - for operation in zone 0,1,2
 2 - equipment providing high protection level,
 - for operation in zone 1,2
 3 - equipment providing standard protection level,
 - for operation in zone 2

Explosive atmosphere:
 G - caused by mixture of air with vapour, mist or gas
 D - caused by mixture of air with dust

Electrical equipment corresponding with one or several anti-explosion mechanical designs

Symbol of used explosion proof mechanical design, e.g.:
 mb - hermetic, for operation in zone 1,2,
 tb – protection via housing for operation in zones 1,2,
 e - increased safety
 ia - intrinsically safe design for operation in zone 0,1,2,
 ib - intrinsically safe design for operation in zone 1,2.

Gas explosion group, examples:
 - IIA: propane (T1) benzene (T3) butane (T2) ethanol (T2)
 - IIB: ethylene (T2)
 - IIC: acetylene (T2) hydrogen (T1)
 or dust, examples:
 - IIIA: volatile fuels
 - IIIB: non-conductive dust
 - IIIC: conductive dust

Max surface temperature:
 - for gases it is specified as temperature class determining max surface temperature of device components that are in touch with explosive mixture:
 T1: 450 °C
 T2: 300 °C
 T3: 200 °C
 T4: 135 °C
 T5: 100 °C
 T6: 85 °C
 - for dusts it is specified as max measured surface temp, e.g.:
 T60°C

Protection class gas atmosphere:
 - Ga
 - Gb
 - Gc
 dust atmosphere:
 - Da
 - Db
 - Dc

4.2. Data Plates

Data plates of PUE HX5.EX-* weighing indicator:

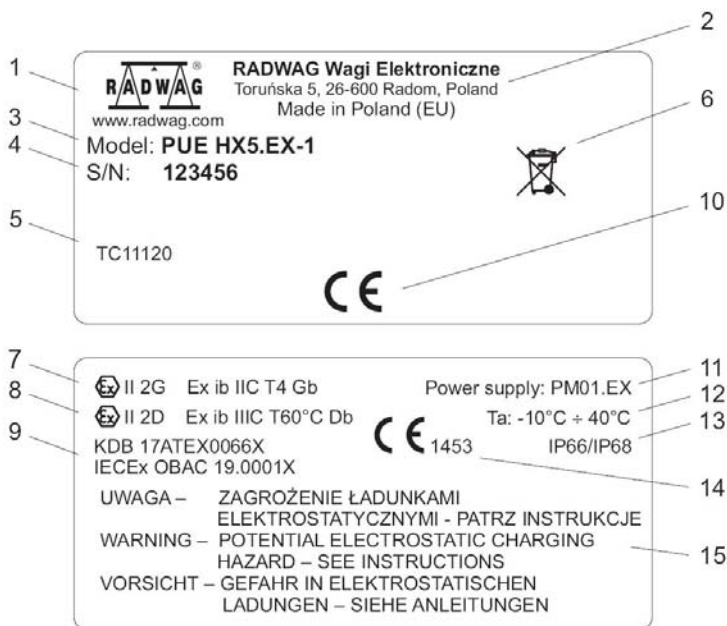

1	Manufacturer's logo.
2	Manufacturer's name and address.
3	Indicator model.
4	Serial no.
5	Metrological approvals numbers.
6	WEEE symbol.
7	Ex mark: gases (read section 4.1).
8	Ex mark: dusts (read section 4.1).
9	Numbers of ATEX and IECEx certificates of the indicator with „X” symbol - special conditions of use.
10	CE mark.
11	Power supply
12	Ambient temperature.
13	IP ingress protection.
14	CE mark with a number of notified body supervising quality of Ex device production.
15	Warning against danger with regard to electrostatic charges, written in Polish, English and German.

4.3. Information Stickers Arrangement

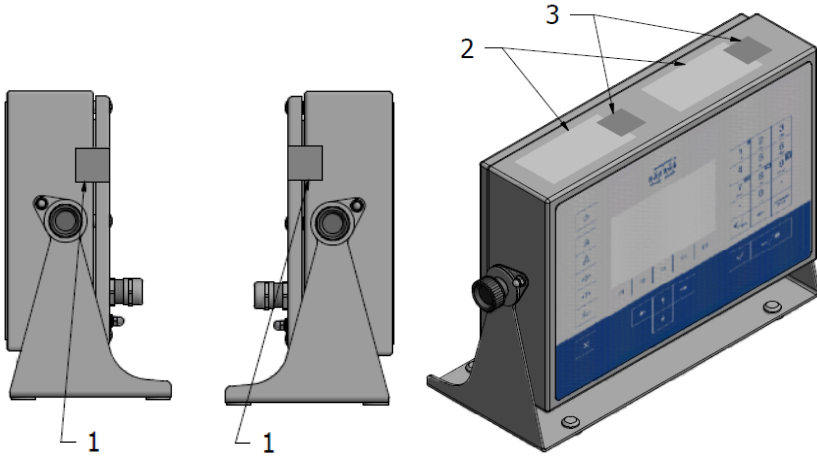

Arrangement of data plates and security stickers

1 - cover's security seals

2 - data plates

3 - data plates' security seals (in case of data plates of void seal type, the security seals are not used)

5. TECHNICAL CONDITION INSPECTION

	<p><i>The technical condition of the PUE HX5.EX-* indicator operated in the hazardous area must be tested and inspected by a trained personnel (familiar with this user manual content) at least once every three months.</i></p>
--	--





In the course of inspection check:

- Functional grounding state:
 - cable-housing connection,
 - connection resistance – Max. 100 Ω.
- Indicator keypad state – cuts, holes, detachment from the housing impermissible.
- Cable glands – loose wires impermissible:
 - gland-housing torque – 10 Nm,
 - gland's cup nut torque – 5 Nm.
- Hole plugs state – any unused connectors and ports must be covered.
- Data plates state – they must be complete (not broken/damaged etc.).

- Security stickers state - they must be complete (not broken/damaged etc.). Broken stickers are impermissible, they may cause loss of both explosion safety and warranty.
- Indicator cover - make sure it is closed.
 - cover screws torque – 0.5 Nm.

6. MAINTENANCE ACTIVITIES

Prior maintenance it is necessary to disconnect the indicator from the mains, and to check grounding connection and state. You can clean the indicator using regular household cleaners.

	<i>Clean the indicator when there is no risk of occurrence of explosive atmosphere.</i>
	<i>Clean the housing using a wet cloth. It is especially important if the indicator is operated in a room where there is dry air. Moisture protects against accumulation of electrostatic charges.</i>
	<i>Avoid using abrasive cleaners while cleaning the indicator's housing, do not use concentrated acids, bases, solvents or alcohol.</i>
	<i>It is not allowed to clean the indicator using compressed air.</i>

7. SERVICE AND REPAIR

	<i>If any damage of the device housing, display or keypad occurs, it is necessary to disconnect the device from the mains immediately. The damaged component must be replaced or repaired by RADWAG service immediately.</i>
---	---

In case of any problems with correct operation of the weighing indicator, contact the closest manufacturer's service point.

In case of defects, deliver the faulty product to the manufacturer's service point. If the product cannot be delivered to the manufacturer's service point, call the service and report the defect. Repair scope and method will be set up.



The user is NOT ALLOWED to carry out any kind of repair of the device himself/herself. Any attempt of indicator's mechanical design modification, repair etc., by unauthorized persons, will result with loss of validity of manufacturer-issued certificates, declarations and warranty.

8. UTILISATION

PUE HX5.EX-* indicators should be recycled, they are not to be treated as a regular household waste. Indicators to be decommissioned must be decommissioned in accordance with valid legal regulations.



9. MECHANICAL DESIGN

The PUE HX5.EX-* indicator is equipped with stainless steel housing, ensuring high IP rating, and 5" display, offering excellent readability. It is operated using 33-key membrane keypad equipped with programmable function keys. The housing features bracket which facilitates fixing the indicator to a wall, or placing it on a table. The bracket enables you to customize the inclination angle to your needs and preferences.

9.1. Main Components

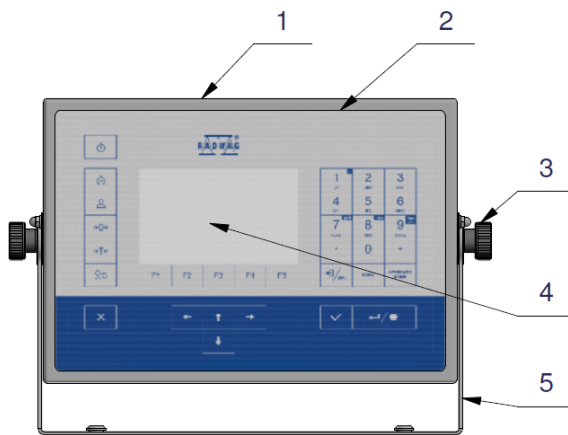

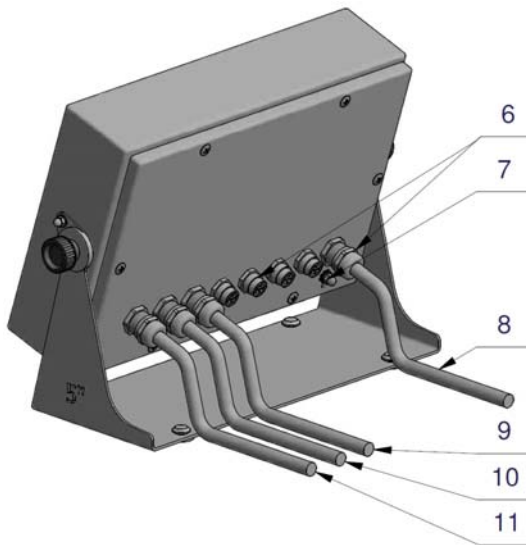

Main Components

1	Stainless steel housing.
2	Membrane keypad.
3	Knobs – inclination angle regulation.
4	Display.
5	Bracket.
6	Cable glands and connectors.
7	Grounding terminal.
8	Power cord.
9	Inputs cable.
10	Outputs cable.
11	Weighing platform cable.

9.2. Overall Indicator Dimensions

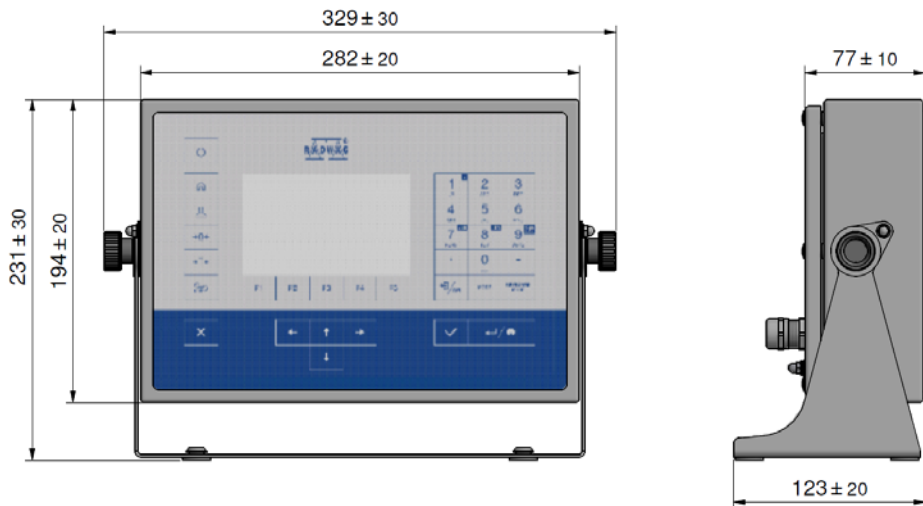





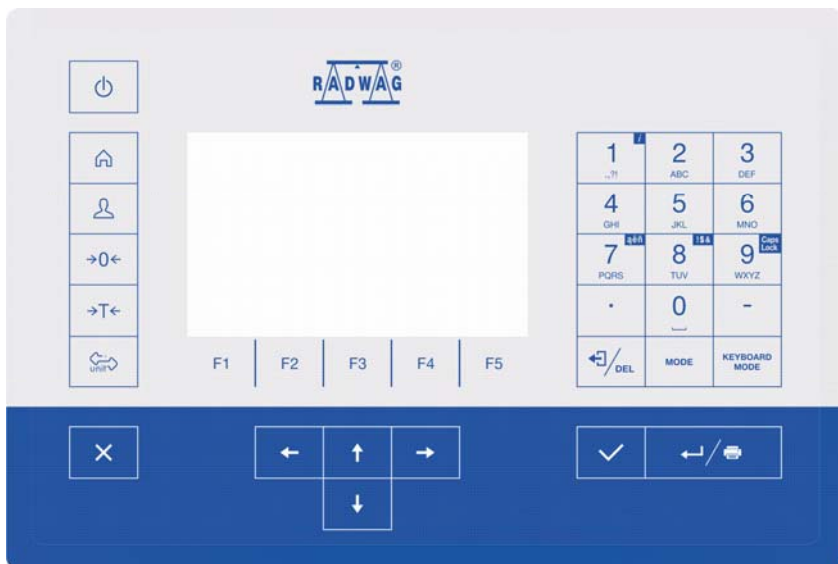











Overall indicator dimensions



9.3. Operation Panel



Keys:

	Press to switch the indicator on / off.
	Press to enter the main menu.
	Press to log in.
	Press to zero the scale.
	Press to tare the scale.
	Press to change the weighing unit.
	Press to cancel the message.
	Press to confirm the message.
	Press to change the working mode.
	Press to confirm the weighing result (PRINT). Press to confirm the messages (ENTER).
	Press to cancel the messages.
	Programmable key assigned to a pictogram displayed in the bottom screen area.
	Programmable key assigned to a pictogram displayed in the bottom screen area.
	Programmable key assigned to a pictogram displayed in the bottom screen area.
	Programmable key assigned to a pictogram displayed in the bottom screen area.
	Programmable key assigned to a pictogram displayed in the bottom screen area.

9.4. Technical Specifications

	PUE HX5.EX-*	
EX mark		II 2G Ex ib IIC T4 Gb or
		II 2D Ex ib IIIC T60°C Db or
		II 2G Ex ib IIC T4 Gb II 2D Ex ib IIIC T60°C Db
Housing	Stainless steel	
IP ingress protection by EN 60529	IP66/IP68	
Display	5" colour widescreen Resolution 800x480	
Keypad	Numeric + function keys	
Power supply	From an intrinsically safe RADWAG-manufactured PM01.EX-* power supply	
Ambient temperature	-10°C + 40°C	
Relative humidity	10+85% RH, non-condensing conditions	
OIML	III	
Maximum quantity of verification units	6000	
Maximum impedance of load cell	1200 Ω	
Minimum impedance of load cell	80 Ω	
Minimum voltage per verification unit	0.4µV	
Load cell connection	4 or 6 wires + shield	
Nominal voltage of load cell's power supply	5V DC	
Maximum number of connected platforms	1	

9.5. Models

There are 4 different models:



PUE HX5.EX-1: 2 x RS232, RS485 - standard design,

PUE HX5.EX-2: standard design + digital 4IN/4OUT,

PUE HX5.EX-3: standard design + digital 4IN,

PUE HX5.EX-4: standard design + digital 4OUT.

9.6. Connectors Arrangement

	<i>Since the indicator is intended for operation in hazardous area, its communication interfaces have been equipped with hermetic intrinsically safe connectors.</i>
	<i>Unused connectors and ports must be covered with hole plugs.</i>



The PUE HX5.EX-* indicator can be connected only to intrinsically safe devices that are enumerated in this user manual, or to certified instruments characterised with respective intrinsically safe parameters. Connection method must be accordant with this user manual requirements. Connecting other than intrinsically safe or certified device, results with loss of explosion safety of the complete set.

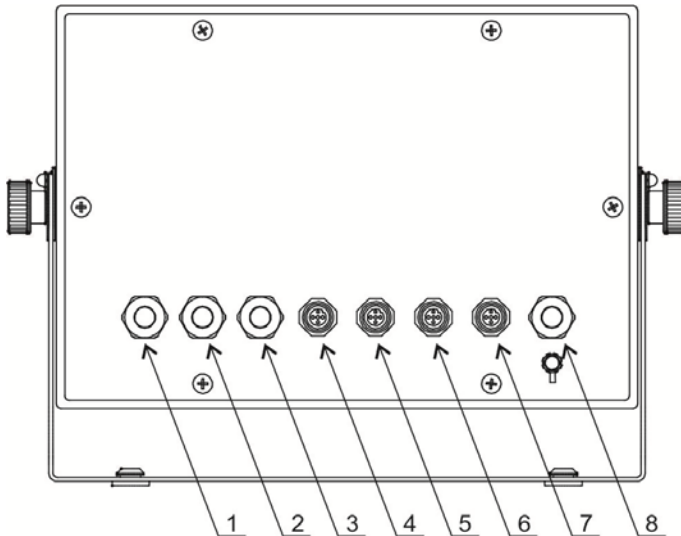

PUE HX5.EX- indicator connectors:*



- 1 – PLATFORM: cable gland for weighing platform,
- 2 – OUT: cable gland for outputs,
- 3 – IN: cable gland for inputs,
- 4 – RS232 (1): RS232 (1) connector,
- 5 – RS232 (2): RS232 (2) connector,
- 6 – RS485: RS485 connector,
- 7 – IM01.EX: communication module connector,
- 8 – PM01.EX: cable gland for intrinsically safe power supply.

9.6.1. RS232, RS485 Connectors



All instruments connected to indicator's RS232, RS485 connectors require 'ia' or 'ib' protection.

9.6.1.1. Pins Assignment

	Pin2 – RxD Pin3 – TxD Pin5 – GND	RS232 (COM1, COM2) M12 5P
	Pin1 - A Pin3 - B	RS485 M12 4P



9.6.1.2. Intrinsic Safety Parameters

RS232 interface, connectors marked as RS232 (1), RS232 (2):	
Uo	23.6V (±11.8V)
Io	81mA
Po	0.51W
Co	100nF
Lo	0.5mH
Li	negligibly small
Ci	negligibly small
Ui	24.2V (±12.1V)
Ii	40mA
Pi	any value
RS485 interface, connectors marked as RS485, IM01.EX:	
Uo	5.88V
Io	55mA
Po	81mW
Co	1.7µF
Lo	5mH
Li	negligibly small
Ci	negligibly small
Ui	6V
Ii	65mA

9.7. Digital Inputs and Outputs

PUE HX5.EX-* indicator optionally features 4 digital galvanically isolated inputs and 4 digital galvanically isolated outputs. Inputs and outputs are fed through separate cables via cable glands. On inputs and outputs connectors there is common power and ground for active inputs and/or outputs.

Inputs and outputs cables' insulation is removed at a length of about 150mm, cable wires are terminated with tubular end sleeves.

	<p><i>It is forbidden to connect electric potential and ground of internal power supply unit (Uo and GND on IN/OUT interfaces terminals of the indicator) with an external intrinsically safe power supply. This would result with loss of intrinsic safety.</i></p>
	<p><i>Under the threat of loss of intrinsic safety, the user must connect the supplied cables to the junction box of his/her electrical system. The connection must be done in accordance with Ex standard guidelines, and good engineering practice.</i></p>
	<p><i>All instruments connected to indicator's digital IN/OUT require 'ia' or 'ib' protection.</i></p>

Suggested solutions, Ex versions:

GL503.T-C9615,

GL703.T-C9620,

manufactured by Pepperl-Fuchs, or other models of likewise parameters.

9.7.1. In/Out Cables Marking

INPUTS		OUTPUTS	
WIRE NO.	SIGNAL	WIRE NO.	SIGNAL
1	I1-	1	O1B
2	I1+	2	O1A
3	I2-	3	O2B
4	I2+	4	O2A
5	I3-	5	O3B
6	I3+	6	O3A
7	I4-	7	O4B
8	I4+	8	O4A
9	Uo	9	Uo
10	GND	10	GND

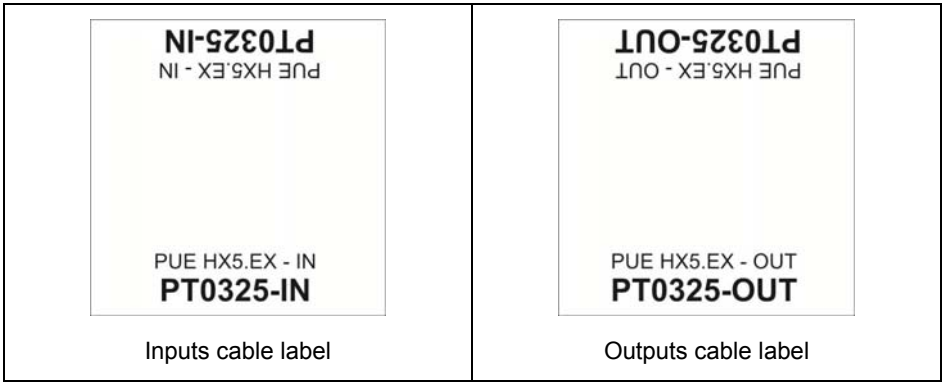

9.7.2. Intrinsic Safety Parameters for IN/OUT Circuits

OUT cables pairs (outputs): 1-2, 3-4, 5-6, 7-8	
U_i	30V
I_i	any value
P_i	0.49W
L_i	negligibly small
C_i	negligibly small
IN cables pairs (inputs): 1-2, 3-4, 5-6, 7-8	
U_i	30V
I_i	any value
P_i	any value
L_i	negligibly small
C_i	negligibly small
9-10 OUT cable pair (outputs) and 9-10 IN cable pair (inputs). CIRCUITS CONNECTED IN PARALLEL	
U_o	13.5V
I_o	42mA
P_o	0.52W
Total C_o	0.49 μ F
Total L_o	0.5mH

9.7.3. Technical Specifications for IN/OUT

Inputs parameters	
Inputs quantity	4
Inputs type	Galvanically isolated
Cable cross-section	0.5 – 1mm ²
Outputs parameters	
Outputs quantity	4
Outputs type	Galvanically isolated
Cable cross-section	0.5 – 1mm ²

9.8. Permissible Inputs/Outputs Configuration

This section provides examples of inputs and outputs connections. For all the cases it is necessary to adhere to rules for matching external devices to indicator's inputs and outputs with regard to intrinsic safety parameters.

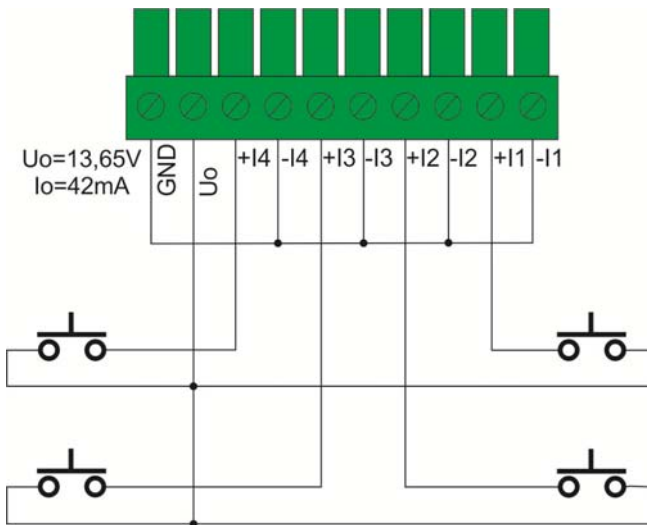

9.8.1. Active Inputs

Most frequently used configuration for operation in hazardous area. External buttons (relays contacts) are powered directly from the PUE HX5.EX-* indicator.



9.8.2. Passive Inputs in Ex Zone

Configuration intended to be used in hazardous area. External buttons (relay contacts) are powered using an external power supply. The external power supply must be an intrinsically safe device characterized with features corresponding to the existing explosive atmosphere.

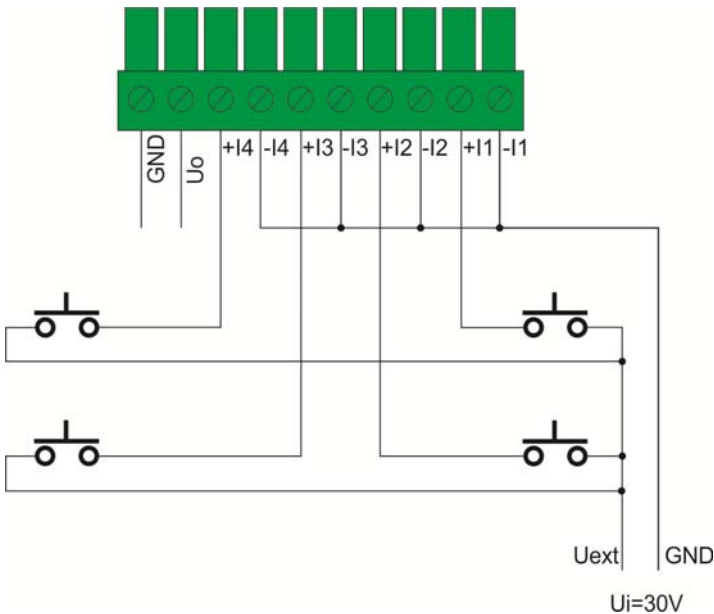

	<p><i>It is forbidden to connect electric potential and ground of internal power supply unit (U_o and GND on IN/OUT interfaces terminals of the indicator) with an external intrinsically safe power supply. This would result with loss of intrinsic safety.</i></p>
	<p><i>All instruments connected to indicator's digital IN/OUT require 'ia' or 'ib' protection.</i></p>



9.8.3. Passive Inputs Outside Ex Zone

Configuration intended to be used outside hazardous area. External buttons (relay contacts) are powered using an external power supply placed outside the hazardous area.

The power supply and the external buttons (relay contacts) are connected via relevant diode barriers.

	<p><i>It is forbidden to connect electric potential and ground of internal power supply unit (U_o and GND on IN/OUT interfaces terminals of the indicator) with an external power supply. This would result with loss of intrinsic safety.</i></p>
	<p><i>All instruments connected to indicator's digital IN/OUT require 'ia' or 'ib' protection.</i></p>

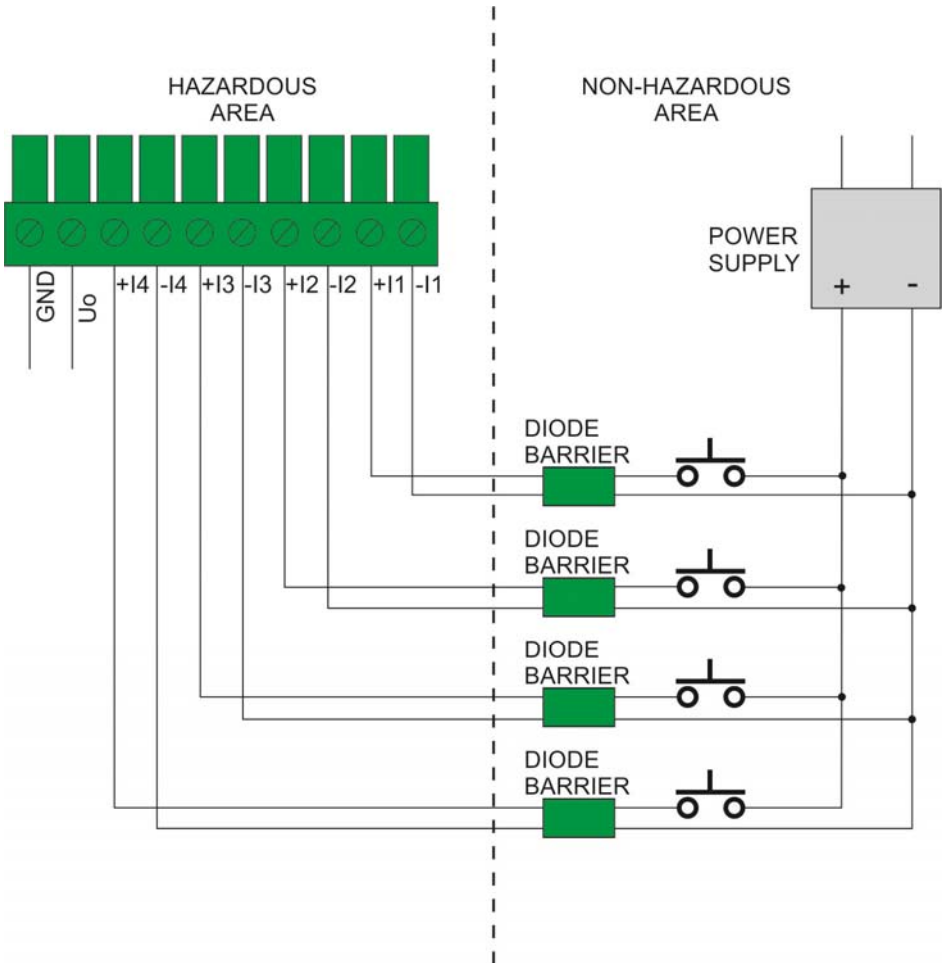

9.8.4. Active Outputs

Exemplary configuration intended to be used in hazardous area.

Outputs load (LOAD) is powered directly from the indicator. Maximum load of voltage source $U_o=13.65V$ cannot be greater than $I_o=42mA$ for all outputs in total.

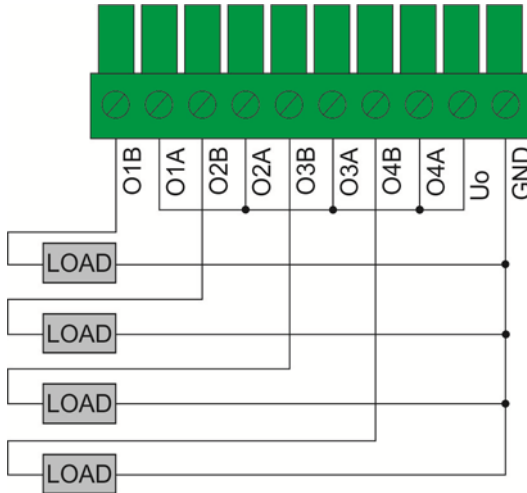

9.8.5. Passive Outputs in Ex Zone

Configuration intended to be used in hazardous area. Outputs load (LOAD) is powered using an external power supply.

The external power supply must be an intrinsically safe device characterized with features corresponding to the existing explosive atmosphere. The power supply must guarantee intrinsic safety parameters for the following conditions, $U_i=30V$ and $P_i=0.49W$.

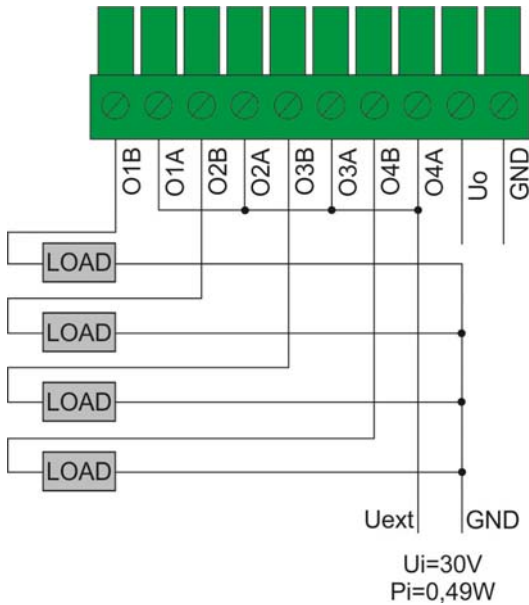

	<i>It is forbidden to connect electric potential and ground of internal power supply unit (U_o and GND on IN/OUT interfaces terminals of the indicator) with an external intrinsically safe power supply. This would result with loss of intrinsic safety.</i>
	<i>All instruments connected to indicator's digital IN/OUT require 'ia' or 'ib' protection.</i>



9.8.6. Passive Outputs Outside Ex Zone

Configuration intended to be used outside hazardous area. Outputs load (LOAD) is powered using an external power supply placed outside the hazardous area.

The power supply and the load (relay contacts) are connected via relevant „SWITCH AMPLIFIER”.

	<p><i>It is forbidden to connect electric potential and ground of internal power supply unit (Uo and GND on IN/OUT interfaces terminals of the indicator) with an external power supply. This would result with loss of intrinsic safety.</i></p>
	<p><i>All instruments connected to indicator's digital IN/OUT require 'ia' or 'ib' protection.</i></p>

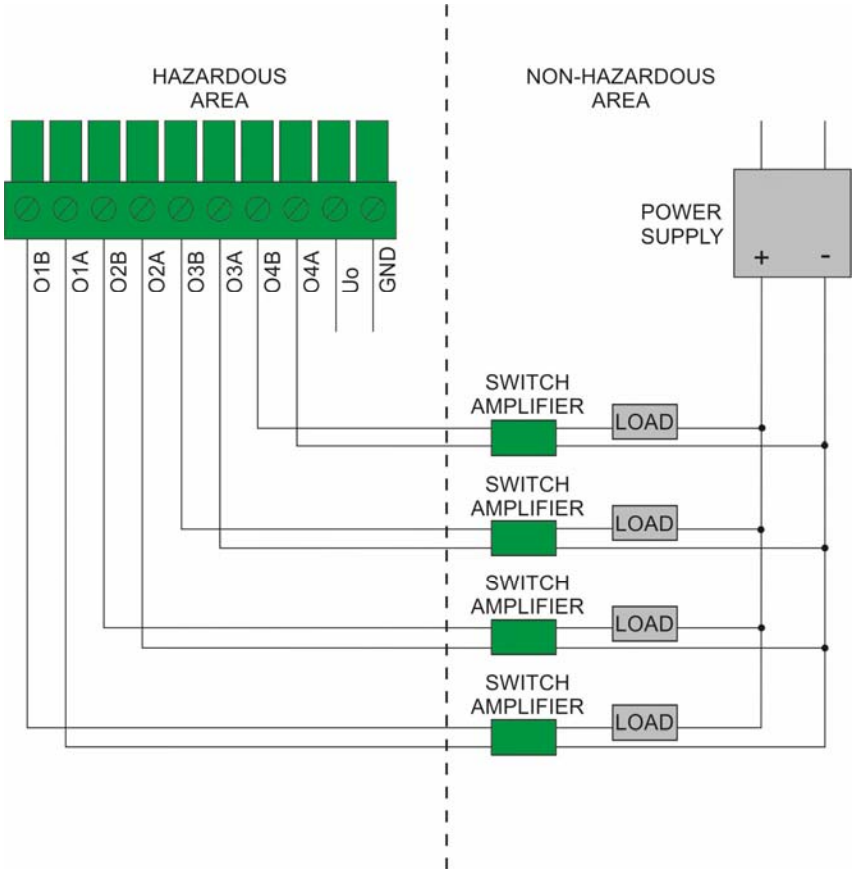

10. INSTALLATION

Prior the first use, carefully read this User Manual. Use the device only as intended. For details concerning 'indicator' - 'load cells' connection, read later sections of this user manual.

RADWAG does not bear any responsibility for damage or losses resulting either from improperly carried out installation or misuse.



Prior installation and start, it is necessary to analyse whether the device complies with the usage requirements regarding particular hazardous area. The analysis must be carried out by a qualified personnel.

10.1. Unpacking and Preparing for Operation

- The indicator must be unpacked in safe area.
- Prepare the workstation.
- Take the indicator to the workstation.
- Ground the indicator.
- Connect the indicator to the mains.



Install the weighing indicator, connect the weighing platform, and connect the grounding when there is no risk of explosive atmosphere occurrence.

10.2. Workstation

PUE HX5.EX-* indicator's workstation requirements:

- Dry, even, horizontal surface.
- Ambient temperature range: -10°C - +40°C.
- No heat source in a close vicinity, no risk of intense temperature variation.
- No mechanical shocks and vibrations.
- No exposure to mechanical or chemical stress (hazard).
- The workstation must be located in a considerable distance from processes where mechanisms causing electrostatic charges greater than those caused by rubbing the surface by hand, occur.
- No exposure to sunlight.
- At the workstation there must be MEB (main equipotential bonding) installed.

10.3. Grounding



In order to remove electrostatic charges it is necessary to ground the weighing indicator. Spots marked with „ \perp ” symbol are intended for the functional grounding cable.

- Prepare the functional grounding cable.
 - Use grounding cable of 4 mm² cross-section with yellow-green shield.
 - The functional grounding cable must be terminated with ring, of 5.2mm diameter, enabling you to couple the cable to the weighing indicator.
 - Use either toothed clamping washer or lock washer in order to keep the ring pressed tightly against the housing.
- Connect the functional grounding cable to the equipotential bonding and to the weighing indicator.
- Permissible resistance between the grounding terminal and the equipotential bonding is lower than 100Ω.



Indicator's grounding and grounding of the cooperating PM01.EX power supply must be connected to the same "equipotential circuit".



Connect the grounding when there is no risk of explosive atmosphere occurrence.

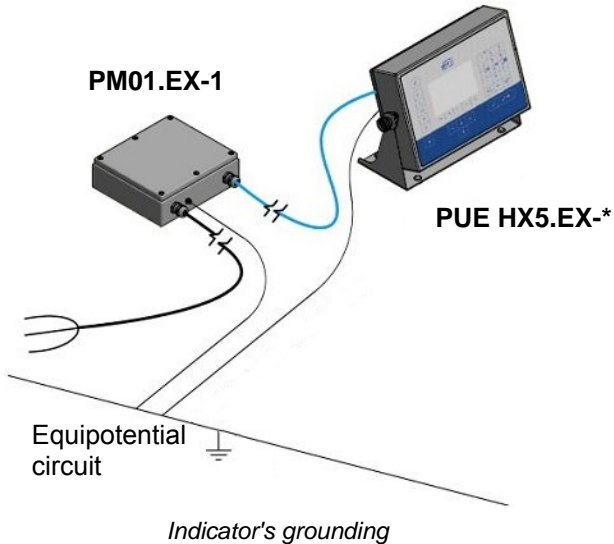



10.4. Connecting Power Supply

The PUE HX5.EX-* indicator can be connected to the mains only with a certified intrinsically safe power supply, manufactured by RADWAG:

- **PM01.EX-1** power supply intended for operation in hazardous area:
 - zone 1 and 2 where there is a risk of explosion due to mixture of air with vapour, mist or gas, classified as explosion group IIC, IIB and IIA and as temperature class T1, T2, T3, T4.
 - zone 21 and 22 where there is a risk of explosion due to mixture of air with dust, flammable fibres and volatile fuels, classified as explosion group IIIC, IIIB and IIIA.
- **PM01.EX-2** power supply intended for operation in safe area, equipped with intrinsically safe circuits which may be placed in:
 - zone 1 and 2 where there is a risk of explosion due to mixture of air with vapour, mist or gas, classified as explosion group IIC, IIB and IIA and as temperature class T1, T2, T3, T4.
 - zone 21 and 22 where there is a risk of explosion due to mixture of air with dust, flammable fibres and volatile fuels, classified as explosion group IIIC, IIIB and IIIA.

Connection of the PUE HX5.EX-* indicator to power supply is carried out by the manufacturer at the stage of production, the connection is of fixed type. If there is a need to disconnect the power supply, e.g. in order to run the cable through walls etc., it is allowed to disconnect the power cord from the power supply only.

	<i>Disconnect the indicator from the power supply when there is no risk of explosive atmosphere occurrence.</i>
	<i>Prior 'indicator' - 'power supply' cable disconnection, it is necessary to disconnect the power supply from the mains first.</i>
	<i>Disconnect the cable from the power supply EXCLUSIVELY.</i>

Detailed information concerning connection and disconnection of the cable from the power supply is to be found in an attached "**PM01.EX Intrinsically Safe Power Supply User Manual**".

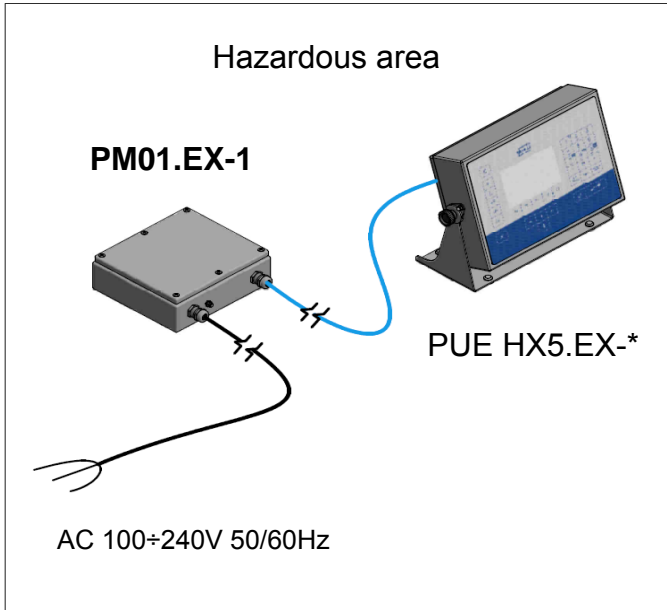

Indicator with a power supply in hazardous area

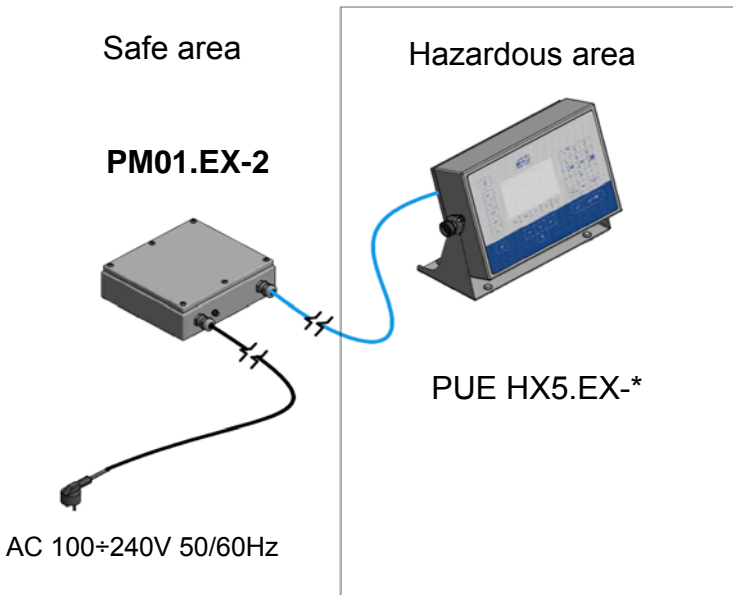

Indicator with a power supply placed outside hazardous area

11. START-UP

- Press  key, it is to be found on the top of the operation panel.
- Upon completed start-up the home screen is displayed automatically.

The weighing indicator is ready for operation (for detailed information concerning indicator's program read „PUE HX5.EX Indicator Software Manual”).

12. HOME SCREEN

The home screen features 4 sections: top bar, weighing result window, workspace, pictograms.



Home screen view:



12.1. Top Bar



The top bar displays the following information:

 Weighing	Working mode name and symbol.
PUE HX5.EX	Weighing device name.
	Symbol informing that printer is connected.
	Symbol informing that communication with a PC computer is on.

12.2. Weighing Result Window

Weighing result window provides all weighing related data.



12.3. Workspace

The workspace is to be found underneath the weighing result window.

Product:	Tare: 0.000 kg
User:	Sum: 0.000 kg

The workspace comprises 4 programmable widgets. Each working mode features default home screen widgets set. You can customize the screen. For detailed information concerning the workspace read section 'Display'.

12.4. Pictograms

The pictograms assigned to operation panel keys are to be found underneath the workspace.



You can define on-screen pictograms individually for each working mode.

	<i>For detailed information concerning the on-screen pictograms defining, read „PUE HX5.EX Indicator Software Manual”.</i>
---	---

13. OPERATING THE MENU

In order to navigate the program menu use the operation panel.

13.1. Entering the Menu



In order to enter the menu press  key of the operation panel. Background colour of the first menu position differs from the remaining ones.



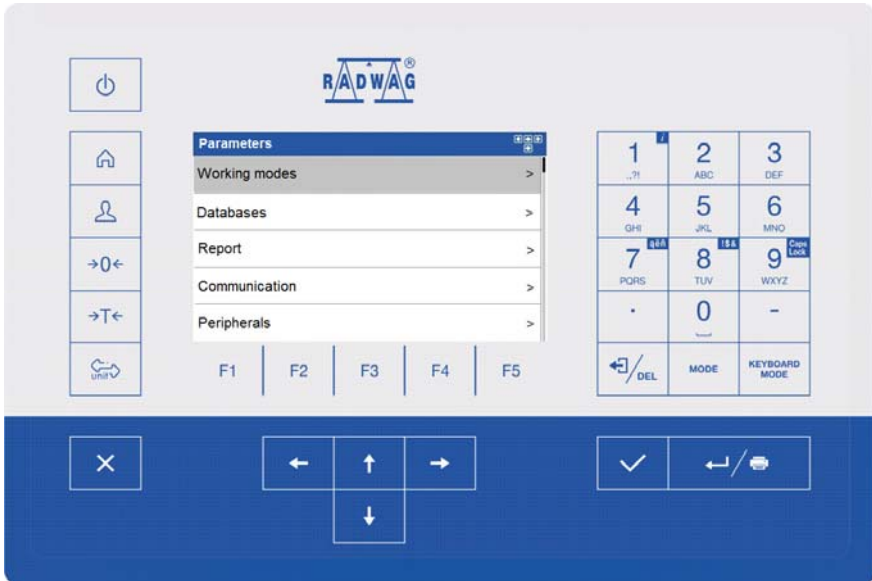



In order to navigate the program menu use the keys that operate as arrow keys.

Menu view



13.2. Menu Keys

	Press to enter the main menu. Press to go to home screen.
	Press to move one menu level up, or to discard entering parameter modifications.
	Press to move one menu level up. Press to delete a character when editing numeric and text values.

	Press to change keyboard mode when editing numeric and text values.
	Press to select/change working mode.
	Press to confirm/accept modifications.
	Press to move one menu level up, or to discard entering parameter modifications.
	Press to select higher-level parameters group, or to edit parameter value and change it by one digit up.
	Press to select parameters group that you want to operate. The first parameter of the selected parameters group is displayed.
	Press to select lower-level parameters group, or to edit parameter value and change it by one digit down.

13.3. Entering Numeric and Text Characters and Signs

Depending on a type of data entered to scale memory the software offers two different edit boxes:



- numerical box (for entering part mass values, tare values, etc.).
- text box (for entering printout template, universal variable value, etc.).

Button functions change depending on the edit box type.

	<i>For detailed instruction on numbers / text entering read „PUE HX5.EX Indicator Software Manual”.</i>
--	--



13.4. Return to the Weighing Mode



Introduced modifications are permanently recorded into scale memory upon return to the weighing operation, after carrying out saving procedure. To return to the home screen:

- press  key repeatedly, keep pressing the key until you see the home screen,
- press  key, the home screen is displayed immediately.

14. INSTALLER INSTRUCTION

PUE HX5.EX-* weighing indicator can be used as a base for designing load cell scales. The load cell scales are modular devices and they comprise:

- PUE HX5.EX-* weighing indicator.
- Certified, for conformity with Directive 2014/34/EU and IECEx certification requirements, PM01.EX-1 power supply, placed in hazardous area, or PM01.EX-2 power supply, placed outside hazardous area.
- IM01.EX communication module  II (2)G [Ex ib] IIC Gb and  II (2)D [Ex ib] IIIC Db, placed outside hazardous area.
- Load cell(s) certified for conformity with Directive 2014/34/EU and IECEx certification requirements, intended for operation in hazardous area, and characterized with parameters that meet requirements regarding intrinsic safety.
- Mechanical design compliant with requirements for non-electrical parts intended for use in hazardous areas (potentially explosive atmospheres).

	<i>Manufacturer of such device/set is obliged to carry out analysis of the complete device/set in order to confirm compliance with valid standards.</i>
	<i>Indicator's components selection is conditioned by level of protection against explosion of the whole set.</i>

14.1. Connecting Load Cells - PLATFORM Analog Interface

For designing scales based on PUE HX5.EX-* indicator, exclusively load cells intended for operation in hazardous area, issued with respective explosion safety certification, and meeting intrinsic safety requirements specified in this user manual, are used.

Procedure:

1. Remove security seals and evenly undo bolts (two turns) fixing the cover (10).
2. Remove the cover and undo gland's cup nut (8).
3. Lead the load cell's cable (of the weighing platform) (1) through the cable gland (2) signed as PLATFORM.
4. Take manufacturer-delivered ferrite core (3) and put it onto the cable.
5. Strip the cable (about 20cm).
6. Wind cable wires onto the manufacturer-delivered ferrite toroid bead (5).
DO NOT WIND THE CABLE SHIELD.
7. Fit heat-shrink tubing (9) onto both beads, make it shrink.

8. If necessary, cut the wires making them 5cm long (measured from the ferrite toroid bead).
9. Connect respective wires to load cell's interface (7) on the main board 466R1703.
10. Terminate the cable with a ring terminal of 4.3mm diameter and screw it to a threaded pin (6) on the indicator's housing.
11. Fit the cable into the cable clamp (4), use manufacturer-delivered cable tie.
12. Fix the cable in the cable gland preventing it from moving, do it by tightening the gland's cup nut (8), 5Nm torque.
13. Apply the cover and evenly screw the bolts (two turns) fixing the cover, torque 0,5Nm.
14. Apply security seals.

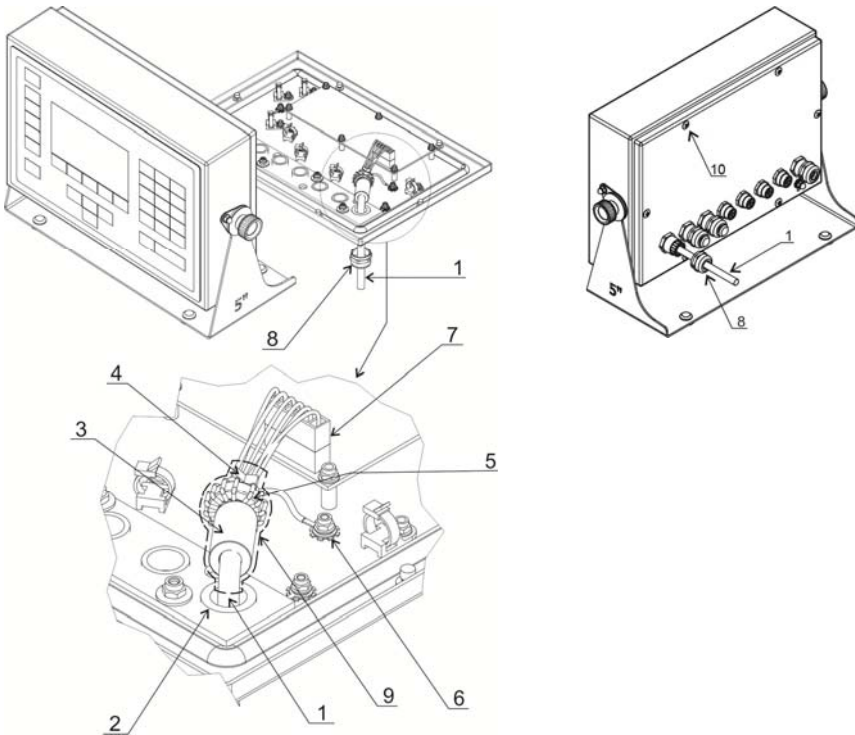

Load cells selection is conditioned by level of protection against explosion of the whole device.

14.2. Intrinsic Safety Parameters

Intrinsic safety parameters for analog interface, marked with PLATFORM sign, featuring permanently fixed connecting cable (used to connect load cells):

Uo	5.88V
Io	87mA
Po	0.51W
Co	1µF
Lo	110µH

14.3. 6-Wire Load Cell Connection

Connect 6-wire load cell to the main board following the diagram below:

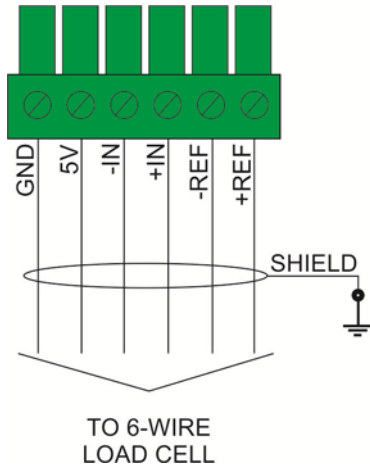

6-wire load cell connection

466R RADWAG board marking	Load cell signals
Housing	SHIELD
REF+	SENSE +
REF-	SENSE -
IN+	OUTPUT+
IN-	OUTPUT-
+5V	INPUT+
AGND	INPUT-

Use shielded cables of wire cross-section ranging from 0.25mm² to 1mm².

	<p>While selecting load cell, it is necessary to make sure that requirements regarding intrinsic safety parameters are met for measurement inputs/outputs marked +5V, E, AGND, REF+, REF-, +IN, -IN.</p>
---	---

14.4. 4-Wire Load Cell Connection

Connect 4-wire load cell to the main board following the diagram below:

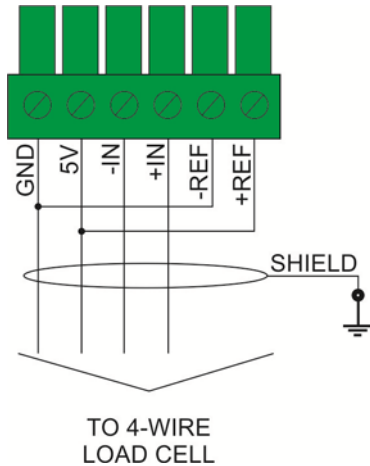

4-wire load cell connection

466R RADWAG board marking	Load cell signals
	SHIELD
IN+	OUTPUT+
IN-	OUTPUT-
+5V	INPUT+
AGND	INPUT-

Use shielded cables of wire cross-section ranging from 0.25mm² – 1mm².



While selecting load cell, it is necessary to make sure that requirements regarding intrinsic safety parameters are met for measurement inputs/outputs marked +5V, E, AGND, REF+, REF-, +IN, -IN.

14.5. Multiple Load Cells Connection

14.5.1. Load Cell Platforms

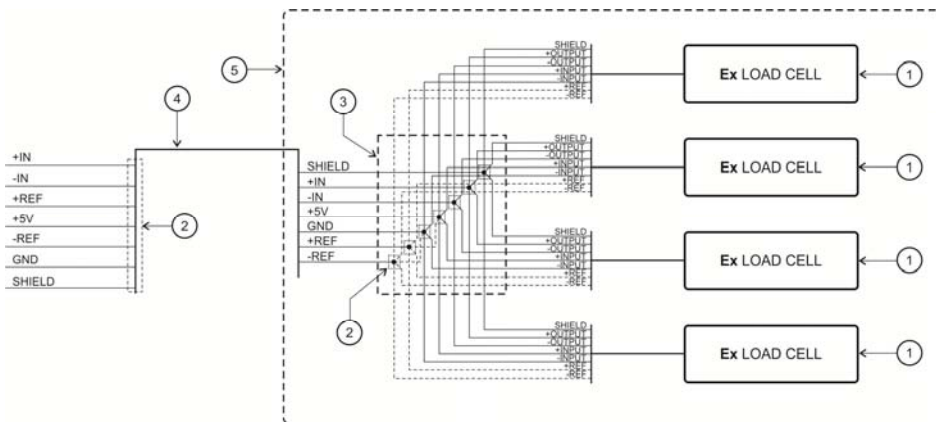

Solder type connection. Fit heat-shrink tubing with glue (for tightness purposes) onto each wire set (2), apply one tubing per one wire set. After shrinking, fit one heat-shrink tubing with glue onto all wire sets (3), apply one tubing per all sets. Apply heat-shrink tubing, thickness of which walls after shrinking is > 0.3mm.

No.	Pcs.	Name	Parameters	Notes
1	4	Load cell		Ex version
2	1	Heat-shrink tubing with glue	Thickness after shrinking > 0.3mm	
3	1	Heat-shrink tubing with glue	Thickness after shrinking > 0.3mm	
4	1	6-wire shielded cable	6 x min 0.25mm ² - max 1mm ² in shield	
5	1	Weighing platform		

14.5.2. Weighing Modules - Solder Type Connection

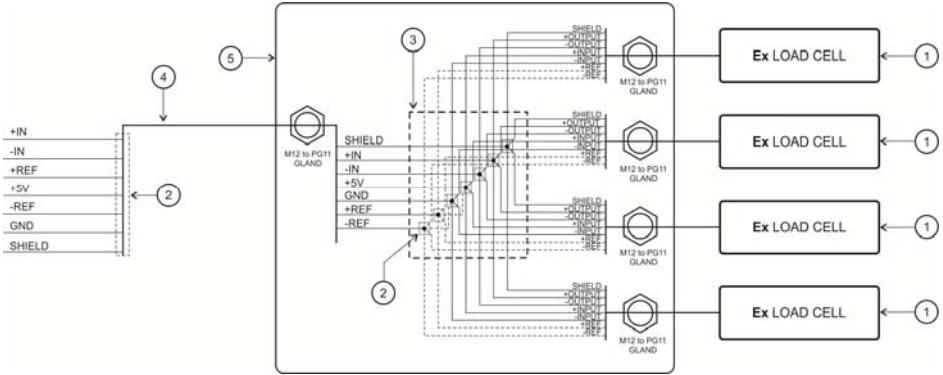

 **Solder type connection. Fit heat-shrink tubing with glue (for tightness purposes) onto each wire set (2), apply one tubing per one wire set. After shrinking, fit one heat-shrink tubing with glue onto all wire sets (3), apply one tubing per all sets. Apply heat-shrink tubing, thickness of which walls after shrinking is > 0.3mm.**

No.	Pcs.	Name	Parameters	Notes
1	4	Load cell		Ex version
2	1	Heat-shrink tubing with glue	Thickness after shrinking > 0.3mm	
3	1	Heat-shrink tubing with glue	Thickness after shrinking > 0.3mm	
4	1	6-wire shielded cable	6 x min 0.25mm ² - max 1mm ² in shield	
5	1	Junction box		

14.5.3. Weighing Modules - Connections on Junction Box Board

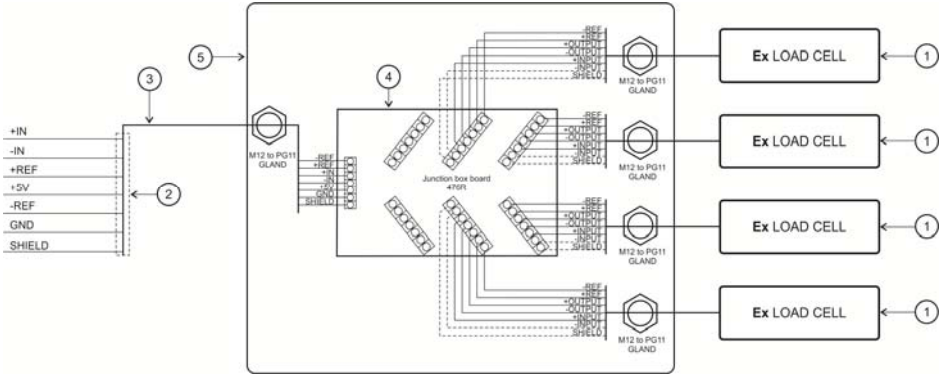

No.	Pcs.	Name	Parameters	Notes
1	4	Load cell		Ex version
2	1	Heat-shrink tubing with glue	Thickness after shrinking > 0.3mm	
3	1	6-wire shielded cable	6 x min 0.25mm ² - max 1mm ² in shield	
4	1	Junction box board	476R1710	
5	1	Junction box		



Strip load cells' cables and 6-wire cable (3), remove about 4cm of external insulation.

15. FACTORY SETUP



To access and modify factory settings and parameters that are made available for a user, run Factory Setup mode. Running Factory Setup mode enables defining the scale.

15.1. Access to Factory Setup

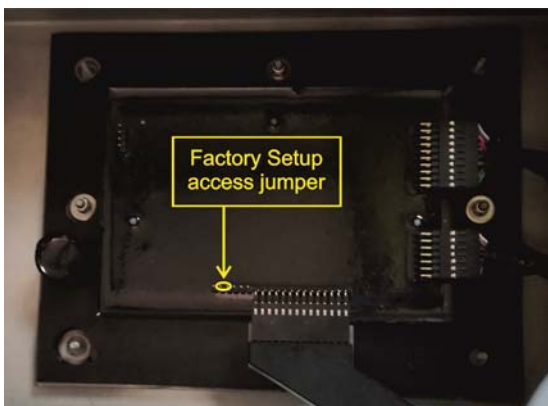

- Switch the weighing device off, to do it press  key.
- Put jumper to pins no. 2 and 3 of hermetic display module, see the photo.



Factory Setup access jumper



- Press  key to switch the weighing instrument on,
- Upon completed start-up procedure, weighing program window is displayed automatically,
- Press  key to enter Home Screen where two submenus are displayed:
 - **Global**,
 - **Factory**.

15.1.1. Global Parameters List

Name	Default	Range	Description
Metrological parameters	-	-	Weighing instrument name and metrological parameters.
Serial number	0	-	Balance serial number.
Customer	None	None, D, A, B, V, SC	Declaring the customer.
NTEP		 No,  Yes	Enabling / disabling modifications in „Parts Counting” mode for verified balances/scales (USA market).
Service	-	-	Service settings menu
RTC adjustment	-	-	RTC synchronisation.
Operation time	-	-	Total operation time, time format: "D: xx H: yy" (D - day, H - hour).
CPU Id	-	-	Processor no.
Restore default operator settings	-	-	Restoring default operator settings (factory and operator's parameters).

15.1.2. Factory Parameters List



Name	Default	Range	Description
Metrology	-	-	Metrology-connected settings
Mass divisions	-	-	Converter's divisions.
Adjustment unit	kg	g, kg, lb	Adjustment (calibration) unit.
GCOR coefficient	1	0.9 ÷ 1.1	Gravity correction factor (refer to section 15.4).
Reading unit - Range 1	0.001	0.0000001 ÷ 50	Reading units for Range 1.
Verification unit - Range 1	None	None, 0.001, 0.002, 0.005, 0.01, 0.02, 0.05, 0.1, 0.2, 0.5, 1, 2, 5, 10, 20, 50	Verification units for Range 1, 'none' value - unverified version.
Reading unit - Range 2	0.001	0.0000001 ÷ 50	Reading units for Range 2.
Verification unit - Range 2	None	None, 0.001, 0.002, 0.005, 0.01, 0.02, 0.05, 0.1, 0.2, 0.5, 1, 2, 5, 10, 20, 50	Verification units for Range 2, 'none' value - unverified version.
Digits marker	None	None, 1, 2, 3	Setting quantity of digits (counting from the last digit of the displayed result) over which a marker is to be displayed and printed out in case of unverified balances and scales.
Max range	3.009	-	Maximum range + overload.
Range 2 threshold	0.000	-	II range switching point. For single range weighing devices set 0.
External adjustment weight	3.000	-	External adjustment weight mass.
Autozero range	Predefined	Predefined, 0.1, 0.2, 0.25, 0.5, 0.6, 0.7, 0.8, 0.9, 1, 2, 2.5, 3, 4, 5, 6, 7, 8, 9, 10.	Autozero range [d]: Predefined - value taken from program-implemented tables; 0.1 ÷ 10 - value entered directly by a user.
Autozero range	Predefined	Predefined, 0.1, 0.2, 0.25, 0.5, 0.6, 0.7, 0.8, 0.9, 1, 2, 2.5, 3, 4, 5, 6, 7, 8, 9, 10.	Autozero range [d]: Predefined - value taken from program-implemented tables; 0.1 ÷ 10 - value entered directly by a user.
Autozero time	Predefined	Predefined, 0, 0.2, 0.4, 0.6, 0.8, 1, 2, 3, 4, 5, 6, 7, 8, 9, 10, 15, 20.	Autozero time [s]: Predefined - value taken from program-implemented tables; 0 ÷ 20 - value entered directly by a user.
Stability range	Predefined	Predefined, 0.1, 0.2, 0.25, 0.5, 0.6, 0.7, 0.8, 0.9, 1, 2, 2.5, 3, 4, 5, 6, 7, 8, 9, 10.	Stability range [d]: Predefined - value taken from program-implemented tables; 0.1 ÷ 10 - value entered directly by a user.

Stability time	Predefined	Predefined, 0, 0.2, 0.4, 0.6, 0.8, 1, 2, 3, 4, 5, 6, 7, 8, 9, 10, 15, 20.	Stability time [s]: Predefined - value taken from program-implemented tables; 0 ÷ 20 - value entered directly by a user.
Start mass control	YES	Yes, No, 50%, Definable.	Start mass control: YES – range: -10% to +10% of start mass, No – off, 50% – range: -50% to +50% of start mass, Definable – range declared in 'Start mass threshold' parameter.
Start mass threshold	10	10% ÷ 90%	Start mass value range in [%].
Adjustment	-	-	Weighing instrument adjustment menu
External Adjustment	-	-	Weighing instrument adjustment (refer to section. 15.2.1).
Start Mass Determination	-	-	Start mass determination (refer to section 15.2.2).
Start mass	100	-	Current start mass expressed in converter's divisions.
Adjustment factor	100	-	Current adjustment coefficient.
Factory start mass	100	-	Start mass value expressed in converter's divisions, read in the course of factory adjustment.
Factory adjustment factor	100	-	Adjustment factor value, determined in the course of factory adjustment.
Section linearity	-	-	Section linearity correction (refer to section 15.3).
Determine	-	-	Determining linearity correction points.
Corrections	-	-	Entering corrections for linearity correction points.
Delete	-	-	Deleting linearity correction.
Definable filter		 Inactive,  Active	Activating the filter and defining filter dynamics.
Restore default factory settings	-	-	Restoring default factory settings.

15.2. Factory Adjustment

15.2.1. External Adjustment

- Enter <Factory/Adjustment> submenu.
- Select <External adjustment> parameter. Message <Remove weight> is displayed.

- Unload the weighing pan and press  key to confirm.
- Message **<Adjustment. Please wait...>** is displayed.
- Upon completed start mass determination procedure, message **<Put weight xxx>** is displayed (where: xxx – adjustment weight mass).
- Load the weighing pan with required adjustment weight and press  key to confirm. Message **<Adjustment. Please wait...>** is displayed.
- Upon adjustment completion, message **<Remove weight>** is displayed.
- Take the weight off the weighing pan, the weighing device displays the **<Adjustment>** submenu.

15.2.2. Start Mass Determination



- Enter **<Factory/Adjustment>** submenu.
- Select **<Start mass determination>** parameter. Message **<Remove weight>** is displayed.
- Unload the weighing pan and press  key to confirm.
- Message **<Start mass determination. Please wait...>** is displayed.
- Upon completed determination process, the weighing device displays the **<Adjustment>** submenu.



15.3. Linearity Correction



15.3.1. Linearity Determination

Declaring masses for subsequent linearity steps and determining corrections by weighing instrument software.

Procedure:

- Enter **<Factory/Section linearity>** submenu and select **<Determine>** parameter. Message **<Continue?>** is displayed.
- Press  key to confirm. Edit box **<Mass>** is displayed.
- Unload the weighing pan.
- Enter the required mass value (first linearity correction point) and press  key to confirm. Message **<Put weight xxx>** is displayed (where: xxx – entered mass value).
- Load the weighing pan remembering that the load mass must equal weight value specified for the first linearity correction point (it is possible to preview the weighing result in the displayed window).



- Upon result stabilization, press  key to confirm. Edit box **<Mass>** is displayed again (second linearity correction point).
- Linearity correction process for the 2nd point is analogous to the linearity correction process for the 1st point.
- Upon declaring requested quantity of linearity correction points and upon display of the next edit box **<Mass>**, press  key.
- **<Section linearity>** submenu is displayed automatically.

	<p><i>Upon pressing  key in order to confirm zero value for linearity correction, message: <Value too low> is displayed.</i></p>
---	--

15.3.2. Corrections

Editing corrections values for particular linearity points.

Procedure:

- Enter **<Factory/Section linearity>** submenu.
- Select **<Corrections>** parameter. List of determined linearity correction points is displayed, the list contains previously declared masses, for particular correction points, and deviations, expressed in scale reading units.
- Select requested position, edit box **<Mass>** is displayed.
- Enter requested correction and/or press  key to confirm. Edit box **<Correction>** is displayed automatically.
- Enter requested correction and/or press  key to confirm. **<Corrections>** submenu is displayed automatically.

15.3.3. Deleting Linearity

- Enter **<Factory/Section linearity>** submenu.
- Select **<Delete>** parameter. Message **<Delete?>** is displayed.
- Press  key to confirm.

15.4. Gravitational Coefficient

The function of gravity correction compensates changes of gravity force being a result of different latitude. It allows correct scale adjustment away from the point of subsequent use. The value of gravity correction must be entered with reference to tables prepared by „RADWAG Wagi Elektroniczne” or calculated using the below formula:

$$G_{cor} = \frac{g_{uzyt.}}{g_{kal.}}$$

Correction value ranges between 0.90000 ÷ 1.99999.

	<p><i>If the weighing instrument is calibrated in the place of use, then the value of <GCOR coefficient> parameter must be 1.00000. If the scale is calibrated far from the place of use (longitudinal change) the value must be corrected.</i></p>
---	--

16. CONNECTION CABLES LIST

PT0327: scale – IM01 cable.

PT0328: scale – RS485 cable.

PT0329: scale – RS232 cable.

17. STANDARDS LIST

The device is manufactured in accordance with the following standards:

1. EN 61326-1:2013 *Electrical equipment for measurement, control and laboratory use - EMC requirements - Part 1: General requirements.*
2. EN 61010-1:2010 *Safety requirements for electrical equipment for measurement, control and laboratory use - Part 1: General requirements.*
3. EN 60079-0:2012 + A11:2013 *Explosive atmospheres - Part 0: Equipment - General requirements.*
4. EN 60079-11:2012 *Explosive atmospheres - Part 11: Equipment protection by intrinsic safety "i".*
5. EN 60529:1991 + A2:2013 *Degrees of protection provided by enclosures (IP Code).*



RADWAG BALANCES AND SCALES
ADVANCED WEIGHING TECHNOLOGIES

