

5Y-series comparators

5Y PM.KB Mass Comparator

USER MANUAL

IMKO-1112-01-06-23-PL



www.radwag.pl

Thank you for choosing and purchasing the RADWAG comparator. The comparator has been designed and manufactured to serve you for many years. Please read this manual to ensure its reliable operation.

JUNE 2023

Contents

1. BASIC INFORMATION	7
1.1. Intended use	7
1.2. Precautions	7
1.3. Terms of guarantee	7
1.4. Supervision of metrological parameters of the mass comparator	8
1.5. Information in the manual	8
1.6. Staff training	8
2. TRANSPORTATION AND STORAGE	8
2.1. Delivery inspection	8
2.2. Packaging	8
3. UNPACKING AND INSTALLATION.....	8
3.1. Installation place, place of use	8
3.2. List of standard delivery elements	8
3.3. Description of ports	9
3.4. Unpacking	9
3.4. Mass comparator cleaning	10
3.6. Connection to the network	12
3.7. Mass comparator temperature stabilisation time.	12
3.8. Connection of additional equipment.....	12
4. ACTIVATION OF THE MASS COMPARATOR	13
5. PROGRAM STRUCTURE.....	14
6. PROGRAM WEIGHING WINDOW	15
7. LOGIN.....	16
8. NAVIGATION IN THE MASS COMPARATOR MENU.....	17
8.1. Balance keyboard.....	17
8.2. Voice commands.....	17
8.3. Return to weighing function.....	18
9. COMPARISON	19
9.1. Selection of comparison unit.....	19
9.2. <i>Principles of correct comparison</i>	19
9.3. Mass comparator levelling	20
9.4. <i>Mass comparator zeroing</i>	20
9.5. Mass comparator tarring	20
9.6. Working mode activation procedure.....	21
9.7. Parameters related to working mode	22
9.8. Quick-access keys, proximity sensors	22
9.8.1. Proximity sensors	24
9.9. Working mode - Comparator	24
9.10. Selection of the measurement method in the mass comparator	25
9.11. Declaration of the number of cycles.....	26
9.12. Declaration of the number of test run cycles.....	26
9.13. Start delay	26
9.14. Tare mode	26
9.15. Automatic printout of the footer/C-label.....	26

9.16.	Printout / approval mode	27
9.17.	Printouts	28
9.18.	Report on previous comparison processes	30
9.19.	Management of information in the screen.....	31
9.20.	Comparison – basic procedure	31
10.	CALIBRATION	33
10.1.	Internal calibration	33
10.2.	External calibration	33
10.3.	Operator’s calibration	33
10.4.	Calibration test	34
10.5.	Automatic calibration	34
10.6.	Automatic calibration time.....	34
10.7.	Report printout	34
10.8.	GLP template.....	34
10.9.	Calibration history	35
11.	ADMINISTRATOR PANEL	35
11.1.	Password settings	36
11.2.	Operator’s accounts setting	36
11.3.	Permission management	37
11.4.	Remote access password	38
12.	PROFILES.....	39
12.1.	Profile creation.....	39
12.2.	Profile structure	40
12.2.1.	Settings	41
12.2.2.	Working modes.....	41
12.2.3.	Readout	41
12.2.4.	Units.....	43
13.	DATABASES.....	44
13.1.	Operations in databases.....	44
13.2.	Operators.....	45
13.3.	Products	50
13.4.	Customers.....	51
13.5.	Reference weights	51
13.6.	Test weights.....	52
13.7.	Comparison plans.....	52
13.8.	Packaging	53
13.9.	Warehouses	53
13.10.	Printouts	53
13.11.	Universal variables	56
13.12.	Databases management.....	56
14.	REPORTS.....	56
14.1.	Operations in databases.....	56
14.2.	Weighing records	57
14.3.	Comparison reports	57
14.4.	Weight adjustment reports	58
14.5.	Environmental conditions	58
14.6.	Reports management	58
14.6.1.	Export weighing base to file.....	59

14.6.2.	Delete weighing records and reports	60
15.	COMMUNICATION	61
15.1.	RS 232 ports settings	61
15.2.	ETHERNET port settings	62
15.3.	Wi-Fi port settings.....	62
15.3.1.	General information on Hot Spot service	63
15.3.2.	Activation of Hot Spot service	64
15.4.	TCP protocol settings	66
15.5.	Virtual COM Settings	67
16.	DEVICES	67
16.1.	Computer.....	67
16.1.1.	Computer port	67
16.1.2.	USB Free Link	67
16.1.3.	Computer address	68
16.1.4.	Continuous transmission	68
16.1.5.	Interval.....	69
16.1.6.	Weighing printout template	69
16.1.7.	Cooperation with E2R System	69
16.2.	Printer	70
16.3.	Barcode scanner	72
16.3.1.	Barcode scanner port.....	72
16.3.2.	Prefix / Suffix.....	73
16.3.3.	Field selection	73
16.3.4.	Test.....	74
16.4.	Environmental module	74
16.5.	IM02 communication module	74
16.5.1.	Activation of IM02-to-scale connection	75
17.	INPUTS / OUTPUTS.....	75
17.1.	Input Setup.....	75
17.2.	Output Setup.....	75
18.	OTHER PARAMETERS.....	77
18.1.	Interface language selection	77
18.2.	Date and time settings.....	77
18.3.	Extension module.....	79
18.4.	Sound.....	79
18.5.	Visual result approval	79
18.6.	Screen saving	79
18.7.	Screen brightness	80
18.8.	Vibration detection	80
18.9.	Level control.....	80
18.10.	Decimal point	81
18.11.	Sensors sensitivity	81
18.12.	Door opening.....	81
18.13.	Automatic ionisation	81
18.14.	Autotest.....	82
18.15.	Start-up logo	85
18.16.	System events export.....	85
18.17.	Text-to-speech conversion	85
19.	SCHEDULED TASKS	86

19.1.	Balance calibration	86
19.2.	Message.....	87
20.	ENVIRONMENT.....	89
21.	UPDATE.....	89
22.	SYSTEM INFO.....	90
23.	COMMUNICATION PROTOCOL	90
23.1.	Manual printout/automatic printout	91
24.	CONNECTION OF PERIPHERALS	91
25.	ERROR MESSAGES.....	92
26.	ADDITIONAL EQUIPMENT	92
29.	APPENDIX B – Programmable Buttons List	93

1. BASIC INFORMATION

1.1. Intended use

5Y-series mass comparators are intended to determine mass difference between the reference weight (A) and test weight (B).

Mass comparators are usually used in weight calibration laboratories and national metrology institutes.

1.2. Precautions

- Before you start using the device, please read this Operating Manual carefully and use the product as designed.
- Do not use sharp tools (e.g. knife, screwdriver, etc.) to operate the touch panel.
- The weights that you compare must be carefully positioned in the central part of a weighing pan of the mass comparator.
- Load the weighing pan with weights whose gross mass is lower than the maximum loading capacity of the mass comparator.
- In case of failure, immediately disconnect the comparator from the power supply.
- The device that is to be withdrawn from service must be disposed of in accordance with currently applicable rules of law.
- Do not use the comparator in the explosive atmosphere. The comparator is not intended for use in hazardous areas.

1.3. Terms of guarantee

- A. RADWAG undertakes to repair or replace the components that prove defective in terms of manufacture or design.
- B. Specification of defects of unclear origin and determination of elimination methods can only be done in cooperation with representatives of the manufacturer and operator.
- C. RADWAG does not take responsibility for any damage or loss arising from unauthorised or wrong performance of production or servicing processes.
- D. The guarantee does not cover the following:
 - mechanical damage arising from wrong operation of the mass comparator as well as thermal, chemical damage, or damage caused by atmospheric discharge, overvoltage in the power network or other random event,
 - damage to the mass comparator, when used at variance with intended use,
 - damage to the mass comparator when the service centre declares violation or damage to the mark that secures structure of the mass comparator against opening,
 - damage caused by liquids and natural wear,
 - damage to the mass comparator due to wrong adaptation or power network defects,
 - damage arising from measuring mechanism overloading,
 - maintenance works (mass comparator cleaning works).
- E. The guarantee cover is lost when:
 - repair is entrusted to an unauthorised service centre,
 - the service centre finds interference of unauthorised people into mechanical or electronic structure of the mass comparator,
 - other version of the operating system is installed,
 - the mass comparator does not have company securing marks,
- F. Detailed terms of the guarantee can be accessed in the maintenance sheet.

1.4. Supervision of metrological parameters of the mass comparator

Metrological properties of the mass comparator must be checked by the operator at pre-arranged fixed intervals. Frequency of checking is determined by factors of the environment which the mass comparator works in, types of comparison processes as well as the quality of supervision system.

1.5. Information in the manual

Carefully read the operating manual before you plug in and switch on the mass comparator, even you are experienced in working with such devices. The manual includes all information required for suitable use; adherence to guidelines showed in the manual is a guarantee of proper and reliable work of the mass comparator.

1.6. Staff training

The mass comparator must be used and supervised only by people trained on its use and experienced in using such devices.

2. TRANSPORTATION AND STORAGE

2.1. Delivery inspection

Inspect the packaging and device for any signs of exterior damage immediately after the delivery. If you can find any damage, contact the manufacturer's representative.

2.2. Packaging

Please keep all elements of the packaging in order to use them in case it is potentially necessary to transport the mass comparator in the future. Only the original packaging of the mass comparator can be used for shipping. Before you pack the product, disconnect all cables and remove moving parts (weighing pan, covers, inserts). Put all elements of the mass comparator into the original box and secure against transport damage.

3. UNPACKING AND INSTALLATION

3.1. Installation place, place of use

- Store and use the mass comparator in rooms that are free from vibrations and shocks, and free from draughts and dust.
- The room temperature must range from +15 °C to +30 °C and its fluctuations must not exceed 0,5°C/12h.
- The relative humidity must range from 40% to 60% and its fluctuations must not exceed 2%/4h.
- The mass comparator must be positioned on a wall bracket or stable table that is not subject to vibrations, away from sources of heat.
- Special attention must be paid to magnetic properties of test weights as a strong magnet is a part of the mass comparator. Their magnetic power must be zero.

3.2. List of standard delivery elements

- Mass comparator
- Weighing pan
- Weighing indicator
- Anti-draft chamber
- Power adapter

3.3. Description of ports

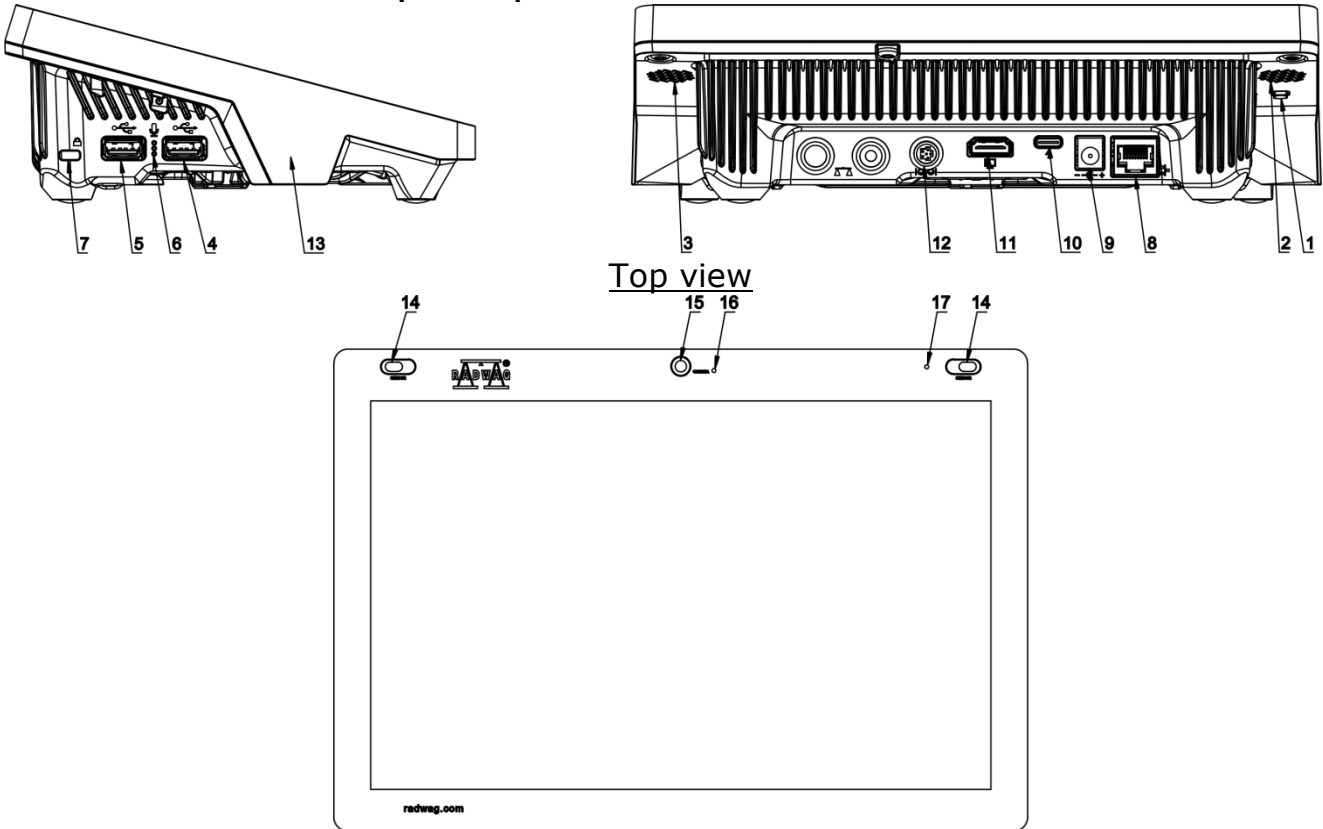

1	Hard reset or OFF-ON key	10	Power port - USB-C
2	Left loudspeaker	11	HDMI port
3	Right loudspeaker	12	Media box port
4	USB-A port	13	RFID sensor
5	USB-A port	14	Reflective sensors
6	Microphone	15	Camera
7	Kensington Lock	16	Camera LED light
8	Ethernet port	17	Signalling light
9	Power port		

3.4. Unpacking

Slash a protective tape. Take the mass comparator out of the factory box. Take all elements of the device out of accessories box.

Before you start installing the mass comparator, read the manual carefully in order to properly prepare the device for operation, as per steps described in the document.

Note:

All steps must be taken carefully and gently in order not to damage the mass comparator mechanism.

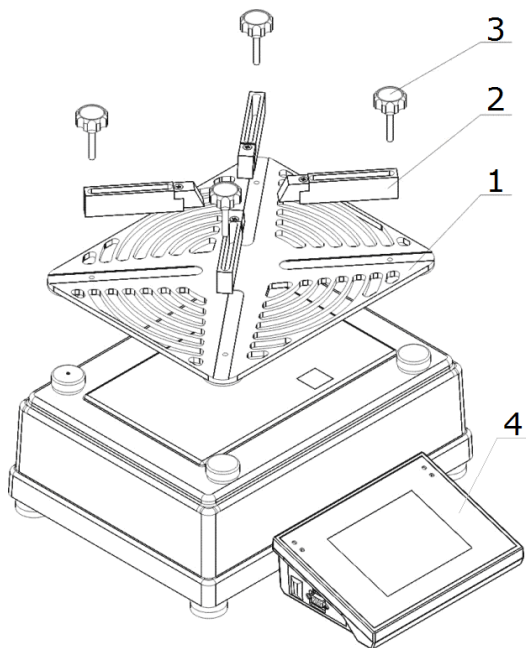

After placing the comparator in the place of use, do as follows:

1. Put the weighing pan on (1).
2. Fix 4 handles (2) and screw them (3) to the weighing pan (use screws).

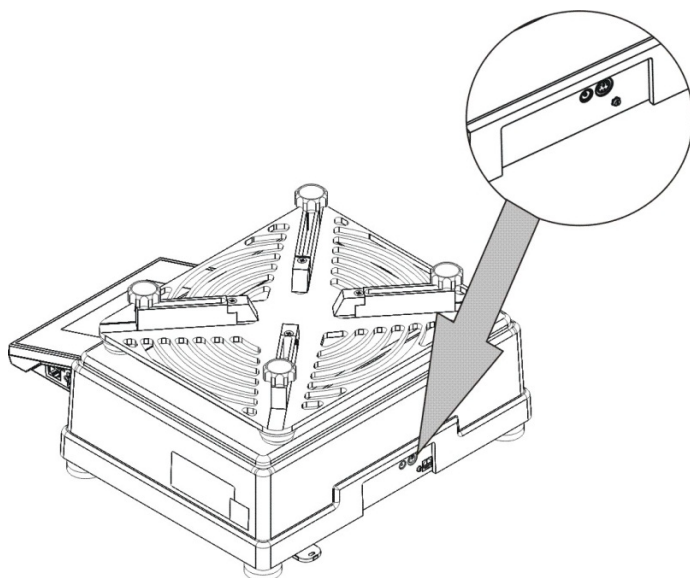

3. Connect the head (4) to the port at the back of the balance
4. Connect the AC power adapter.

3.4. Mass comparator cleaning

Note:

If you clean the weighing pan after it has been installed, you may damage the mass comparator.

1. Disassemble the weighing pan and other moving pieces of the mass comparator. Be careful when taking these actions in order not to damage the mass comparator mechanism.
2. Use a small keyboard cleaner to remove dust from the weighing chamber, as far as possible.

Glass elements cleaning:

Depending on the type of dirt, a suitable solvent must be chosen. Never immerse glass in strong alkaline solutions as it may get damaged under their influence. It is forbidden to use abrasive agents.

In case of any organic residues, use acetone. You can use water and detergent in another step. In case of non-organic residues, use diluted acid solutions (soluble salts of the hydrochloric acid or nitric acid) or bases (mostly sodium base, ammonium base).

ACIDS are removed with basic solvents (sodium carbonate), while BASES with acid solvents (mineral acids of various concentration).

In case of stubborn dirt, use a brush and detergent. Avoid detergents whose molecules are large and hard and likely to scratch the glass.

To finish with, carefully rinse the glass with distilled water.

Always use soft brushes with a wooden or plastic grip to avoid scratching. Do not use wire brushes or brushes with a wire core.

Rinsing is necessary to make sure all residues of soap, detergents and other cleaning agents are removed from the glass produce before their are reinstalled on the balance.

After initial cleaning, glass elements must be washed under running water, and distilled water at the end.

It is not advisable to dry the glass with a paper towel or under a stream of forced air because it may supply the glass elements with fibres or other dirt, and eventually result in wrong weighing indication.

Do not use electric driers for measuring glassware.

After washing, glass elements are usually put on the shelf for drying.

Powder-coated elements cleaning

The first step must be to clean with a slightly wetted large-pore sponge to remove loose and major dirt.

Do not use abrasive agents.

If that proves insufficient, use a suitable cloth and water-cleaning agent solution (soap, dishwashing liquid) to clean the surface. When doing so, apply a regular pressure of the cloth against the surface.

Never dry clean with a detergent itself as it may damage the coating – use a large amount of water or water-cleaning agent solution.

Aluminium elements cleaning

To clean aluminium, use products that contain natural acids. Feel free to choose distilled vinegar or lemon. It is forbidden to use abrasive agents. Avoid rough brushes as they may easily scratch the aluminium surface. A soft microfibre cloth will be the best choice.

While cleaning polished surfaces, make circular movements. After removing dirt, polish the surface with a dry cloth to dry it off and make it glow.

Stainless steel elements cleaning:

While cleaning stainless steel elements, follow the table below. The table shows types of pollution and pollutant elimination methods.

Fingerprints	Wash with a spirit or solvent. Wash with pure water and wipe it dry.
Oils, fats, greases	Wash with organic solvents and then with warm water and soap or soft detergent. Rinse with pure water and wipe it dry.

Stains and temperature decomposition	Wash with a soft scrubbing detergent. Gently clean as per the direction of the surface structure. Rinse with pure water and wipe it dry.
Strong discolouration	Gently clean as per direction of the surface structure. Rinse with pure water and wipe it dry.
Traces of rust	Moisten with an oxalic acid solution and leave for about 15-20 minutes. Next wash with warm water and soap or soft detergent. Rinse with pure water and wipe it dry.
Paints	Wash with a paint solvent, and then with warm water and soap or soft detergent. Rinse with pure water and wipe it dry.
Scratches on the surface	Gently polish with an unwoven fabric (iron-free) as per direction of the surface structure. Then wash with soft scrubbing detergent. Rinse with pure water and wipe it dry.

ABS elements cleaning:

To clean dry surfaces, it is necessary to use clean cellulose or cotton cloths that do not leave streaks and do not dye. You can also use a solution based on water and cleaning agent (soap, dishwashing liquid, window washing agent). While cleaning the surface, apply a regular pressure of the cloth against the surface. Wipe the surface in question and dry it off. Cleaning can be repeated, if necessary.

In case of hard-to-remove dirt, such as residues of glue, tar, polyurethane foam, etc., you can use special cleaning agents based on mixture of aliphatic hydrocarbons that does not dissolve materials. Before you use the cleaning agent, it is advisable to perform usability tests covering all surfaces. Do not use abrasive agents.

3.6. Connection to the network

The mass comparator can be connected to the network only with the use of the original power adapter (supplied). The rated voltage of the power adapter (given on its rated plate) must comply with the rated voltage of the network.

To power the mass comparator, insert the power adapter into the mains socket while the pin of the power adapter into the port located at the back of the mass comparator housing.

3.7. Mass comparator temperature stabilisation time.

Before you initiate measuring, wait for the mass comparator to stabilise thermally.

With regard to mass comparators that before connection to the network were stored at a substantially lower temperature (e.g. in winter), the acclimatisation and heating time is about 12 hours. While the mass comparator is stabilising thermally, the indication displayed may change. It is advisable to make sure the potential surrounding temperature fluctuations are minor and slow in the place of using the mass comparator.

3.8. Connection of additional equipment

Only the additional equipment that is recommended by the mass comparator manufacturer can be connected. Before you connect the additional equipment or change the aforesaid equipment (e.g. printer, PC, USB-type computer keyboard or additional display unit), unplug the comparator. After connecting devices, repower the comparator.

4. ACTIVATION OF THE MASS COMPARATOR

- Supply power to the balance.

NOTE: The balance is equipped with two ports for a power adapter. One port is located in the readout head, and the other at the back of the weighing mechanism housing. The balance can be supplied with power from both the head and balance mechanism, but it is forbidden to do it from both at a time, with the use of two power adapters. Otherwise you may damage the balance and power adapters.

- After a while the operating system and RADWAG software will start loading. The start-up procedure will be accompanied by a flashing signalling light and LED lights at the lower frontal part of the readout head.
- Once the start-up procedure has ended, a home screen will automatically open in other balances.
- The balance activates with the unlogged operator (no user) to initiate operation. You must log in (login procedure will be described further in the manual).



Note: *The balance must be activated without any load – with an empty weighing pan.*

In the case of verified balances, as per provisions of EN 45501 standard, the mass value displayed must not be below -20e. Therefore, if the value is lower than the aforesaid value, the main display shows: <Lo mass>.



If this is the case, zero the balance by pressing

If the program crashes during operation, perform the so-called hard reset. To do so, press the balance head button and keep it pressed for about 5 seconds. The program will restart and the device will reactivate.

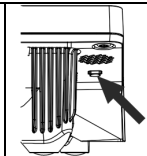

5. PROGRAM STRUCTURE

The main menu of the program has been divided into functional groups. Each group includes parameters grouped by themes. The description of each group can be found further in the manual.

List of menu groups - Parameters

To gain access to the main menu, press the key in the lower bar of the screen - .

The menu includes parameters related to balance settings, functions and profiles.

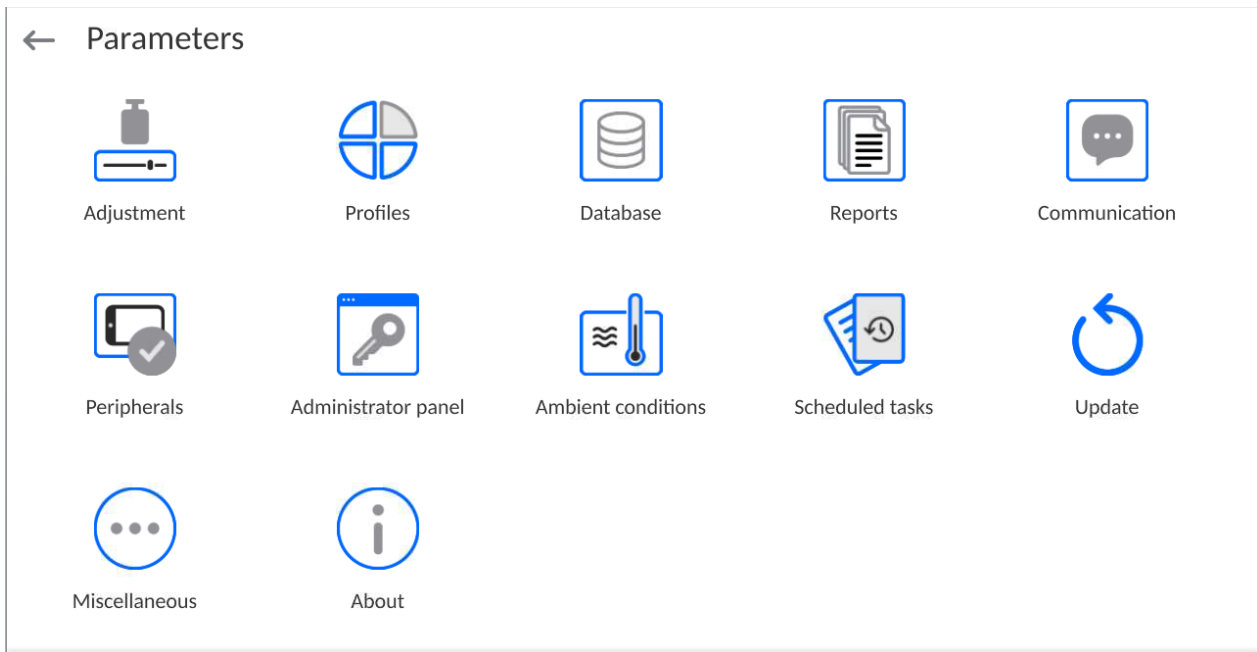

6. PROGRAM WEIGHING WINDOW

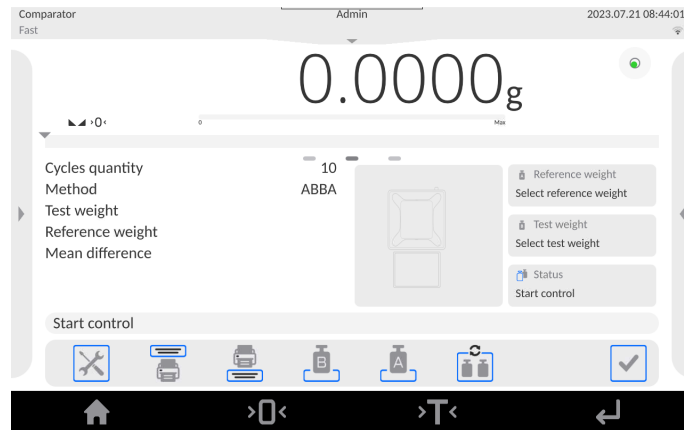

The home screen of the application can be divided into 5 fields:

- The upper part of the screen shows information on a currently used working mode, logged user, date, time, active connection to PC.



- Below is a window that shows the weighing result and balance levelling status.



- The field contains additional information related to current activities.

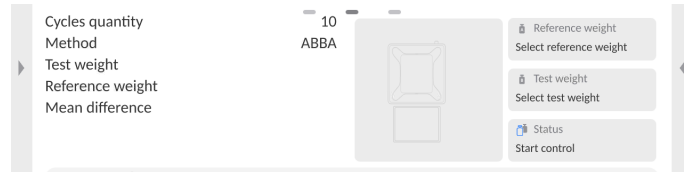

Note:

The information included in this field is freely programmable. The way of defining will be described further in the manual.

- The on-screen functional keys are presented below:



Note:

The balance operator is allowed to define on-screen functional keys. The way of defining will be described further in the manual.

- Fixed functional keys can be found at the bottom of the screen:



7. LOGIN

In order to gain full access to user parameters and database edition, the balance operator must log in as **<Administrator>**.

To do so, expand the menu in the upper part of the screen.

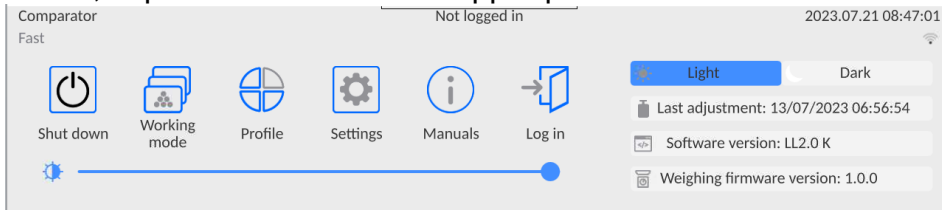

First login:

- After you have expanded the top menu, press the field with **<Log in>** inscription. The operator base window with **<Admin>** item will pop up.

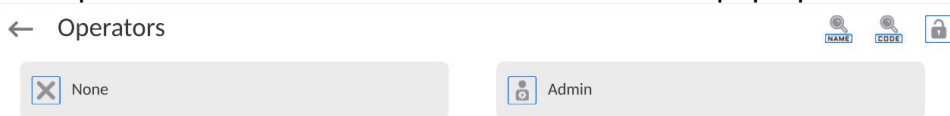

- By default this operator is not assigned any access password. If you select it, the program home screen will be automatically displayed.

NOTE: After the first logging, at first enter operators and assign them relevant permission levels and unique access passwords (procedures will be described further in the manual, see point 11 and 13.2).

During another login, select the operator from the list, enter the password to make the program work for the specific operator as per its permission level.

Logout:

- Expand the menu in the upper part of the screen and press the field with **<Log in>**.
- After collapsing the top menu in the upper bar of the screen, the logged operator's name will turn into **<Not logged in>**.

8. NAVIGATION IN THE MASS COMPARATOR MENU

It is very intuitive and easy to navigate in the menu of the weighing program. Thanks to the display with a touch panel, you can easily use the program. When you press the on-screen button or field in the screen, you activate the assigned operation or function.

8.1. Balance keyboard

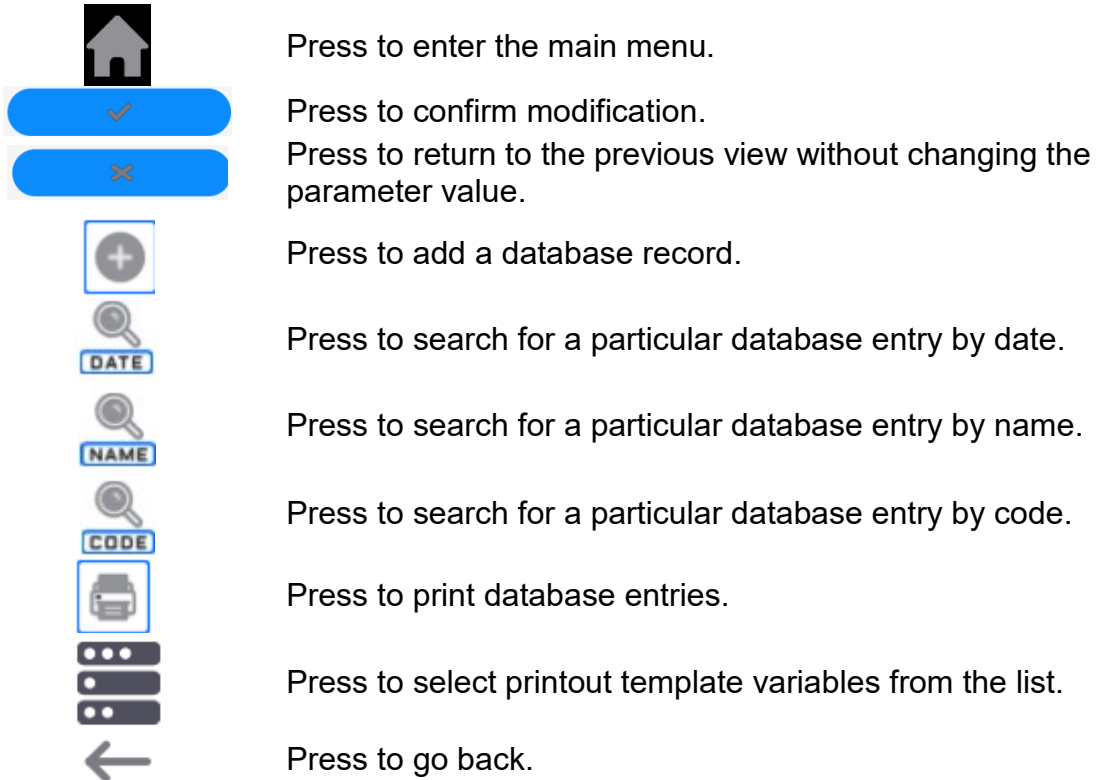

8.2. Voice commands

The balance program allows performing several operations via voice commands. These are the following operations: tarring, zeroing, print/save measurement. The commands must be expressed in English, in a suitable sequence. See below for the structure of particular commands.

Tarring: **ellipsis** [please] (tare | tar | terre) [the] device

Zeroing: **ellipsis** [please] zero [the] device

Print/Save: **ellipsis** [please] save [the] (mass | measurement | mass measurement)

The method of expressing the command: black text is obligatory, green text may be expressed but does not need to, red text – one of them must be obligatorily expressed e.g.: for the Print command: **ellipsis save mass**.

Procedure:

1. Place the  voice command activation key on the button bar (the method of adding buttons is described further in the manual).

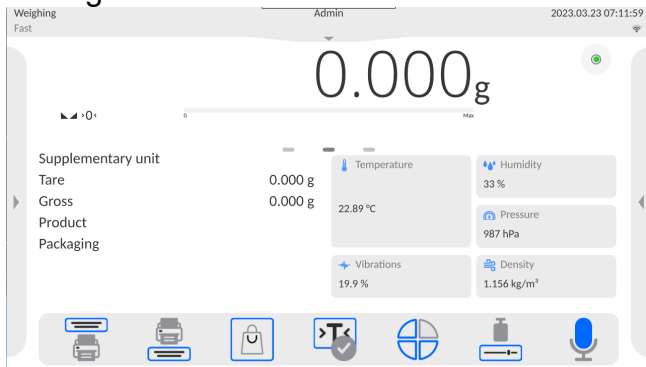

2. Press  button.
3. The voice command recognition procedure will be initiated and the operator will be informed about it through messages.

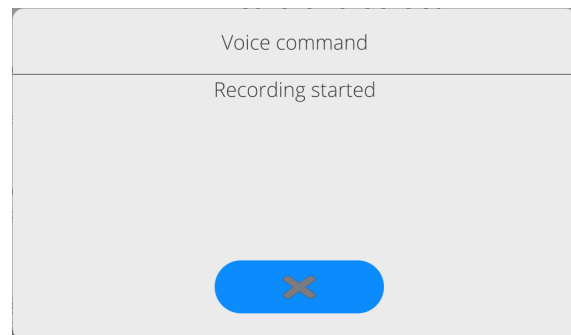
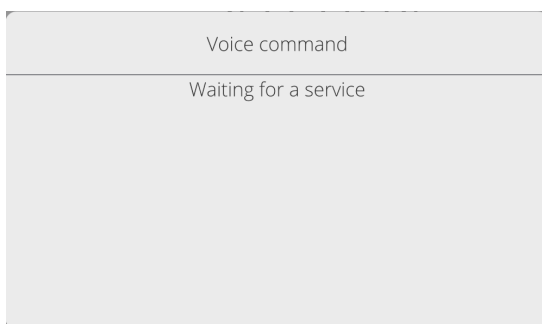

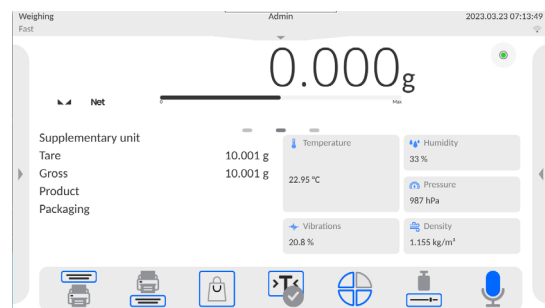
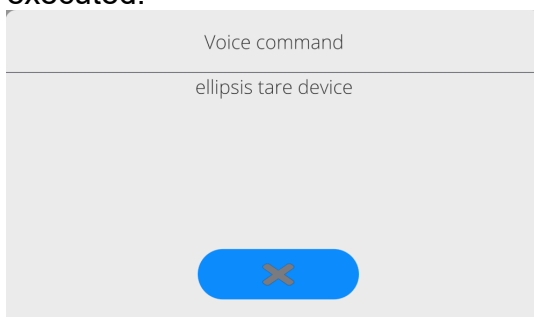

4. Express the command as per the description above.
5. If the command is expressed correctly and the program can recognise the command, a message will be displayed and the command will be automatically executed.



8.3. Return to weighing function

Any changes entered into the balance memory are automatically saved in the menu after returning to the home screen.

Procedure:

- Press  button a couple of times to return to the main screen of the balance.
- Press  field in the upper bar to return to the home screen instantly.

9. COMPARISON

Place the test weight on the weighing pan of the mass comparator. When  marker is displayed on the left side of the screen, you can read the weighing result.

You can save/print the weighing record out by pressing <PRINT> key:

- in verified mass comparators – only stable weighing result ( marker)

9.1. Selection of comparison unit

It is possible to change the comparison unit by pressing the unit displayed in the weighing window, just next to the measurement result. Click the unit to display a list of available units. Select any of the units to make the program automatically recalculate the value of the unit you have chosen.

Selection variants:

<i>unit</i>	<i>designatio n</i>	<i>verified comparator</i>	<i>unit</i>	<i>designation</i>	<i>verified comparator</i>
gram	[g]	yes	Taele Hongkong	[tlh]	no
milligram	[mg]	yes*	Taele Singapur	[tls]	no
			Taele Tajwan	[ttt]	no
carat	[ct]	yes*	Taele Chiny	[tlc]	no
pound	[lb]	no	Momme	[mom]	no
ounce	[oz]	no	Grain	[gr]	no
troy ounce	[ozt]	no	Newton	[N]	no
pennyweight	[dwt]	no	Tical	[ti]	no

* - Units available depending on the type of mass comparator.

In non-verified mass comparators, all units out of the International System of Units (SI) are available.

9.2. Principles of correct comparison

To guarantee a long-term use and correct measurements of masses of compared weights, please do as follows:

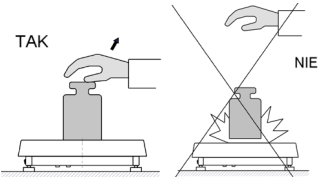
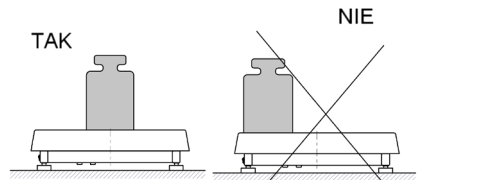
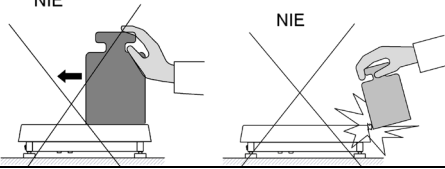

- Activate the mass comparator without any loads on the weighing pan of the mass comparator

	
<p>Load the weighing pan of the mass comparator calmly and without impact</p>	<p>Place loads on the weighing pan in a central position</p>
	
<p>Avoid side loading of the weighing pan, especially side strokes</p>	

9.3. Mass comparator levelling

The mass comparator has been equipped with the AutoLEVEL system that allows monitoring the mass comparator level. Thanks to this solution, you can continuously keep track of the mass comparator level while it is operating, which is signalled in the top right corner of the screen. In case the level changes, the system informs you about it in the display: by changing the position of the level indicator and/or by sounding the alarm and showing the mass comparator level setting window.



Mass comparator levelling procedure:

- Press <  > levelling icon in the top right corner of the screen.
- The display of the balance will show the levelling control panel.
- Level the balance by turning its legs in the way showed in the screen with pulsing pictograms <  > – level point will move towards the centre of the circle.
- When the point gets into the inner circle of the 'level view', its colour will change from red into green  – the balance has been levelled correctly.



Note:

The balance is equipped with the Automatic Level Control unit. You can see how it works further in the manual.

9.4. Mass comparator zeroing

In order to zero the mass value, press  button. The screen will show the zero value of the mass, together with the following symbols: $\pm 0 \pm$ and . Zeroing is tantamount to determination of a new zero point which is treated by the mass comparator as zero. Zeroing is possible only when the screen values are stable and when the weighing pan is loaded.

9.5. Mass comparator tarring



In order to determine the net mass, put the load box and wait for the readout to stabilise – then press  button. The screen will show a zero value in the mass field, together with the following symbols: **Net** and . After you take the load and box away, the screen will show the total value of tarred masses with a minus sign. You can also assign the tare value to the product in the database. If you do so, the mass comparator will collect the information on the tare from the base automatically, when you select a product.

Note:

*It is impossible to tare the negative value. An attempt to tare the negative value will cause the **Err3** error message to pop up. This being the case, zero the mass comparator and tare again.*

Manual tarring

Procedure:

- Press the quick-access button -  - in any working mode.
- A numerical keyboard will be displayed.
- Enter tare and press .
- The comparator will return to the comparison mode and the screen will show the tare value with 't'.

Tare deleting

You can delete the tare showed in the screen by pressing the ZERO key in the mass comparator housing or by using <Disable tare> programmable key.



Procedure 1 – after removing the tarred load from the weighing pan:

- press the ZERO key,
- NET marker will be deleted, a new zero point of the mass comparator has been determined.

Procedure 2 – when the tarred load is on the weighing pan:

- press the ZERO key,
- NET marker will be deleted, a new zero point of the mass comparator has been determined.
- when the tare value is higher than 2% of the maximum load, the screen will show the following message: Err- (operation unfeasible).

Procedure 3 – when the tarred load is on the weighing pan or after removing the tarred load from the weighing pan:

- press <Disable tare> programmable key ,
- NET marker will be deleted,
- the screen will show the tare value,
- press <Restore tare>  key to restore the recently used tare value.

9.6. Working mode activation procedure

To change the working mode:

- Expand the menu in the upper part of the screen.

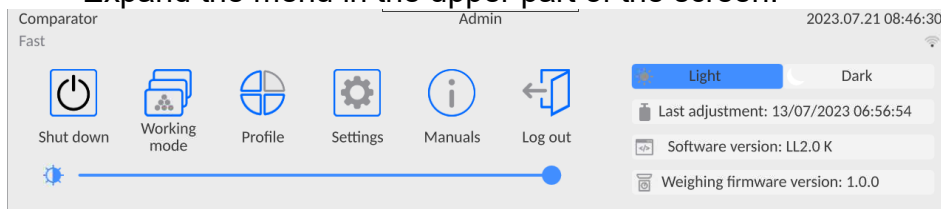

- Press <Working mode> item
- The screen will show a list of modes.
- Select the name of the mode that is to be used, and the balance will automatically activate the mode you have chosen.

9.7. Parameters related to working mode

Every working mode is related to programmable parameters that determine its operation. How to access these parameters:

1. Expand the left side menu.

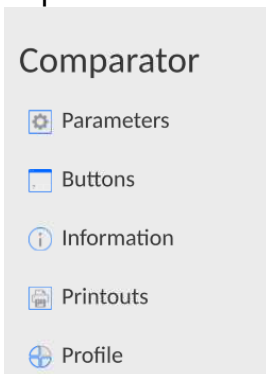

2. The following menu will be showed in the screen:
 - <Settings> - additional options related to the mode.
 - <Keys> - defining quick-access keys.
 - <Information> - selection of information to be showed in the Info field.
 - <Printouts> - selection of the type and content of printout.
 - <Profile> - settings for the profile
3. Press a relevant menu and select the element to be modified.

The description of basic parameters that are in the <Settings> menu can be accessed in the point 13.7 *Additional parameters related to weighing*. Other parameters related to specific modes are described under presentation of these modes.

9.8. Quick-access keys, proximity sensors

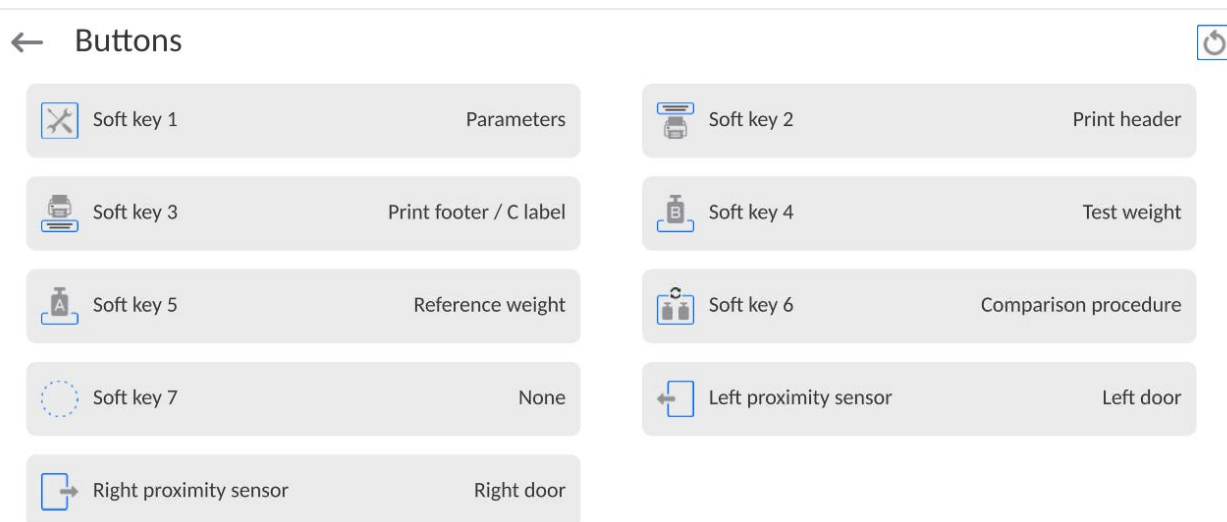

The operator can quickly return to the default arrangement of keys in the lower bar of the screen by pressing  key in the top right corner of the window.

The operator can define 7 keys that can be visible in the lower bar of the screen. Assignment of the function to the key causes a relevant icon to show up. The icon is displayed in the lower navigation bar of the home screen. Availability of keys depends on the

working mode. The list of keys can be accessed in the SUPPLEMENT B to the manual. It is the so-called quick-access key for the most frequent operations. Each working mode is assigned a default arrangement of keys. To quickly restore the default arrangement, you need to select <Default key arrangement> function. Another way of adding or changing the key is to press the field in the key bar and keep it pressed for about 3 seconds.

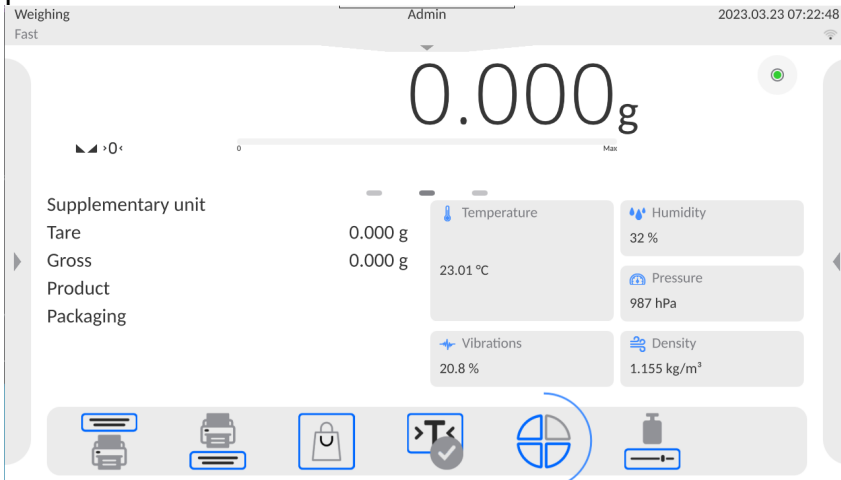

The program will display the window with the following keys automatically.

← Available actions

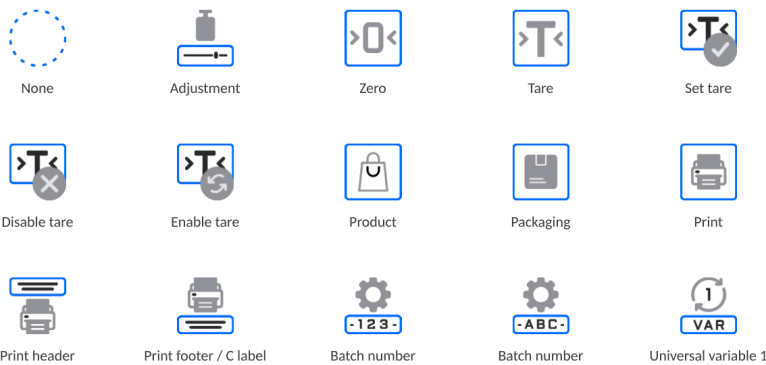

Press the key that is to be added and the program will display the home screen again. The key you have selected will appear in the place of activation.

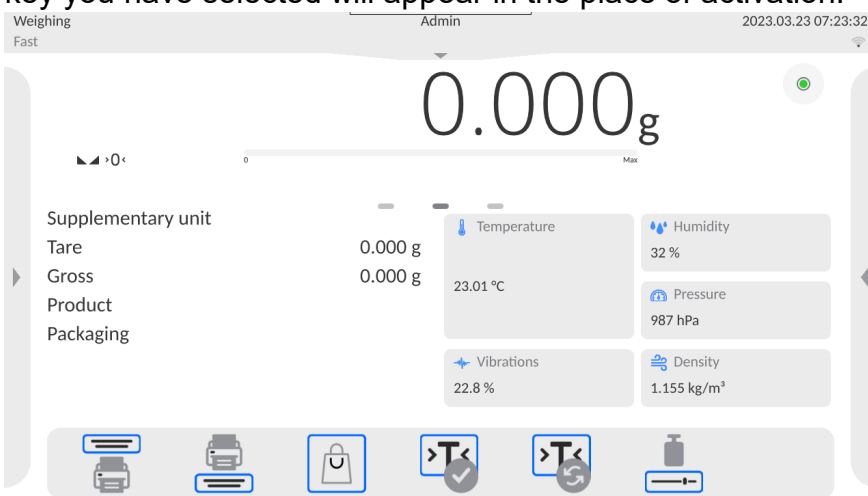

Note: The operator can gain access to the operating manual saved in the balance memory.

To use this function, set  help key in the key bar.

9.8.1. Proximity sensors

The balance is equipped with two proximity sensors that allow controlling the operation of the balance with no need to press buttons on the housing or touch screen.

The program can recognise four motions near sensors:

1. Putting the hand close to the left sensor <Left proximity sensor>.
2. Putting the hand close to the right sensor <Right proximity sensor>.

9.9. Working mode - Comparator

The <Comparator> working mode lets the operator determine standard deviation for a series of measurements. The standard deviation is determined on the basis of a series of ABBA, ABA or AB measurements, where:

A – control mass standard (reference weight)

B – test mass weight

The number of measurements for the series and ABBA, ABA or AB method is set by the operator in <Working Modes> parameters group in <Comparator> submenu.

Results are calculated by the program as per the tables and equations below:

For ABBA series

Item	A	B	B	A	$D = B_{sr} - A_{sr}$
1					D_1
2					D_2
3					D_3
4					D_4
5					D_5
.....					...
n					D_n

For ABA series

Item	A	B	A	$D = B - A_{sr}$
1				D_1
2				D_2
3				D_3
4				D_4
5				D_5
.....				...
n				D_n

For AB series

Item	A	B	$D = B - A$
1			D_1
2			D_2
3			D_3
4			D_4
5			D_5
.....			...
n			D_n

The standard deviation is calculated subsequently by determining:

- differences of ABBA or ABA for each group of measurements:

$$D_i = \bar{B} - \bar{A}$$

- average value of difference of ABBA or ABA:

$$\overline{DX}_i = \frac{1}{n} \sum_{i=1}^n D_i$$

- Standard deviation:

$$s = \sqrt{\frac{1}{n} \sum_{i=1}^n (D_i - \overline{DX}_i)^2}$$

9.10. Selection of the measurement method in the mass comparator

The settings of the working modes of the mass comparator have special functions adapted to the customer's specific needs. The working modes can be configured in **<Working modes>** submenu. To gain access to **<Working modes>** submenu, expand the right side menu.

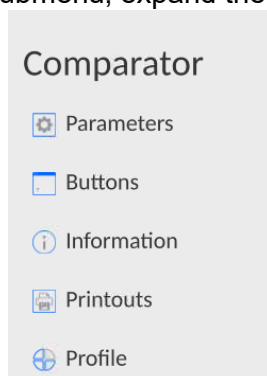

Next press **< Parameters >** key and the working mode edition box will be displayed:

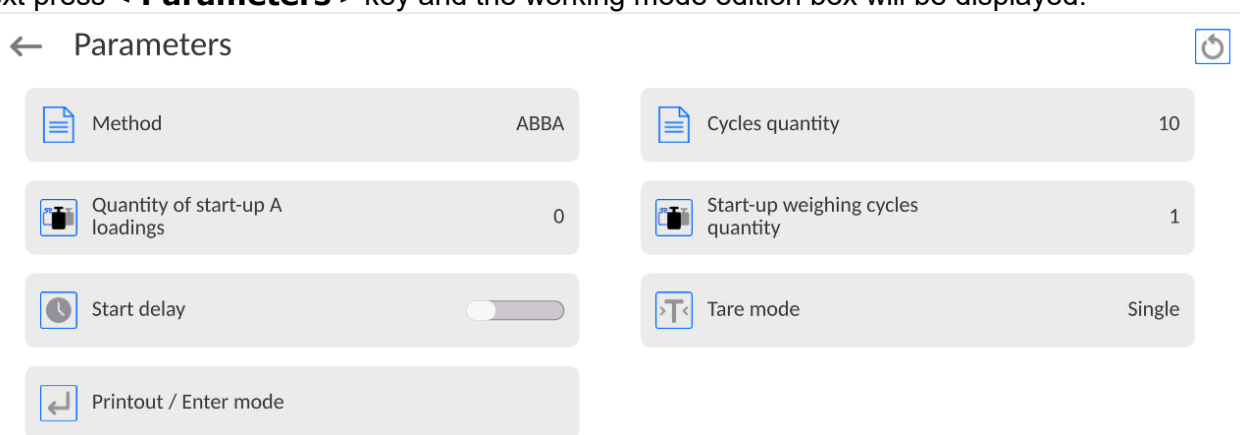

To change the type of weight calibration method, press **<Method>** key and select the desired method:

- ABBA
- ABA
- AB

9.11. Declaration of the number of cycles

Procedure:

- Select **<Comparator>** and press **<Parameters>**
- Press **<Number of cycles>** key and enter the desired number of measurement cycles, then press to approve.

9.12. Declaration of the number of test run cycles

Procedure:

- Enter **<Working Modes>** parameters group,
- Select: **<Comparator>**, then **< Parameters >** and **<Number of test run cycles>**. Then the **<Number of test run cycles>** edition box with the on-screen keyboard will be displayed.
- Enter the desired value and press
- key to confirm.

9.13. Start delay

- Enter **<Working Modes>** parameters group,
- Select: **<Comparator>**, then **< Parameters >** and **<Start delay>**. The setting selection edition window will be displayed afterwards,
- Enter: YES – when comparison starts, the window will be displayed. You need to enter the time by which the start is to be delayed. When the period of time has passed, the comparison procedure will be initiated automatically, NO – the procedure starts instantly after initiation. After selecting the relevant option, the selection window will be closed automatically and the description by the parameter will be modified.

9.14. Tare mode

Available options:

- **SINGLE:**
the value remembered after you press the TARE key once. If you press again, you set a new tare value. Selection of the product or box which the tare value is assigned to causes the previous tare to be deleted.
- **TOTAL OF CURRENT:**
summing up currently entered tare values for the product and box (arising from selection of the product and box from the database), with a possibility of adding the manually entered tare value to the total. After you set the tare value for the product or box again, the manually entered tare value will be disabled.
- **TOTAL OF ALL:**
summing up all subsequently entered tare values.
- **AUTOTARE:**
Principle of operation:
Every first measurement is tarred when the stable value is obtained. The screen will show the NET inscription and then you can specify the net mass. After removing the load and returning to the autozero zone, the program will delete the tare value automatically.
- **EVERY MEASUREMENT:**
possibility of tarring before every measurement in the series.

9.15. Automatic printout of the footer/C-label

Available options:

MODE – None – manual printout of the footer.

Total of measurements – the footer can only be printed out when the value of the mass entered in **<Threshold>** parameter is exceeded.

Number of measurements – the footer can only be printed out when the specific number of measurements (series) in <Threshold> parameter is made.

THRESHOLD – specification of the threshold value that determines printout of the footer.

For <Total of measurements> option, the value will be defined in the mass unit [g], and for <Number of measurements>, the value will be unnamed, specifying the number of measurements.

9.16. Printout / approval mode

- PRINTOUT/ APPROVAL KEY (manual control)
 - Never – inactive printout.
 - First stable – the first stable measurement is recorded.
 - Every stable – all stable measurements are accepted.
 - Every – printout of all measurements (stable and unstable), in verified balances only stable results (as in the <Every stable> setting).
- AUTOMATIC MODE
 - Never – inactive printout.
 - First stable – the first stable measurement is recorded after being put on the weighing pan, another stable measurement will be recorded only after removing the load from the weighing pan, when the readout value ‘drops’ below the threshold value and another load is placed on the weighing pan.
 - Last stable – the last stable measurement that occurred before the load was removed is recorded. It is recorded after removing the load from the weighing pan and after the readout value ‘drops’ below the threshold value.
 - With interval – if you select this option, you activate operation of the automatic printout and record of balance readout in the WEIGHING base cyclically with a specific interval. The interval can be set in [min] in the <INTERVAL> parameter. The range of intervals is from 1 s to 9h 59min 59 sec.

NOTE: Every result (stable and unstable when the balance is non-verified, and only stable when the balance is verified) is printed out and remembered.

The automatic operation with the interval starts upon enabling the option. The first stable result that is higher than the THRESHOLD value is printed out and remembered in the first place. Further measurements are printed out with a frequency of the INTERVAL. To end the automatic operation with the interval, disable the option.

- **THRESHOLD:**
the mass value for automatic printout is set in grams.
- **INTERVAL**
the frequency of recording the value for automatic operation with interval

– **Statistics**

It contains settings for statistical calculations during operation.









Available options:



- Global: statistical calculation are performed for all subsequent measurements, irrespective of the product you select
- Product: statistical calculations are performed for particular products

9.17. Printouts

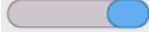

The <Printouts> menu consists of three setting units. The first unit is standard printouts: <Header printout template>, <Weighing record/label printout template>, <Footer/C-label printout>. The second unit is non-standard printouts: <Printout/label base>, and the third unit refers to parameters that allow setting the printing quantities: header, weighing record and footer after a single click of the printout call key.

← Printouts

 Comparison report printout template	 Header printout template
 Weighing / label printout template	 Footer / C label printout template
 Header copy count 1	 Label / printout copy count 1
 C label / footer copy count 1	 Printout / label database

Standard printout comprise 3 sections featuring numerous variables. Set  for each variable that is to be enabled on the printout, set  for each variable that is to be excluded from the printout.

To quickly change the settings press buttons located in the top right-hand corner.



	Press to deselect all marked variables.
	Press to select all marked variables.
	Press to restore default variables.



Procedure:

1. Press the field with the name of the template that is to be edited (Header – Weighing record – Footer) and select variables that are to be printed out.
2. **If you have selected the non-standard printout, it must be created.**

<u>HEADER PRINTOUT TEMPLATE</u>	<u>WEIGHING RECORD/LABEL PRINTOUT TEMPLATE</u>	<u>FOOTER/C-LABEL PRINTOUT TEMPLATE</u>
<ul style="list-style-type: none"> – Non-standard printout – Dashes – Working mode – Date – Time – Balance type – Balance ID – Operator – First and last name – Levelling – Client – Warehouse – Product – Packaging – Universal variable 1...5 – Empty line – GLP report – Non-standard printout 	<ul style="list-style-type: none"> – Non-standard printout – N (measurement number) – Date – Time – Levelling – Client – Warehouse – Product – Packaging – Series number – Batch number – Universal variable 1...5 – Net – Tare – Gross – Current result – Additional unit – Mass – MN-Method – Reference tare – Minimum sample – Minimum sample status – Mass value for titrator – ID – Non-standard printout 	<ul style="list-style-type: none"> – Non-standard printout – Working mode – Date – Time – Balance type – Balance ID – Operator – First and last name – Levelling – Client – Warehouse – Product – Packaging – Universal variable 1...5 – Dashes – Empty line – GLP report – Signature – Non-standard printout

BASIC PRINCIPLES OF USING PRINTOUTS

1. In order to print variables of the GLP PRINTOUT section, press  button on the operation panel; only variables with  attribute can be printed (see the above list).
2. Variables with  attribute, present in the HEADER and FOOTER, are printed **ONLY** upon pressing **PRINT HEADER** and **PRINT FOOTER** pictograms. The pictograms have to be added to the bottom bar of the display as quick access buttons.
(For detailed instruction on how to add quick access buttons to the bottom bar of the display, go to section 12.3)

	
Printout of information in the header	Printout of information in the footer

Note:

Units for mass printout:

- Net – main unit (adjustment)
- Tare – main unit (adjustment)
- Gross – main unit (adjustment)
- Current result – currently displayed unit
- Additional unit– extra unit
- Mass – main unit (adjustment)

Non-standard printout

The printout can contain: TEXTS and VARIABLES (that are collected from the program upon printout). Every printout is a separate template, has its unique name for identification purposes, and is recorded in the database.

Procedure:

1. Press <Non-standard printout> field.
2. Press <Add>  key to open another window with the following data:
Name/Code/Template.
3. Enter the name and code for the printout.
4. Press <Template> key.
5. The screen will show the field with keyboard for edition of the printout.
6. Using the keyboard, you can design the printout; the printout can include texts and variables.

Note:

- The operator can add printouts from the external memory by importing already configured texts with the use of a USB port.
- The name of the printout is ONLY NAME and does not represent its content.
- The method of designing a non-standard printout has been described in the point 13.10 <Printouts>.

9.18. Report on previous comparison processes

Completion of every comparison results in generation of a report. The report is recorded in <Comparison reports> database. The name of the report file takes a form of a date and time of the density determination.

The example of the report:



<i>Report no.</i>	<i>C/31/10/11/11/43</i>			
<i>End date</i>	<i>2017.05.28 11:44:46</i>			
<i>n</i>	<i> A</i>	<i> B</i>	<i> A</i>	<i> D</i>
<i>1</i>	<i> 0.000</i>	<i> 0.131</i>	<i> 0.001</i>	<i> 0.1305</i>
<i>2</i>	<i> 0.002</i>	<i> 0.130</i>	<i> 0.003</i>	<i> 0.1275</i>
<i>3</i>	<i> 0.004</i>	<i> 0.131</i>	<i> 0.004</i>	<i> 0.127</i>
<i>Average difference</i>		<i>0.12833 g</i>		
<i>Standard deviation</i>		<i>0.00189 g</i>		
<i>Method</i>		<i>ABA</i>		

<i>Signature</i>				
.....				

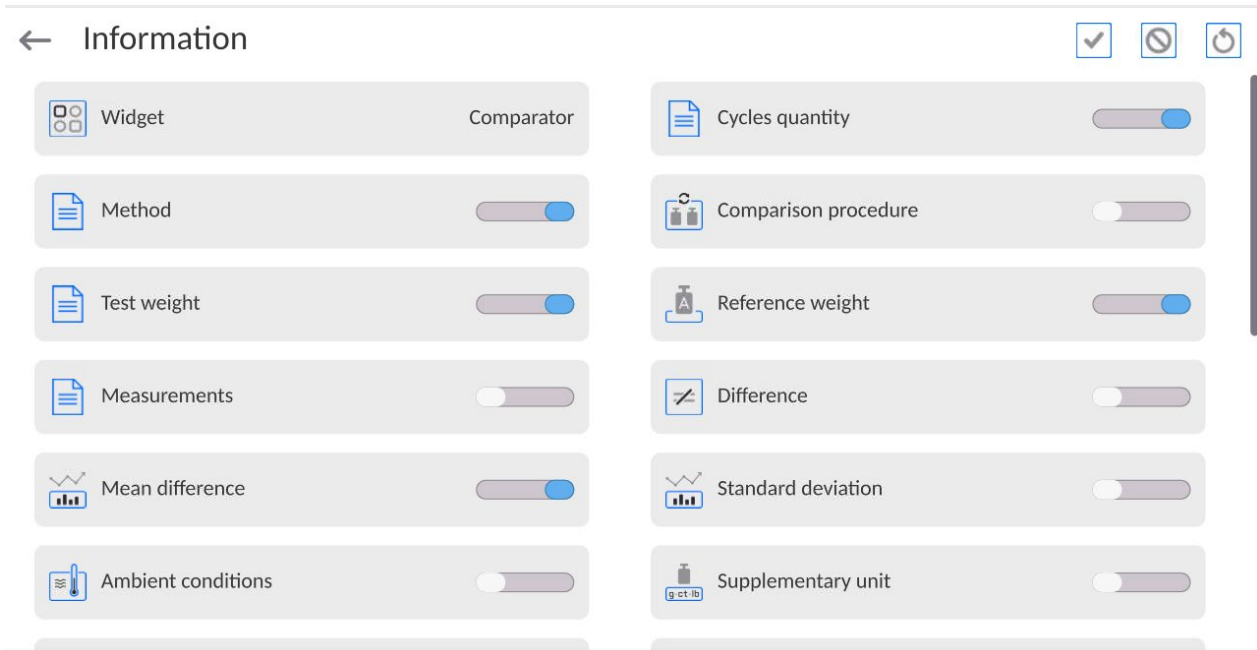
9.19. Management of information in the screen



The operator can quickly change selection of information to be displayed, using keys in the top right corner of the screen.

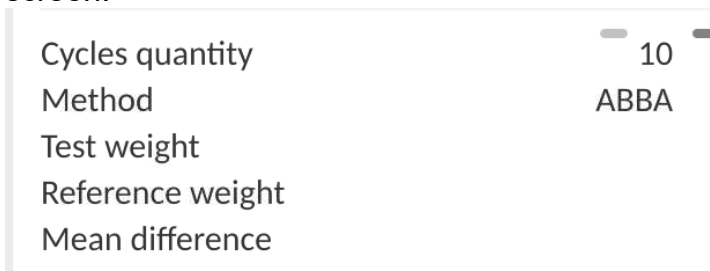

	Unselect all selected information.
	Select all information.
	Restore default selection of information.

The information related to weighing is showed on the left side of the central part of the screen.



You can put 6 pieces of information at the most there. If you have chosen more than 6, the first 6 will be displayed.

For each piece of information, there are two options available:





-  – visible information
-  – invisible information.

9.20. Comparison – basic procedure





1. When you are in the home screen, press  key in the bottom left corner of the screen.
2. Select databases.

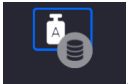

3. Enter Wzorce odniesienia reference weights and define reference weights

4. Return to the database, go to  test weights and define test weights.
5. Return to the database, define  comparison plans.
6. Return to the home screen, and press  comparison plans in the functional key bar, and then select the comparison plan.
7. Place reference and test weights on the loading pan.
8. To start comparison while being in the home screen, press  - the procedure will be initiated instantly as per the previously assigned parameters.

In the comparator, you can calibrate various weight values during one comparison plan. To do so:

1. Define  reference weights and  test weights, and enter the mass of weights to make the comparator adjust internal ballasts automatically.
2. Define  comparison plan.
3. Return to the home screen and press  comparison plans in the functional key bar, and select the comparison plan.
4. Position reference and test weights on the loading pan.
5. To initiate comparison while being in the home screen, press  - the procedure will be initiated automatically as per previously assigned parameters.

10. CALIBRATION

Mass comparators are equipped with an automatic calibration (adjustment) system so that suitable measuring accuracy is guaranteed. The access to calibration control functions is given in <CALIBRATION> menu.

10.1. Internal calibration

The internal calibration utilises the mass inside the mass comparator. The <Internal calibration> key causes the calibration procedure to start instantly. When it is over, the mass comparator displays a message on the end of the process and its status.

Note:

The mass comparator calibration requires stable conditions (no air blows, no floor vibrations), and the calibration procedure must be performed when the weighing pan is empty.



10.2. External calibration

The external calibration is performed with the use of an external standard of a suitable precision and mass, dependent upon the type and loading capacity of the mass comparator. The procedure is semi-automatic while further stages signalled with messages in the screen.

Note:

The external calibration is possible only with regard to mass comparators that are not subject to compliance (verification) assessment.

Procedure:

- Enter <Adjustment> submenu, next select <External adjustment> option.
- Message to remove weight is displayed. Unload the weighing pan and press  button. The balance determines start mass, message: **Start mass determination** is displayed.
- Upon completed start mass determination, message ordering you to load the weighing pan is displayed. Load the weighing pan with weight of respective mass value, and press  button.
- For some balance types, the next message is displayed. Load the weighing pan with weight of subsequent mass value, and press  button.

Upon completed procedure, unload the weighing pan and press  button to confirm. Balance returns to the weighing process.

10.3. Operator's calibration

The operator's calibration can be performed on the basis of any standard whose mass exceeds 0.15 of the maximum loading capacity to the size of the maximum loading capacity of the mass comparator. The calibration procedure is similar to the external equivalent, yet here comes a window for declaration of the standard mass value before the procedure starts.

Note:

The operator's calibration is possible only with regard to mass comparators that are not subject to compliance (verification) assessment.

To initiate the procedure, enter <Calibration> submenu and press: <Operator's calibration> key, and then follow the instructions showed in the mass comparator screen.

10.4. Calibration test

The <Calibration test> function allows comparing external calibration results with the value entered in the factory parameters. Such a comparison allows specifying mass comparator sensitivity drifts in time.

10.5. Automatic calibration

In this menu, declare the factor that determines the time of initiation of the automatic calibration. The following options are available:

- None – automatic calibration is inactive.
- Time – calibration is performed at intervals declared in <Automatic calibration time> menu.
- Temperature – calibration is performed only when the temperature changes.
- Both – temperature change and time determine when the automatic calibration is to begin.

10.6. Automatic calibration time

The <Automatic calibration time> parameter specifies time intervals for the automatic internal calibration of the mass comparator. The period of time is defined in hours, from 1 to 12 hours.

To set the automatic calibration time, please do as follows:

- Press <Automatic calibration time> key.
- Based on the menu, select the period of time (given in hours) that is to pass from the last calibration to perform another internal calibration.

10.7. Report printout

The <Report printout> parameter specifies if the calibration report is to be printed out automatically after the calibration is finished.

To print the report out automatically, set the active printout function of the parameter.

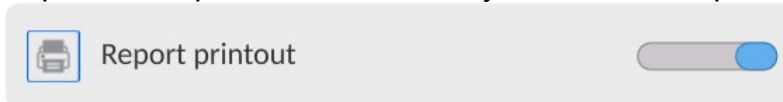

10.8. GLP template

GLP is one of the ways of documenting work in accordance with the quality system in place. The information selected for printout will be printed out together with every mass comparator calibration report. The operator can use the following information and marks:

- Calibration
- Working mode
- Date
- Time
- Balance type
- Balance ID
- Operator
- First and last name
- Levelling
- Nominal mass
- Current mass
- Difference
- Temperature

- Dashes
- Empty line
- Signature
- Non-standard printout

10.9. Calibration history

It contains all mass comparator calibrations. The record is automatic. Every recorded calibration contains basic data on the process. From this menu, you can display a list of calibrations recorded. Every report can be printed out.

To print the calibration report out, enter <Calibration> submenu and then <Calibration history>.



Select the calibration you wish to print out and press <> printer icon in the upper bar.

Note:

If the mass comparator memory is full, the oldest record in the list will be deleted automatically.

If internal procedures require complete documentation for all calibrations, the list with records must be periodically printed out and archived.

Searching for the completed calibration



It is possible to search for information on the completed calibration: press  key and enter the completion date.

Exporting information on completed calibrations

To export information on completed calibrations, insert a USB mass memory into the mass comparator port. Next press <Export data> key located in the top right corner of the screen. The procedure is automatic. Once it has ended, a file with **.tdb** extension is saved and you can edit it, for example in the Excel program or text editor.

11. ADMINISTRATOR PANEL

This menu group specifies a range of actions that may be taken by the operator with specific permission level, password protection level and permission for unlogged operator.

NOTE: Only the operator with <Administrator> permission level is authorised to modify this menu.

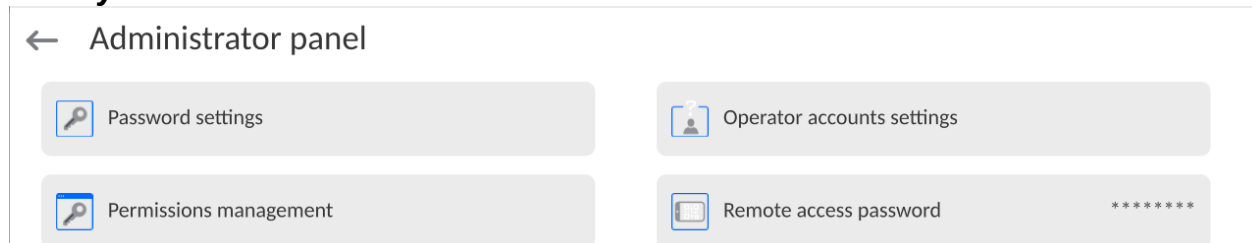

11.1. Password settings

The menu group allowing you to specify the password complexity for balance operators.

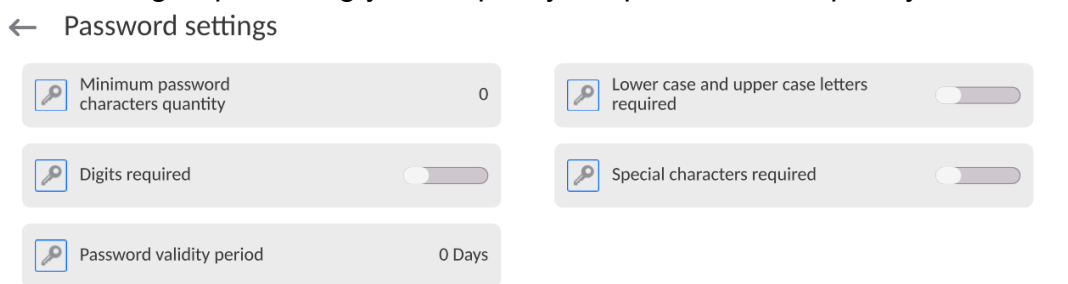

Minimum password length	Specification of the minimum number of characters in the operator's password. For '0' value, you can set any number of characters.
Require lower-case and upper-case letters	Specification of requirements concerning characters in operators' passwords.
Require digits	
Require special characters	
Password validity period	Specification of a period of time, in days, which when expired requires you to change the password. For '0' value, the change of password is not required by the balance program.

11.2. Operator's accounts setting

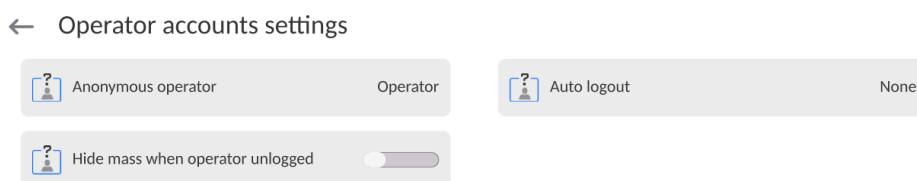

Unlogged operator's permission

The administrator can assign permission levels to the balance operator who has not logged in (the so-called anonymous user).

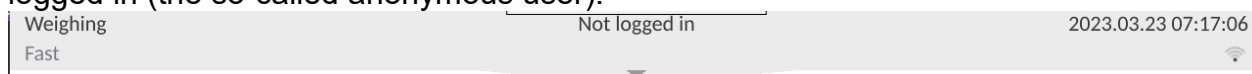

Procedure:

Enter <Operator account settings> parameters group, choose <Unlogged operator permission> variant, and then select of the following: Guest, Operator, Advanced Operator, Administrator.

Note: If <Guest> is chosen, the unlogged operator will not be entitled to change settings of the program.

Automatic logout

The option allowing you to activate the automatic logout upon expiration of the specific period of time, given in minutes, if the balance is not used. By default this option is inactive in the balance (setting: <None>).

Procedure:

Enter <Operator accounts settings> parameters group, select <Automatic logout> option and then select any of the following: none/3/5/15/30/60. Time is given in [min].

Hide mass when the operator is not logged in

The option allowing you to deactivate the mass display if the operator is not logged in. By default this option is inactive in the balance.

Procedure:

Enter <Hide mass when operator is not logged in> option and then turn the value into active.

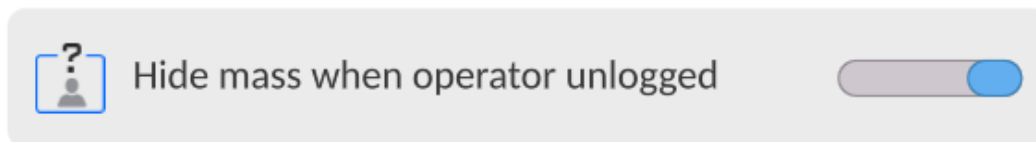

11.3. Permission management

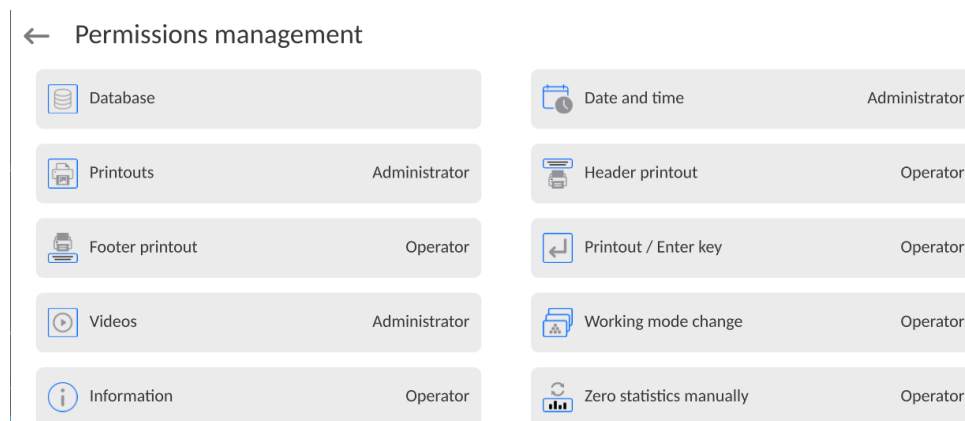





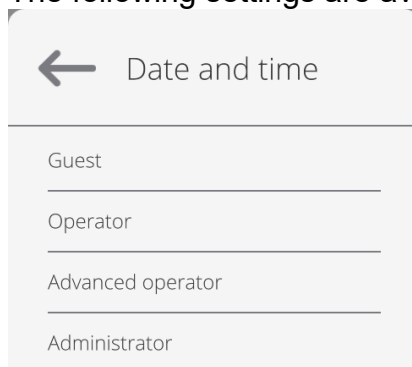







Note: If you set the permission level as <Guest> for particular parameters, the access to settings will be open (no need to log in).

For each option, you can assign the permission level for edition purposes. The following settings are available:



Databases

← Database

 Databases preview Operator	 Products Administrator
 Customers Administrator	 Packaging Administrator
 Warehouses Administrator	 Reference weights Administrator
 Test weights Administrator	 Comparisons procedures Administrator
 Adjustment weights Administrator	 Printouts / Labels Administrator
 Universal variables Operator	 Delete weighing records and reports Advanced operator

Default balance settings allow the operator logged as an **Administrator** to make changes to settings of particular databases. Depending on requirements, these permission levels can be changed.

Similarly, you can change permission for edition of other options available in this menu.

11.4. Remote access password

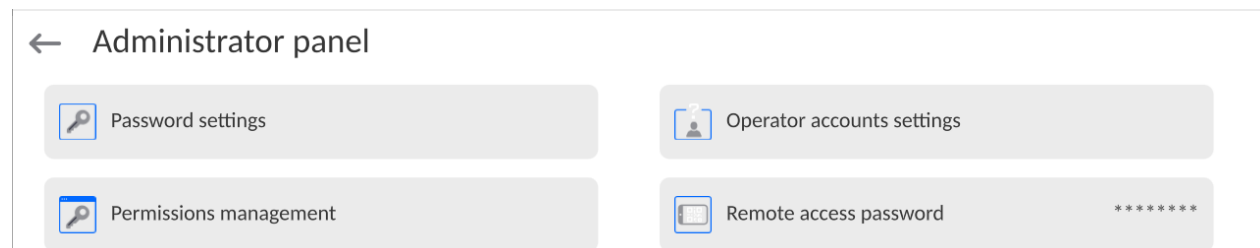

The balance allows you to gain a remote access through a connection of the balance to the local Internet network which a PC is connected to. The **VNC Viewer** application is dedicated in this respect.

The default access password set in the program is a sequence of characters: **radwag1234**. If the operator does not intend to use the default password, he needs to set a unique access password in the aforesaid parameter.

Note: please remember a new password in order not to lose a remote access to the balance.

12. PROFILES

The profile is a set of information describing:

- how a function is to work; e.g. counting details, deviations %, etc.,
- what information will be displayed during operation,
- what keys will be active,
- which units will be available,
- what criteria apply to balance speed and result stabilisation.

The balance program allows you to create numerous profiles, which in reality means that:

- every operator can create its own working environment,
- it is possible to design the mode of balance operation through keys and information that are required (work ergonomics).

To make the work with the balance easier, there are four default profiles in the program. The settings have been selected and saved for these profiles to make sure the weighing is optimal for specific expectations and conditions.

The following profiles are available:

- **Fast** – the profile that allows you to quickly weigh any masses, regardless of the working mode. Upon the first activation, the balance launches this profile automatically. For this profile, parameters have been selected to make sure the final result of the measurement is achieved as quickly as possible,
- **Fast dosing** – the profile dedicated to dosing and allowing quick mass dosage. The selection of this profile leads to automatic activation of the DOSING mode,
- **Precision** – the profile dedicated to precise weighing of any masses, regardless of the working mode. For this profile, the weighing procedure is the longest but the final result is the most precise and accurate,
- **User** – the basic profile whose filter settings have been selected to make sure weighing is relatively fast and precise. Selection of this profile leads to automatic activation of the WEIGHING mode.

***Note:** the operator can modify profile settings comprehensively, only in User profile. With regard to other default profiles (Fast, Fast dosing and Precision), modifications are limited. Every additional profile created by the operator can be modified thoroughly.*



12.1. Profile creation

The balance administrator can create new profiles by:

- copying an already existing profile and modifying it,
- creating a new profile.

Copying the existing profile



Procedure:

- Enter the main menu. To do so, press .
- Next enter  < > submenu.
- Press and hold the key with the profile name that is to be copied.
- A menu will be displayed. Select <Copy> item.

- A profile called <Copy name> will be created. All settings will be identical to the settings of the basic profile.
- After copying, change data that must be modified: (name, etc.).

Adding a new profile



Procedure:

- Enter the main menu. Do to do, press  key.
- Next enter < > submenu.
- Press  key.
- The program will add a new profile and enter the edition box automatically.



Deleting the profile

Procedure:

- Enter the main menu. Do to so, press .
- Next enter < > submenu.
- Press and hold the key with the profile name that is to be deleted.
- The menu will be displayed. Select <Delete> item from the list.
- Next the following message will be displayed: <Are you sure you want to delete?>.
- Press  key to confirm the message. The profile will be deleted.

Note: Profile operations are possible after you have logged in as Administrator.

12.2. Profile structure

The following items are available in each profile:

Settings The menu allowing you to assign a unique profile name (a sequence of alphanumerical characters) and declare which mode is to be a default mode (the selected mode will always be loaded as a default mode after selecting the profile).

Working modes The option allowing you to set options specific for particular working modes. There are such submenus as:

- Additional settings related to the mode
- Keys
- Information
- Printouts

Readout It contains such submenus as:

- Filter
- Result approval

- Autozero
- Autozero: Dosing
- Last digit
- Number of last digits
- Environment

Units

The menu allowing you to declare the start unit, additional unit, 2 defined units, and to introduce the gravitational acceleration value in the place of using balance as well as declaring availability of particular units.

12.2.1. Settings

Name

After entering this option, the screen will show a window with a keyboard. Enter the profile name and press  key to confirm. The new name will apply to the profile.

Default working mode

Enter this option and select a specific working mode as a starting mode for the profile. In case of <None> option, select the profile and the balance will keep a recently used mode.

12.2.2. Working modes

After entering this option, a window will be displayed with all available working modes. The operator can introduce his own settings for each mode. They will be called after selecting a specific mode.

The following parameters are available for each of the working modes:

- Settings:
they contain specific settings related to the working mode and universal settings, such as result control, tare mode, automatic footer printout, printout mode, printout.
- Quick-access key functions:
declaration of keys that will be visible in the lower part of the screen.
- Information:
selection of information to be displayed in the grey information field.
- Printouts:
selection of a type of printout or defining of the non-standard printout.

12.2.3. Readout

The operator can adapt the balance to external environmental conditions (filters degree) or own needs. The <Readout> menu consists of the following items:

FILTER (unavailable to the following profiles: Fast, Fast dosing, Precision)

Before it is displayed, every measuring signal is electronically processed in order to achieve correct parameters, typical of the stable signal, that is ready for readout.

To a certain extent the operator can influence processing by selecting a suitable FILTER.

Scope of selection:

- very fast, fast, medium, slow, very slow.

Choosing the filtering level, you need to consider real working conditions of the balance. For very good conditions, you can set the medium or fast filter, and for unfavourable: slow or very slow filter.

Note:

- *for precise balances, it is advisable to choose fast ÷ medium filters,*
- *for analytical balances and microscales, it is advisable to choose medium ÷ very slow filters.*

Result approval (option unavailable to profiles: Fast, Fast dosing, Precision)



It determines the time of displaying the stability mark for a measurement result.

You can set one of three result approval options:

- fast, fast + precise, precise.

Note: *How quickly the stable result is achieved depends on the type of filter used and specific result approval.*

Autozero function

The task of this function is automatic control and correction of the zero readout. When the function is active, subsequent results are compared in fixed time intervals. If these results differ by the value smaller than the declared scope of AUTOZERO, e.g. 1 unit, the balance will automatically reset itself and stable result marker -  and zero marker  will be displayed. When the AUTOZERO function is active, every measurement always starts from zero. There are special cases in which this function is an obstacle to measuring. The example can be a very slow placement of the load on the weighing pan (e.g. pouring the load in); this being the case, zero indication correction unit can also correct real mass of the load.

Available values: **NO** - autozero function inactive.
 YES - autozero function active.

Autozero function: Dosing (option unavailable to the following profiles: Fast, Fast dosing, Precision)

The task of this function is default setting of the autozero in the dosing function.

Available values:

NO - autozero becomes inactive automatically after entering the Dosing mode.
YES - autozero becomes active automatically after entering the Dosing mode.

Last digit

Using this function, you can disable visibility of the last decimal place in the exposed weighing result. The function offers three settings:

- **Always:** all digits are visible.
- **Never:** last digit of the result is disabled and is not displayed.
- **When stable:** last digit is display only when the result is stable.

Number of last digits

Using this function, you can declare the number of hidden last result digits. The function offers three settings and works in connection with <Last digit> option:

- **1:** last digit of the result.
- **2:** last two digits of the result.
- **3:** last three digits of the result.

Environment

This parameter refers to the environment and conditions which the balance is working in. If environmental conditions are unstable, it is advisable to change the parameter into Unstable. By default this parameter is set as Stable.







The Stable setting causes the balance to work much faster. In effect the weighing time is a way shorter when compared to the Unstable parameter.

– **Unstable; Stable.**

12.2.4. Units

The operator can declare a start unit and additional unit as well as two defined units for the specific profile.

← Units



 Available units	 Start unit
 Supplementary unit None	 Custom unit 1
 Custom unit 2	 G-core value

Here, it is also possible to enter the gravitational acceleration value in the place of using the balance. It is required for using the mass value in [N].

The defined unit has the following:

- Pattern (*defined unit calculation pattern*): Coefficient * Mass or Coefficient / Mass.
- Coefficient (*declaration of the defined unit calculation coefficient as per the specific pattern*)
- Name (unique unit name displayed by the result
- *max. 3 characters*)

← Custom unit 1

 Formula Factor * Mass	 Coefficient
 Name	

In case such a unit is designed, its name will be visible in the list of available units; this option is only available to non-verified balances.

13. DATABASES

The balance software offers the following databases:

← Database



Operators



Products



Customers



Reference weights



Test weights



Comparisons
procedures



Packaging



Warehouses



Printouts / Labels



Universal variables



Manage the
database

13.1. Operations in databases

The operations in databases are only available to the authorised operator.

To edit Bases, follow the steps below:

- Press and hold the icon field applicable to the specific base.
- The relevant menu will be showed in the screen.
- Select one of the available options (available options depend on the type of base you choose).

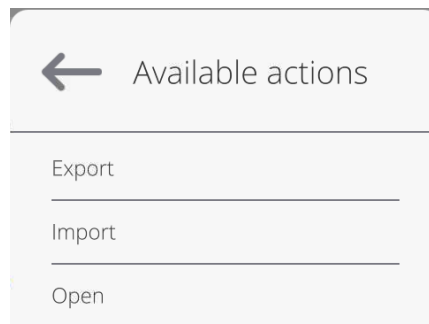

Selection of options:

- **EXPORT** – the option allowing you to export data saved in the database to the pendrive external memory. Before you select the option, connect the memory to any USB port. If the program can detect the memory, it will initiate the copying procedure automatically. Once the copying procedure has been completed, you will see the window with the <Ended> message and name of the file which the data from the base have been saved on. Now you need to approve it.
- **IMPORT** – the option allowing you to import data from the pendrive external memory. Before you select the option, connect the memory to any USB port. If the program can detect memory, a window with saved files will be displayed. Specify the file with data to be imported. Selection of the file initiates the copying procedure automatically. Once the copying procedure has been completed, you will see the window with <Ended> message. Now you need to approve it.
- **OPEN** – the option allowing you to enter the specific database (similar when you single click the field of the base).

After entering the base you have selected, the following operations are possible (depending on the type of base):

1. Adding items to database.
2. Searching for an item in the base by name.
3. Searching for an item in the base by code.
4. Searching for an item in the database by date.
5. Exporting data from the base to USB mass memory.
6. Printing information on record in the database.

The above-stated actions are initiated through buttons located in the top right corner of the screen. Follow the messages displayed in the screen.

13.2. Operators

The menu contains a list of operators who can use the balance.

For each operator, you can define the following information:

Name	Code
Password	First and last name
Permission levels	Active account
Language	Default profile
Card number	Fingerprint (<i>parameter visible only after connecting the fingerprint scanner</i>)
Face profile	Motif

NOTE: Only the operator logged as Administrator can add new operators or delete operators from the base.

To add a new operator, you need to do as follows:

- In <Operators> menu, press <Add>  key.
- Define fields for a newly created operator.

Note: You can browse through the operators base by code or operator's name.

Logging via a transponder card:

Note: A RFID scanner mounted in the head works at a frequency of 13.56MHz and complies with ISO/IEC 14443 Type A.

Only cards in this standard will be recognised by the scanner.

- Enter the operator's settings

- Select <Card number> option

← Card no.

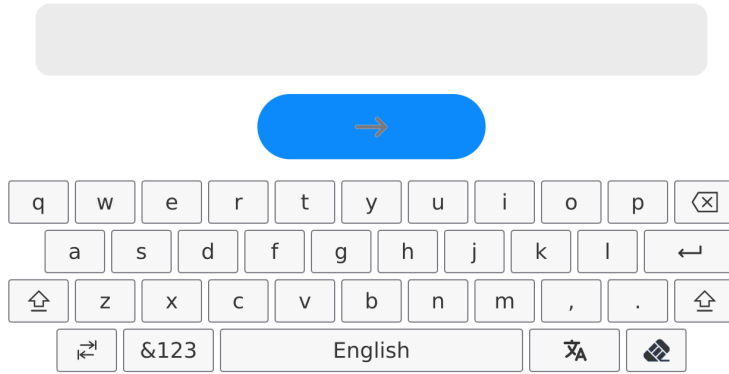

- Put the card against the RFID scanner
- The card number will be automatically entered into the edition field



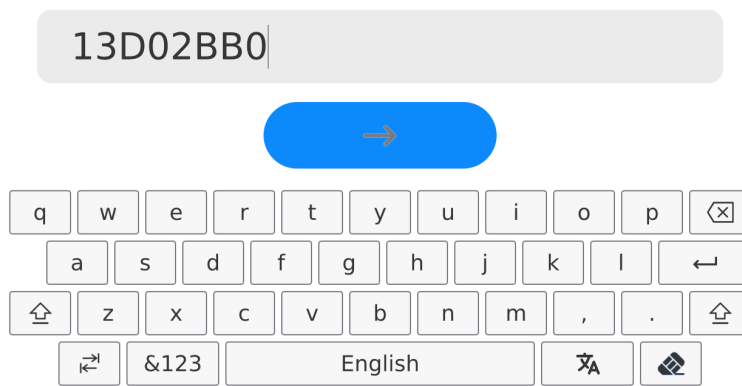







← Card no.



- Press  key and the card number will be added to the operator's settings

← Edit record



 Name	 Code tc
 Password *****	 Name and Surname
 Permissions Operator	 Account active <input checked="" type="checkbox"/>
 Language Use default language	 Default profile None
 Card no. 13D02BB0	 Face profile
 Theme Dark	

- Go to the main menu. From this moment on, you only need to put the card against the RFID scanner to log in.

Logging via fingerprint:

Note: It is only possible to connect the fingerprint scanner listed as a dedicated product for such balances. The list of accessories can be accessed on the RADWAG's website.

- Connect the fingerprint scanner to the USB type-A port and the <Fingerprint> option will become visible in the operator's settings menu

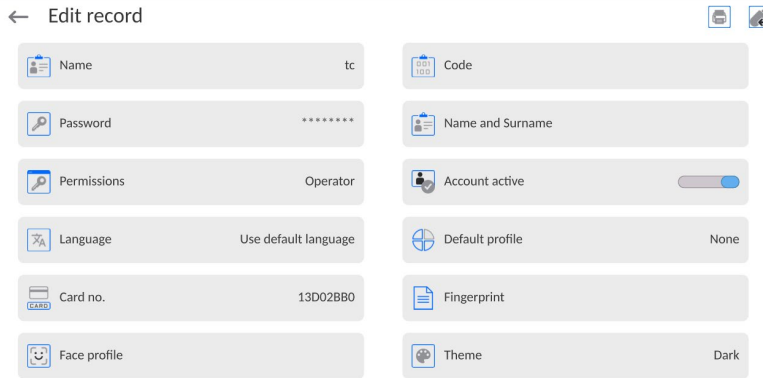

- To add a fingerprint for the operator, enter this option

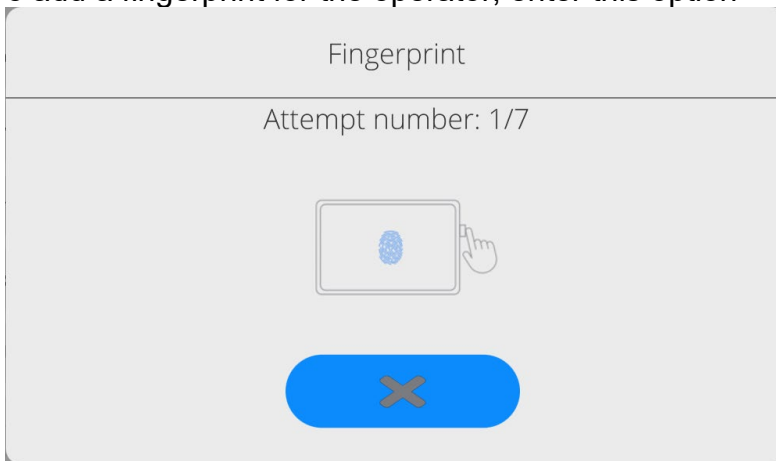

- Scan a fingerprint and repeat the procedure 7 times (as per the message in the box).
- Once the procedure has been successfully completed, a summary box will be displayed.

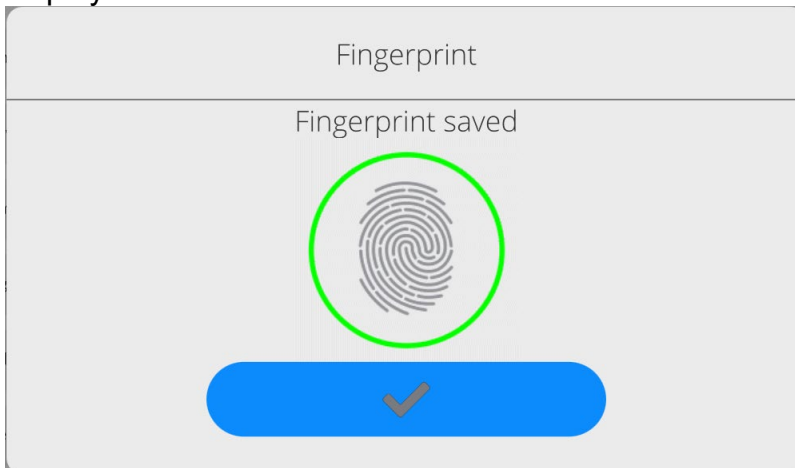

- Now confirm the operator fingerprint assignment procedure by pressing  key.

- From now on, if the fingerprint scanner is connected to the USB port, the operator login window will show an active fingerprint login pictogram.

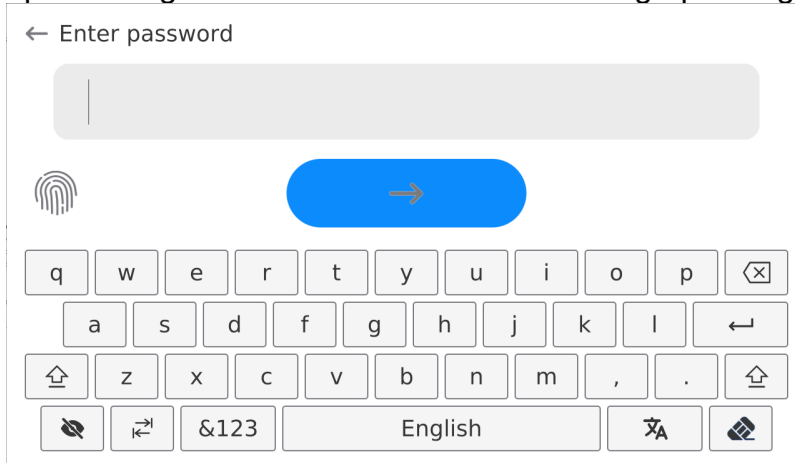

- After putting the finger against the scanner and confirming the match between the fingerprint and pattern, the pictogram will turn green for a while and the operator will be automatically logged in. The program will show the home screen, and the name of the operator will be visible in the upper bar.
- If the scanned fingerprint does not comply with the pattern, the pictogram will turn red for a while and the operator will not be logged in. A login box will remain visible.

Login via face profile:

- To add a face profile to the operator, enter this option

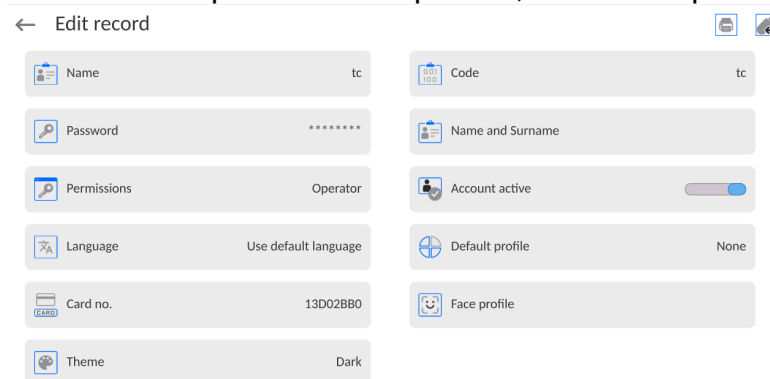

- After activating the option, you will see a message and the face profile will be read. Therefore you need to position yourself in front of the camera properly

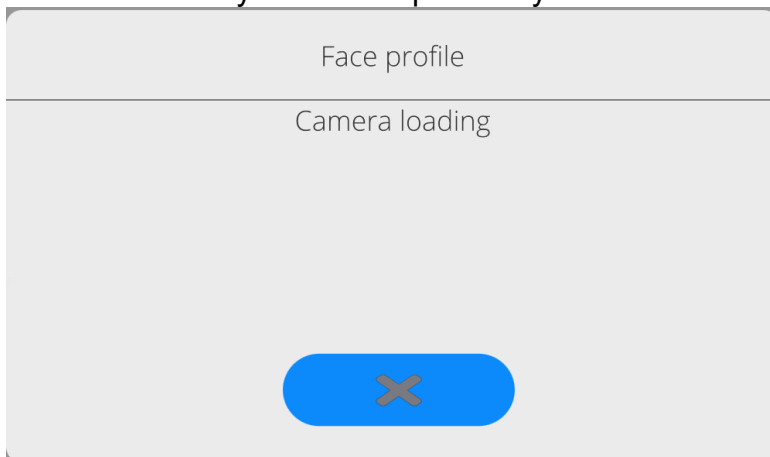

- so that the program can save your profile in the memory.

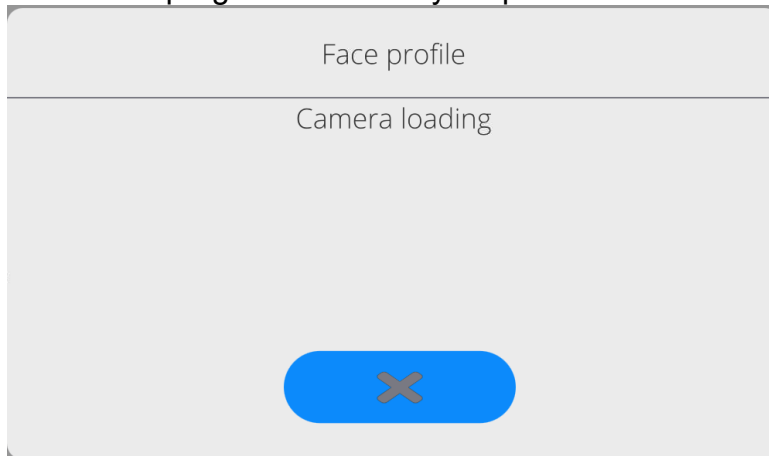

- After saving the profile, the message together with the camera photo will be displayed.

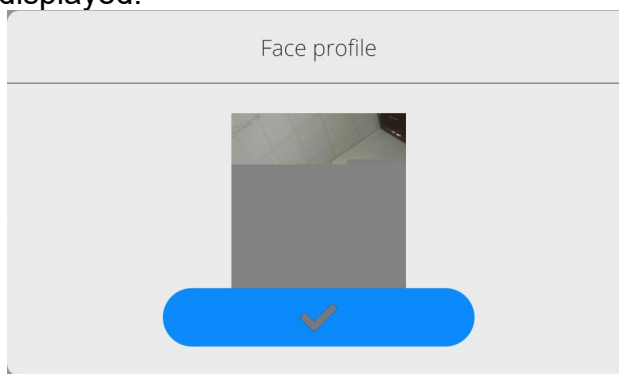

- Close the window by pressing  key.
- In the operator's settings box, the description of the option will turn into <Delete face profile>, which means that the profile has been saved in the balance memory.

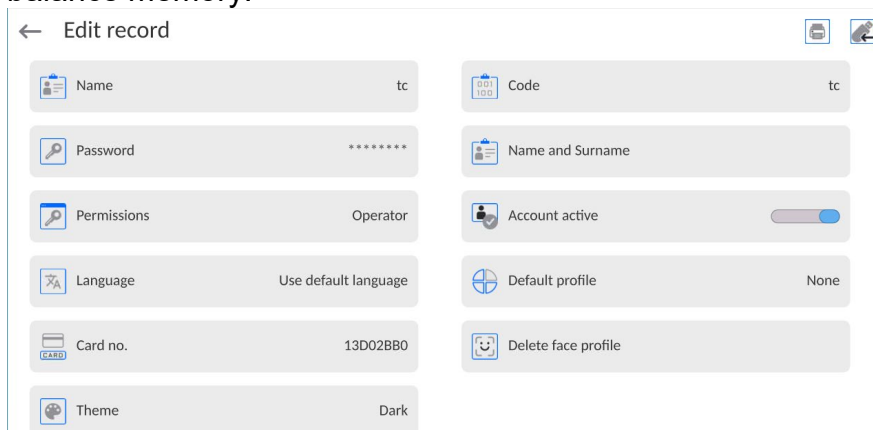

- From now on, if the operator assigned a face profile tries to log in, the program will automatically scan the profile after entering the login box, which

will be signalled by the pictogram on the left side of the window.

← Enter password

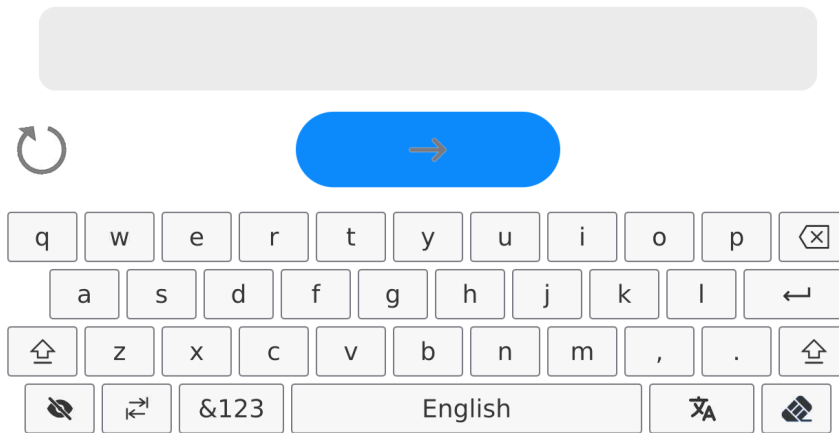

- The program automatically reads the photo of the operator's face profile and loads the photo. Then the camera is turned on (it is heralded by the LED light glowing next to the camera) and the saved photo is compared with the one read by the camera. If these images match, the home screen of the program will be displayed and the name of the logged operator will be visible in the upper bar of the screen.

Edition of information related to the operator:

- Press the field with the operator's name.
- The screen will show properties related to the operator.
- Select and modify required data.

To delete the operator, do as follows:

- Press and hold the operator's name.
- The screen will show the relevant menu.
- Select <Delete> item and confirm your choice.

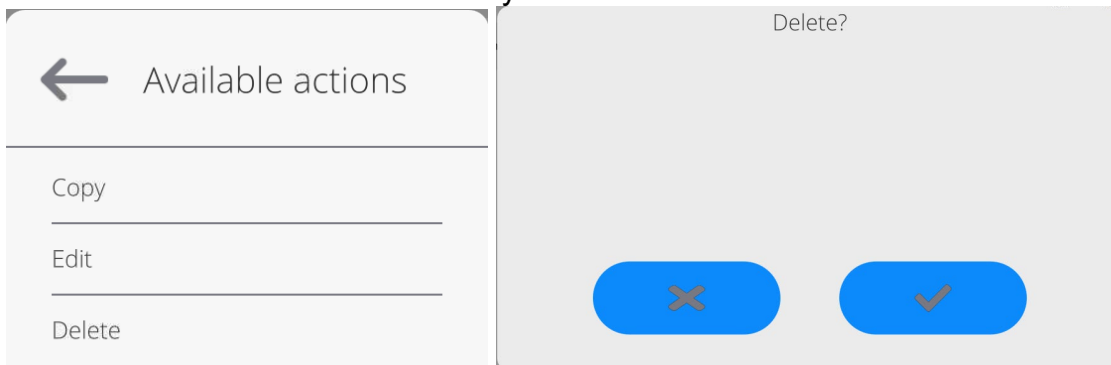

13.3. Products

The product base contains names of all elements that can be weighed, counted, controlled.

Procedure:

- Enter <Database> submenu and press <Products> item.
- Press <Add> key if you wish to add a new product.
- If the product already exists, press the field with product name.

The list of information defined for the product:

1. Name [product name]
2. Description [product description]
3. Code [product code]

4. EAN code	[product EAN code]
5. Mass	[nominal/unit mass of the product]
6. Min	[minimum mass during product weighing in sections result control – LO. Error value <T1-> for <Mass control> mode, defined in percent of the nominal mass]
7. Max	[maximum mass for product weighing in sections result control – HI. Error value <T1+> for <Mass control> mode, defined in percent of the nominal mass]
8. Tolerance	[% value in relation to the mass (5), shows the field in which the measurement is considered as correct]
9. Tare	[value of the product tare, set automatically for selection of the product from the base]
10. Price	[product unit price]
11. Density	[product density used for compensation of air displacement as a sample density] - [g/cm ³]
12. Validity days number	[number of days of validity]
13. Date	[fixed product date]
14. VAT	[VAT tax related to the product]
15. Ingredients	[edition box for names of ingredients which the product is made of, e.g. when it is a mixture or additional description concerning properties or application]
16. Printout	[printout template assigned to the product]

Note: Please remember to make sure the products are assigned to relevant functions. The values will be automatically adapted to the function used by the operator to enter the database.

13.4. Customers

The Customers database contains names of Recipients which weighing is performed for.

Procedure:

- Enter <Databases> submenu and press <Customers> item.
- Press <Add> key.
- If the Customer field already exists, press the field with a relevant name.

The list of information defined for customers:

1. Customer name
2. Customer code [internal identification code of the customer]
3. NIP [taxpayer's ID]
4. Address
5. Postal code
6. City/town
7. Discount
8. Printout [type of printout, label related to the customer]

13.5. Reference weights

The Reference weight base contains a list of reference weights used for comparison of weights. The reference weights are used for defining comparison plans.

Procedure:

- Enter <Databases> submenu and press <Reference weights> item.
- Press <Add> key if you want to design a new reference weight.
- If the reference weight already exists, press the field with its name.

Note:

You can use <Search by name>, <Search by code>, <Export data> options.

The list of information defined for reference weights:

1. Name
2. Code
3. Class
4. Factory number
5. Mass
6. Set number

13.6. Test weights

The test weights base contains a list of test weights used for comparison of weights. Test weights are used for defining comparison plans.

Procedure:

- Enter <Databases> submenu and press <Test weights> field.
- Press <Add> key if you want to design a new test weight.
- If the test weight already exists, press the field with its name.

Note:

You can use <Search by name>, <Search by code>, <Export data> options.

The list of information defined for test weights:

1. Name
2. Code
3. Class
4. Mass
5. Order number
6. Test weight number

13.7. Comparison plans

The comparison plan base contains a list of defined comparison plans. Comparison plans are created to automatically compare weights after prior definition of reference weights and test weights.

Procedure:

- Enter <Databases> submenu and press < Comparison plans> field.
- Press <Add> key if you want to design a new comparison plan.
- If the comparison plan already exists, press the field with its name.

Note:

You can use <Search by name>, <Search by code>, <Export data> options.

The list of information defined for comparison plans:

1. Name
2. Code
3. Comparison plan template (always YES if it is to be remembered)
4. Start delay
5. Start time
6. Clear start time
7. Comparisons

After entering information from points 1-6, enter the Comparison field, add a new comparison, and then assign relevant features to it:

1. Reference weight
2. Test weight

3. Number of cycles
4. Method
5. Number of test runs
6. Number of repetitions

Next you can analogically assign another comparison to the same comparison plan. The number of comparisons in one comparison plan depends on the number of test weights and reference weights handled by the comparator.

13.8. Packaging

This is a list of packaging to which you need to assign a name, code and mass value. During weighing, after selecting a name, a tare value will be automatically called. The screen will show the value with a minus sign.

Procedure:

- Enter <Databases> submenu and press <Packaging> field.
- Press <Add> key if you want to add a new packaging.
- If the packaging already exists, press the field with its name, enter information related to the packaging.

Note:

You can also search by name or code.

13.9. Warehouses

Depending on the organisation of work, Warehouses contain a list of places which the sample for weighing has been collected from, or places which the sample has been delivered to. For each warehouse, please enter the name, code and description. During weight, after selecting the name of the warehouse, it is automatically assigned to the result.

Procedure:

- Enter <Databases> submenu and press <Warehouses> field.
- Press <Add> key if you want to add a new warehouse.
- If the warehouse already exists, press the field with its name and enter identification data.

Note:

You can also search by name or code.

13.10. Printouts

The printout base contains all NON-STANDARD printouts. Each of them has its name, code and the so-called template.

Procedure:

- Enter <Databases> submenu and press <Printouts> field.
- Press <Add> key if you want to add a new printout.
- If the non-standard printout already exists, press the field with its name and enter identification data.

Note: *You can also search by name or code.*

Designing a new printout.

Procedure:

- Enter <Databases> submenu and press <Printouts> field.
- Press <Add> key and create a new printout or edit the existing one.

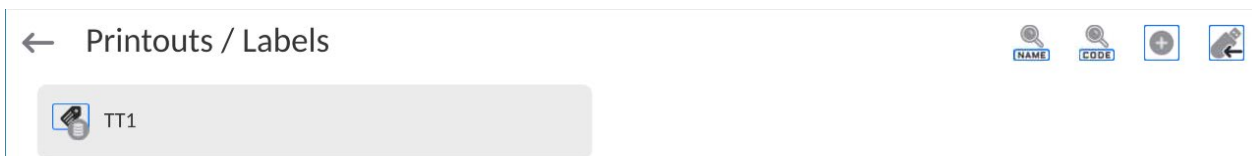

- In <Record edition> field, press <Template> key.
- The screen will show the window for creation of any printout.
- While creating a printout, you can use an external USB keyboard connected to the head, or a touch keypad that offers the same functions as a typical PC keyboard.

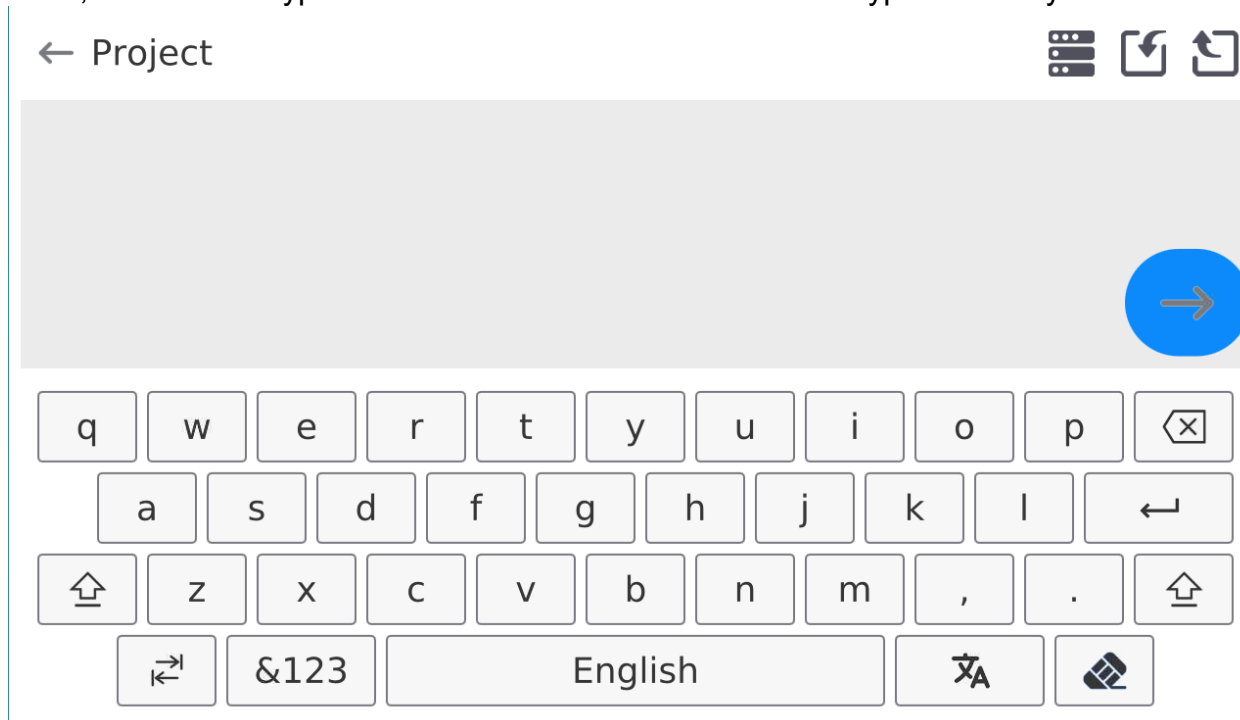

The displayed keypad does not provide some characters and signs, such as colon or diacritical signs typical of a language (menu language is signalled with the 'SPACE' key description). To use such signs in the printout designed, **press and hold** a specific letter on the keyboard for a while. This will cause additional keys with assigned signs to be displayed. You can click them to add a text. After you have entered the sign, disable the signs by pressing the 'X' key.

The example of available characters for Polish keyboard.

Letter on the keyboard	Additional characters	Letter on the keyboard	Additional characters	Letter on the keyboard	Additional characters
„t”	€ ✕ t y	„u”	µ ✕ u i	„a”	~ ✕ a s
„x”	ı ` ✕ x c	„c”	\\ ✕ c v	„v”	[{ ✕ v b
„b”] } ✕ b n i	„”	: < = ✕ , . ↵	„”	; > ✕ . ↵

- Save the printout you have created.

The example of the printout 1 – use of large edition box

← Project

BALANCE NO: {32}
Max=220 g
d={33}

PRODUCT: {50}
DATE: {2}
TIME: {3}

WORKING MODE: {5}

Template

Balance no. 400015
Balance parameters:
Max = 220 g
d= 0.001 g

Product name:
Date: 2011.10.24
Time: 11:48:06

Balance working mode: Weighing

Net mass: 94.147

Measured by: Admin





Template printout

The example of printout 2 – printout from the file

All printout templates can be prepared as external files that can be imported to the balance. Such a file must come with *.txt or *.lb extension and contain all permanent and variable information. The content of such a file can be modified after importing.

Procedure:

- create a *.txt or *.lb file in any editor,
- copy the file to the external USB memory,
- insert the USB memory into the balance port,
- press [4] <  download printout from file> key,
- the balance screen will show the content of USB memory,
- search for the file with printout and press its name,
- the printout will be automatically copied into the edition box.

	<i>The operator can add printouts from the external memory by importing already configured texts with the use of a USB port.</i>
	<i>The printout name does not represent the content of the printout.</i>
	<i>The list of variables intended for printouts can be accessed in the 'ATTACHMENTS 03' manual.</i>
	<i>The example of creating and sending the label template to the balance memory can be found in the 'ATTACHMENTS 03' manual.</i>

13.11. Universal variables

Universal variables are alphanumeric information that can be associated with printouts, product or other comparison-related information. For each variable, you need to enter name, code and value.

Procedure:

- Enter <Databases> submenu and press <Universal variables> field.
- Press <Add> key if you want to add a new variable.
- If the variable already exists, press the field with name and make relevant modifications to fields: code, name, value.

Note:

You can also search by name or code.

13.12. Databases management

The function allowing you to manage data in bases.

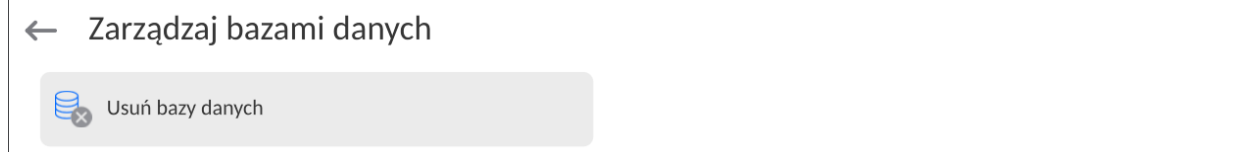

14. REPORTS

The reports menu contains all ultimate bases which measurements and measurement reports are saved in.

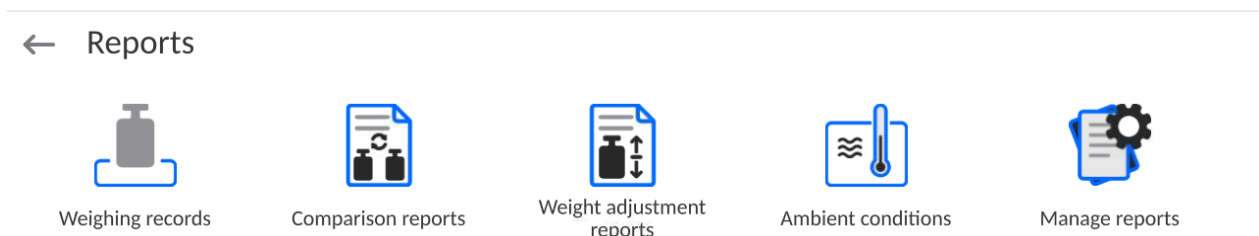

14.1. Operations in databases

Report-based operations are available only to the authorised operator.

To edit Bases, follow the steps below:

- Press and hold the field with base icon.
- A relevant menu will be showed in the screen.
- Select one of the available options (available options depend on the type of the base you have selected).

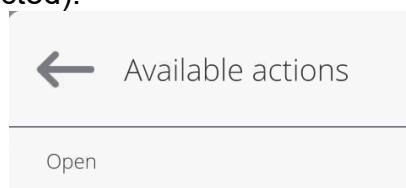

Selection of options:

- OPEN – the option allowing you to enter the specific database (identical to single clicking the base field).

After entering the base, you can perform the following operations (depending on the type of base):

1. Search for the item in the database by name.
2. Search for the item in the database by code.
3. Search for the item in the database by date.
4. Export data from the database to the USB mass memory.
5. Print information on the record in the database.

The above-stated actions can be initiated through keys located in the top right corner of the screen. Follow the messages displayed in the screen.

14.2. Weighing records

Every weighing result sent from the balance to the printer or PC is saved in the weighing base (see: exception point Result control).

The operator can preview data for particular weighing.

Procedure:

- Enter **<Reports>** submenu.
- Enter **<Weighing/Alibii>** submenu and press the desired item.

The list of information in the database for a specific weighing:

1. Weighing date.
2. Weighing result.
3. Tare value.
4. Statement if the measurement was stable.
5. Statement if the air displacement control function was enabled
6. Product name.
7. Operator.
8. Customer, business partner's name.
9. Working mode name.
10. Warehouse, source warehouse name.
11. Packaging, tare name used during product weighing.
12. Result control, information which field the result was in:
MIN – below threshold (possible only when <Result control – NO>),
OK – between thresholds,
MAX – above threshold (possible only when <Result control –NO>).
13. Platform number, field shows platform (balance) number which the weighing was performed on.
14. Levelling shows if the balance level was maintained during measurement.
15. Environmental conditions alerts show if the temperature and humidity were stable during measurements.

14.3. Comparison reports

The comparison reports base contains information on weight comparison procedures. For each report, you can preview, search by date, export and print out.

Procedure:

- Enter <Databases> submenu and press <Comparison reports> field.
- Press the field with its name.

The list of information included in the comparison report:

1. Order number

2. Start date
3. End date
4. Operator
5. Diameter
6. Standard deviation
7. Number of cycles
8. Reference weight
9. Test weight number
10. Task
11. Method

14.4. Weight adjustment reports

The weight adjustment report base contains information on weight adjustment procedures. For each report, you can preview, search by date, export and print out.

Procedure:

- Press <Database> submenu and press <Comparison reports> field.
- Press the field with its name.

The list of information included in the comparison report:

1. Order number
2. Start date
3. End date
4. Operator
5. Diameter
6. Standard deviation
7. Number of cycles
8. Reference weight
9. Test weight number
10. Task
11. Method

14.5. Environmental conditions

It contains information related to the environmental parameters. Depending on the balance configuration, such a list may include temperature, humidity, atmospheric pressure values. When a THB environmental module is connected to the balance, the information on its readouts will be recorded too.

Procedure:

- Enter <Reports> submenu and press <Environmental conditions> field.
- Press the field with a specific report if it is invisible, scroll the list of reports via navigation keys.
- The name of the report consists of the date and time.

Note: *You can also search for the report.*

14.6. Reports management

The function allowing you to manage data in the reports base. The following options are available: Export weighing base to file and Delete weighing records and reports.

← Manage reports

Export weighing records database

Delete weighing records and reports

Global weighing count 13

14.6.1. Export weighing base to file

All completed weighing records are saved in the Weighing database. This information can be exported to the file with the use of the pendrive mass memory.

Procedure:

- Insert the pendrive mass memory into the USB port.
- Press <Export weighing base to file> field and the program will move to another window in which you have to enter export settings.

← Export weighing records database

Product Each

Operator Each

Filter by date

Data selection

Export weighing records database to a file

Print selected weighing records

In <Data selection> field, the operator can define data related to measurements to be exported.

← Data selection

Date and time

Tare

Product

Packaging

Universal variable 1

Universal variable 3

Mass

Operator

Customer

Warehouse

Universal variable 2

Universal variable 4

- Once you have set the option, click <Export weighing base to file> field and the program will start exporting the weighing base automatically.
- After you have finished exporting, you will see <Done> message together with the information on the number of data exported and file name (with *.txt extension),

and then the balance will return to the previous window.

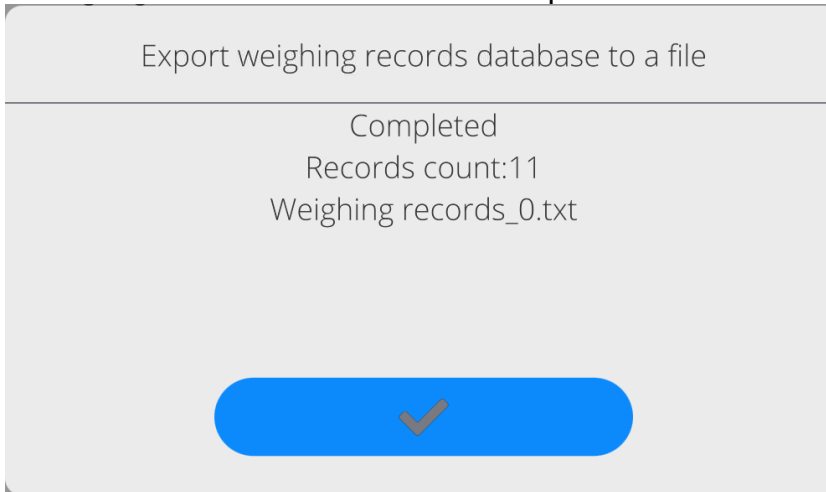

- You can return to weighing or move to further menu settings.

Note: If the balance fails to recognise the pendrive mass memory, enter <Export weighing base to file> option and the following message will be displayed: <Operation error>.

- The name of the file you have created is composed of the database name and factory number of the balance, e.g. <Weighing_364080.txt>.
- Disconnect the pendrive mass memory from the USB port of the balance.

File template:

The template of the file you create takes a form of a table whose columns are separated with a <Tab> mark in order to allow direct export of the file to <Excel> sheet. The table contains all information on the weighing, such as date and time, mass and mass unit, tare and tare unit, series number, operator's name, business partner's name, packaging name, source warehouse name, target warehouse name, result control name.

14.6.2. Delete weighing records and reports

This field is used to clear the content of the database of weighing records and reports. After activating the function, the program will display a box with numerical keypad in which you need to enter a limit date. The date specifies the limit for data deletion – older than the date you have entered. Give a year, month and day.

← Delete older than

21.07.2023

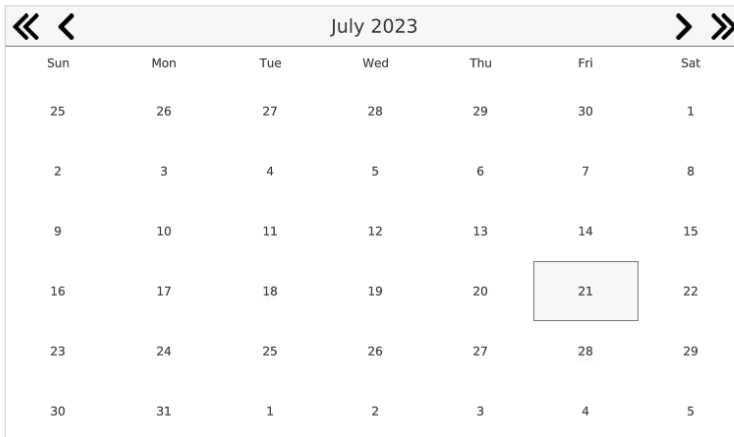

After confirming the data you have entered, all weighing records and reports collected in the specific period of time will be deleted. The quantity of deleted data will be displayed.

15. COMMUNICATION

The communication menu can be found in the parameters menu. To gain access, you need to press <Setup> key or icon. The balance can communicate with the external device through the following ports:

← Communication

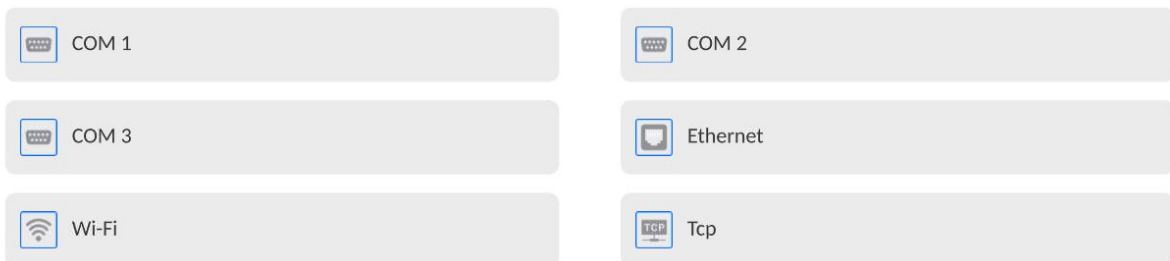

Parameters of each port can be configured as per your needs.

15.1. RS 232 ports settings

NOTE: to assure a correct cooperation with external devices, via RS 232 ports, please use a **USB-to-RS232** converter.

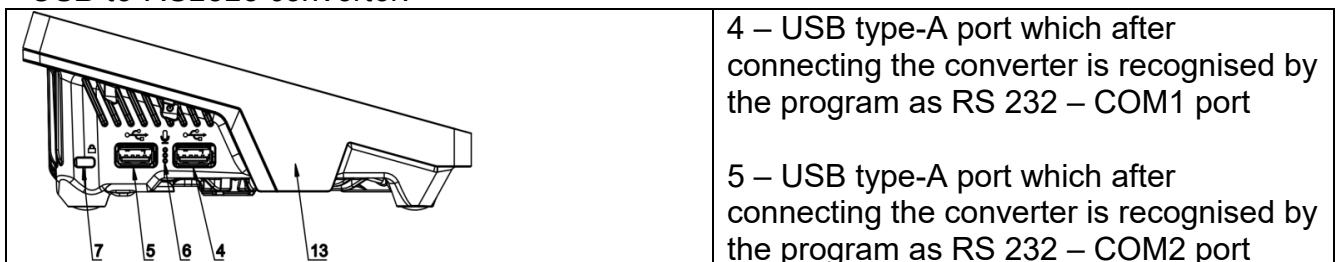

4 – USB type-A port which after connecting the converter is recognised by the program as RS 232 – COM1 port

5 – USB type-A port which after connecting the converter is recognised by the program as RS 232 – COM2 port

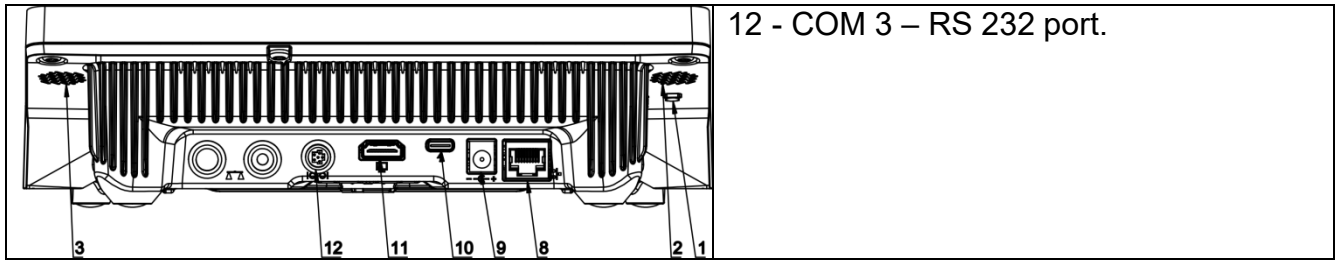

Procedure:

- Select communication port: <COM1>, <COM2> or <COM3>.
- Set respective parameters.

Transmission parameters for RS 232 ports:

- Baud rate: 4800, 9600, 19200, 38400, 57600, 115200 bit/s, 921600 bit/s*
- Data bits: 5, 6, 7, 8
- Stop bits: None, 1, 1.5, 2
- Parity: None, Odd, Even, Marker, Space

*) – Speed value available only to the COM3 port for cooperation with IM02 communication module.

15.2. ETHERNET port settings

Procedure:

- Select <Ethernet> communication port and then set relevant values:
 - DHCP: Yes – No
 - IP address: 192.168.0.2
 - Subnetwork mask: 255.255.255.0
 - Default gateway: 192.168.0.1

Note: The above-stated settings are for reference only. The transmission parameters must be selected as per the settings of the local network of the client.

After making changes, press  key. The following message will be displayed: <To make changes effective, restart the balance>.

Return to weighing and restart the device.

15.3. Wi-Fi port settings

If the balance is equipped with a Wi-Fi module, a special icon will be displayed in the home screen, in the upper bar.

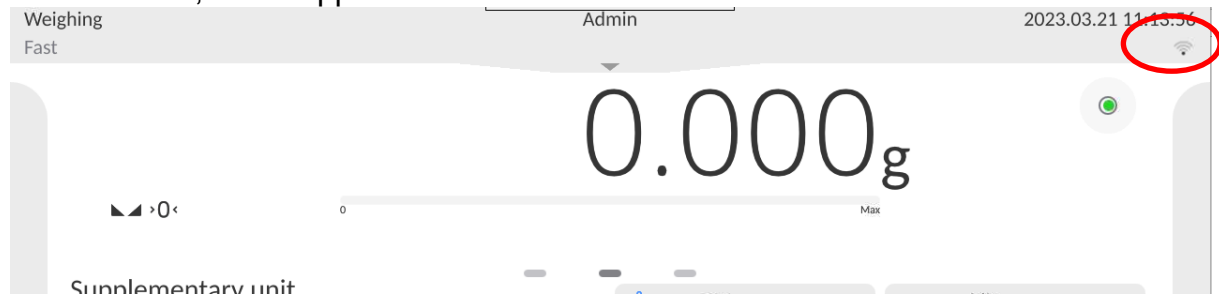

Procedure:

- Select <Wifi> communication port and then set relevant values:
 - DHCP: Yes – No
 - IP address: 10.10.9.155

- Subnetwork mask: 255.255.255.0
- Default gateway: 10.10.8.244

Note: The above-stated settings are for reference only. The transmission parameters must be selected as per the settings of the local network of the client.

After making changes, press  key. The following message will be displayed: <To make changes effective, restart the balance>. Return to weighing and restart the device.

Additionally the operator can check <Available networks> detected by the balance:

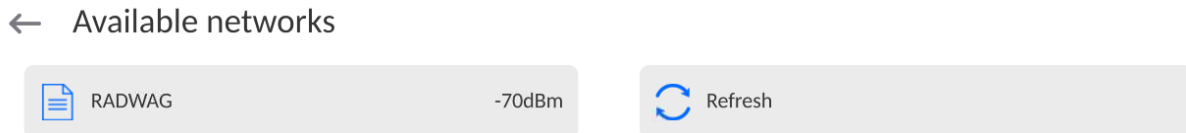

The icon next to the network name shows if the network requires a password (the icon with a lock). To find available networks, select <Refresh> option.

To check parameters of the network, press <Network status> field. The network parameters will be given in the window:

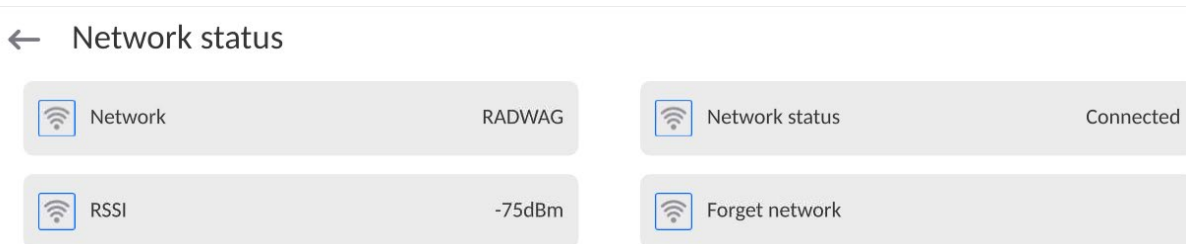

The selected network and connection parameters are remembered by the balance program. Every time you turn the balance on, the program connects to the network as per your preset parameters. To disable this function, select <Forget network> item. It will cause the connection to the specific network to be terminated.

15.3.1. General information on Hot Spot service

Hot Spot – an open access point that allows a wireless connection to the balance with the use of other device, e.g. laptop, tablet or mobile phone, via the Wi-Fi wireless network.

The Hot Spot owner decides about the method, people and terms of making his connection available through logging, which requires a unique username and password (these data are assigned while starting the balance and then stored in its memory)

15.3.2. Activation of Hot Spot service

1. Enter Wi-Fi settings

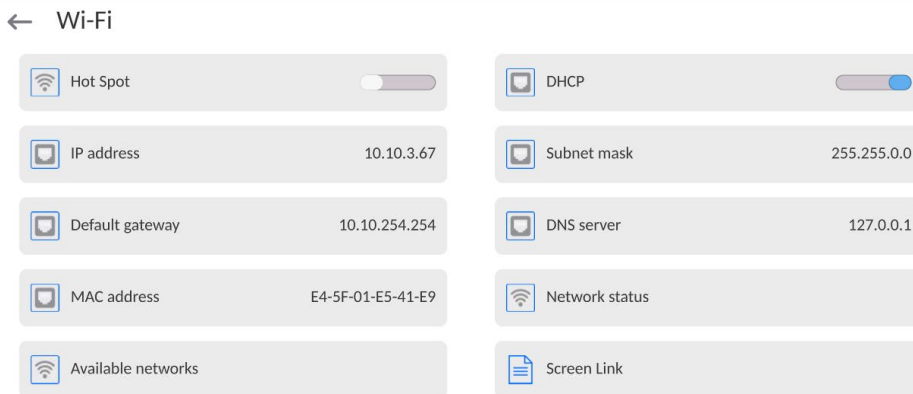

2. Activate the Hot Spot service and the balance will switch into service settings after a while.

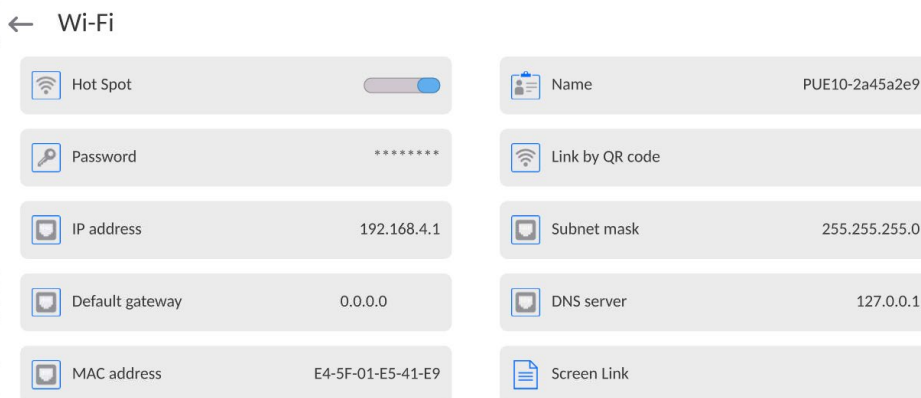
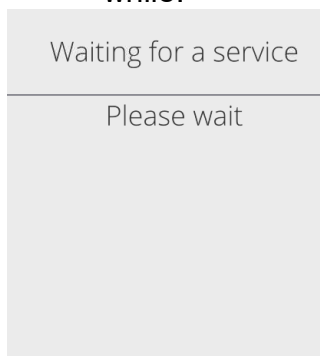

3. Enter the unique name and password (the password must contain at least 8 characters).

← Name

ELIPSIS1234



Waiting for a service

Please wait

← New password



← Repeat the new password



Waiting for a service

Please wait

← Wi-Fi

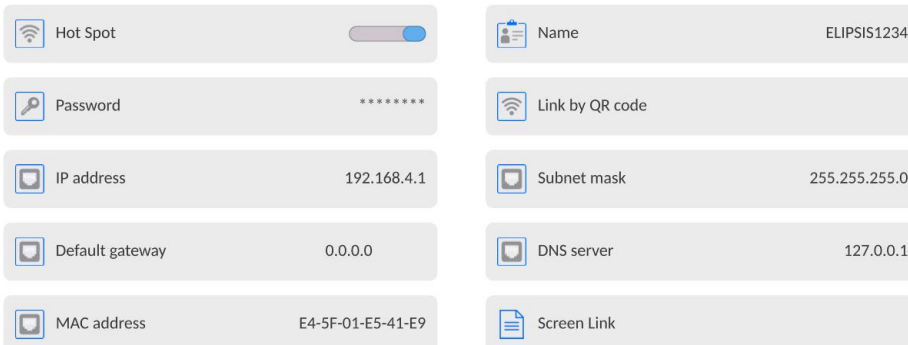

4. From now on, the Hot Spot service will be active and the created subnetwork will be recognised by other devices, such as a smartphone, under the aforesaid name, and it will be possible to connect to it with the password.

15.4. TCP protocol settings

TCP (*Transmission Control Protocol*) is a streaming communication protocol between two PCs. TCP is based on the client-service mode. The server awaits connection in the specific port, while the client initiates the connection to the server.

How to set the port number for TCP:

- Enter <Communication> parameters group.
- Select <Tcp / Port>, and you will see <Port> box with an on-screen keypad.
- Enter the desired port number and press  key to confirm.

15.5. Virtual COM Settings

Applicable in the case of an active IM02 communication module

Virtual COM is intended for connecting the scale to a computer.

Steps:

1. Enter **<Peripherals / Computer / Port>** submenu and set **Virtual COM** option.
2. Run a PC software to read measurements made with the scale.
3. Set communication parameters in the PC software, i.e.: COM port, transmission parameters.
4. Start connection.

16. DEVICES

The DEVICES menu is included in the parameters menu. To gain access, you need to press **<Setup>** icon. The menu contains a list of devices that can cooperate with the balance.

16.1. Computer

The active connection of **balance – computer** is signalled with  icon in the upper bar of the home screen.

16.1.1. Computer port

The balance can communicate with the computer via the following ports: COM 1, COM 2, Tcp, USB Free Link*.

Procedure:

- Enter **<Devices / Computer / Port>** submenu and select a desired port from the list.

*) – The description of the port can be found in the COMMUNICATION section of the manual.

16.1.2. USB Free Link

The tool used to enter data for peripherals serving as a keyboard. Thanks to this, after relevant modification of the standard or non-standard printout and sending the relevant command from the Pc or pressing ENTER key on the balance keyboard, the data included in the non-standard printout are directly transferred from the balance to such PC programs as Excel, Word, Notebook, etc.

To assure a correct cooperation with Excel, you need to configure the non-standard printout properly by inserting printout formatting marks into the printout design, for example Tab, Key keys or diacritical signs typical of a specific language. Please remember to set a correct decimal point (dot or comma) that will be accepted by our Excel program (see submenu:

< / Other / Decimal point>).

USB Free Link is a USB type-C port (port no. 10 at the back of the readout head) which the PC is connected to via the USB type-A/type-C cable.

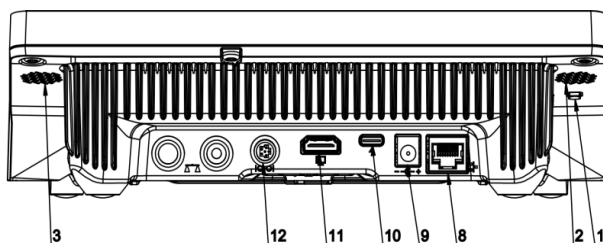

The example of the printout template and final printout in Excel:

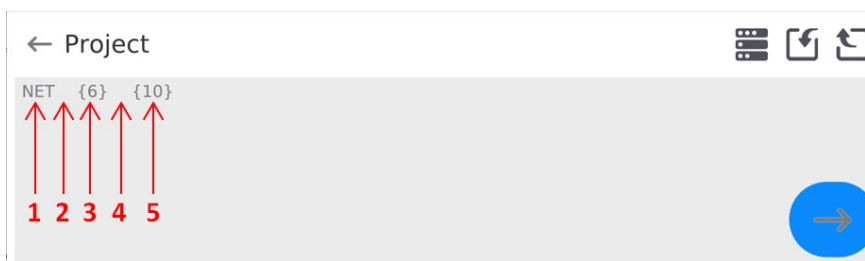

1	fixed text
2	tabulator (jump to next column)
3	variable {6}, net mass in adjustment unit
4	tabulator (jump to next column)
5	variable {10}, mass unit

	A	B	C	D	E	F	G
1							
2							
3				NETTO:	1,1235 g		
4				NETTO:	1,1455 g		
5				NETTO:	1,1258 g		
6				NETTO:	1,1325 g		

16.1.3. Computer address

Here you can set the address of the balance which the computer is connected to.

Procedure:

- Enter **<Devices / Computer / Address>** submenu and you will see **<Address>** window with an on-screen keypad.
- Enter the desired address and press  key to confirm changes.

16.1.4. Continuous transmission

Activation of balance-computer permanent transmission. After enabling **<Permanent transmission>** parameter, the content of **<Weighing Printout Template>** is continuously sent to the PC.

Procedure:

Enter **<Devices / Computer / Permanent transmission>** submenu and set relevant value ( - Permanent transmission disabled;  - Permanent transmission enabled).

16.1.5. Interval

Here you can set frequency of **<Weighing Printout Template>** printout for continuous transmission. The printout frequency can be set in seconds, with an accuracy of 0.1sec., from 0.1sec. to 1000 seconds.

Procedure:

- Enter **<Devices / Computer / Interval>** submenu to see **<Interval>** edition box.
- Enter the desired value and press  key to confirm.

16.1.6. Weighing printout template

A unique printout template. Printing from the balance to computer.

Procedure:

- Enter **<Devices / Computer / Weighing Printout Template>** submenu. You will see **<Weighing Printout Template>** edition box with an on-screen keypad.
- Modify the template and press  to confirm changes.





16.1.7. Cooperation with E2R System

Activation of cooperation between the balance and **E2R System**. The **E2R System** software is a module system that supports production processes related at various stages to weighing procedures.

	<i>Only the operator assigned with <Administrator> permission level can activate <E2R> parameter. In case of cooperating with <E2R System> PC software, database edition in the balance is blocked.</i>
---	--

Access path:  / **<Devices / Computer / E2R System>**.

The list of **<E2R System>** submenu options:

Active system	Activation of connection to E2R System :  - connection disabled,  - connection enabled. If the connection is enabled, the  icon in the top bar of the home screen will be visible.
Block product selection	Activation of product selection lock for balance operator:  - lock disabled,  - lock enabled.
Databases	Submenu with configuration of databases that cooperate with E2R System.
Info	List of database events that occur during active connection to E2R System.

16.2. Printer

<Printer> submenu allows you to:

- set port for establishing communication with a printer: COM 1, COM 2, COM3, USB, Tcp Client, USB Free Link*, RS 232 IM02**;
- define printer's code page (default: 1250),
- define control codes for PCL printer or receipt printer.

Caution: Codes must be entered in a hexadecimal form!

- define printout templates.

*) - for port description, read section COMMUNICATION of the manual.

**) - Communication ports of the scale-connected IM02 communication module.



To ensure correct balance – printer operation (correct printout of diacritical signs of a given language), respective baud rate, obligatory for a given printer, must be chosen (see the printer settings). Additionally, the code page of a sent printout must be accordant with the code page of a printer.

There are two methods for obtaining code page accordance:

by setting the right code page in printer settings (read the printer manual) – respective to the printout code page set in the balance;

Code page	Language
1250	Polish, Czech, Hungarian
1252	English, German, Spanish, French, Italian
1254	Turkish

- by sending a control code from the balance. The code sets a suitable printer code page before the printout (the same as the printout code page set in the balance) before printing data from the balance (only when the printer allows so).

	<i>A default value of the printer code page is 1250 – the Central-European code page</i>
	<i>A detailed description of the balance communication with the receipt printer can be accessed in the 'ATTACHMENTS 03' manual.</i>

USB FREE LINK – a USB type-C port (port no. 10 at the back of the readout head) which a computer is connected to via the USB type-A/type-C cable.

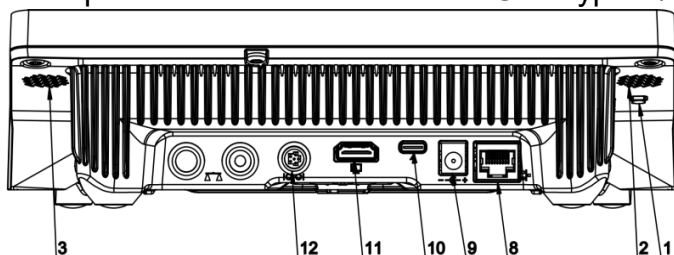

The tool used to enter data for peripheral devices that serve as a keyboard. Thanks to this, after modification of the standard or non-standard printout and sending a relevant command from the computer or pressing the ENTER key on the balance keyboard, the data included in the non-standard printout are directly transferred from the balance to such computer programs as Excel, Word, Notebook and many other.

To assure correct cooperation with Excel, you need to configure the non-standard printout by inserting the printout formatting marks, for example Tab, Enter keys and diacritical signs typical of the specific language. Please remember to set a correct decimal point sign (dot or comma) that will be accepted by our Excel. It can be set in the parameters: *Setup/Other/Decimal point*.

See below for the example of the printout template and final printout in Excel:

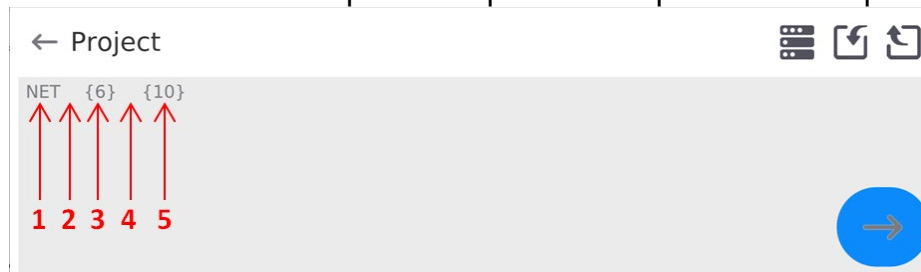





1	fixed text
2	tabulator (jump to next column)
3	variable {6}, net mass in adjustment unit
4	tabulator (jump to next column)
5	variable {10}, mass unit

	A	B	C	D	E	F	G
1							
2							
3				NETTO:	1,1235	g	
4				NETTO:	1,1455	g	
5				NETTO:	1,1258	g	
6				NETTO:	1,1325	g	

 **If you intend to use Free Link to print out data with a big amount of information, you need to set the value of 15 in <Receipt Printer Speed [marks/second]> parameter.**

← Printer

 Port COM 1	 Code page 1250
 Control codes	 Receipt printer speed [character/second] 0
 Printouts	

The printout template is a description of how the information from the database is to be printed out. If it is insufficient, it must be modified. Correctness of the designed template can be checked by printing product-related parameters. The operation is feasible after entering <Products/Product edition> database – press the printer icon.

Default values for particular templates:

Product Printout Template:

{50}
{51}

Operator Printout Template:	{75}
	{76}
Customer Printout Template:	{85}
	{86}
Warehouse Printout Template:	{130}
	{131}
Packaging Printout Template:	{80}
	{81}
	{82}
Environmental Conditions Printout Template:	{275}
	IS T1: {278} °C
	IS T2: {279} °C
	THB T: {276} °C
	THB H: {277} %
Formula Printout Template:	{165}
	{169}
Pipette Printout Template:	{310}
	{311}

16.3. Barcode scanner

The balance can cooperate with a barcode scanner. The scanner can be used for quick search of the following:

- Products,
- Operators,
- Customers,
- Packaging,
- Warehouses,
- Formulas,
- Pipettes,
- Series in differential weighing
- Universal variables,



In <Communication> submenu, set the transmission speed that complies with the barcode scanner (by default 9600b/s). A detailed description of the communication between the balance with barcode scanners can be found in the 'ATTACHMENTS 03' of the manual.

You can configure the barcode scanner in the submenu:

'Setup / Devices / Barcode Scanner'.

16.3.1. Barcode scanner port

Procedure:

- Enter <Devices> parameters group and select <Barcode Scanner / Port>, and then set a suitable option.

The balance can communicate with the scanner via the port:



- USB

16.3.2. Prefix / Suffix

The operator can edit the value of <Prefix> prefix and <Suffix> suffix in order to synchronise the weighing program with the barcode scanner.

Note: In the standard adopted by RADWAG, the prefix is a mark (byte) 01 hexadecimally and the suffix is a mark (byte) 0D hexadecimally. A detailed description of the communication between the balance and barcode scanners can be found in the **ATTACHMENT E** of the manual.

Procedure:

- Enter <Barcode Scanner> submenu,
- Enter <Prefix> parameter and use the on-screen keyboard to enter the desired value (hexadecimally) and then press  key to confirm changes.
- Enter <Suffix> parameter and use the on-screen keyboard to enter the desired value (hexadecimally) and then press  key to confirm changes.

16.3.3. Field selection

The operator can configure the field selection in particular databases, which the search is to apply to.

Procedure:

- Enter <Devices> parameters group,
- Select <Barcode Scanner / Field selection> to display the following list:

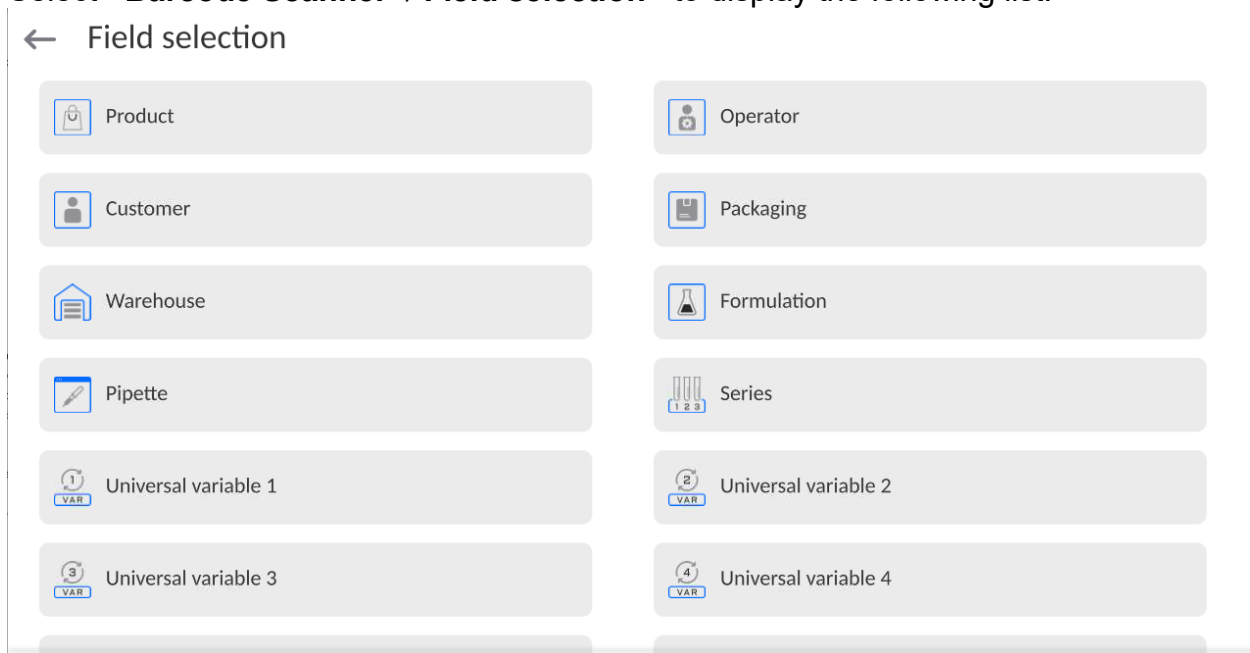

- Enter the desired item to be able to edit the following parameters:

Filtering	Declare the item in which the search is to apply to (see table below)
Offset	Set the first significant code mark from which you wish to start searching. All preceding marks are skipped
Code Length	Set the number of code characters considered for searching
Start Marker	Declare the start of the scanned code that will be considered for searching

End Marker	Declare the end of the scanned code that will be considered for searching
Skip Marker	Declare if you wish to include start and end markers while comparing the scanned code with the balance code.

The list of filtering items, depending on the field selection:

Field selection	Filtering
Product	None, Name, Code, EAN Code,
Operator	None, Name, Code
Customer	None, Name, Code
Packaging	None, Name, Code
Warehouse	None, Name, Code
Formula	None, Name, Code
Pipette	None, Name, Code
Series	None, Name, Code
Universal variables	None, Active

16.3.4.Test

Using **<Test>** function, the operator can verify the correct operation of the barcode scanner connected to the balance.

Procedure:

- Enter **<Barcode Scanner>** submenu,
- Enter **<Test>** parameter and you will see **<Test>** window with the ASCII and HEX windows,
- After scanning the code, it will appear in ASCII and HEX fields. The test result will be displayed in the lower part of the box.

When:

- **<Prefix>** and **<Suffix>** declared in the balance settings comply with **<Prefix>** and **<Suffix>** in the scanned code, the test result will be **<Positive>**,
- **<Prefix>** and **<Suffix>** declared in the balance settings do not comply with **<Prefix>** and **<Suffix>** in the scanned code, the test result will be **<Negative>**.

16.4. Environmental module



It is possible to connect the THB environmental module to the balance through UDP or USB ports. In order to assure correct cooperation, you need to select a suitable environmental module connection port.

16.5. IM02 communication module

The IM02 communication module allows the scale to cooperate with such accessories as printers, control keys, stack lights, buzzers, PLC controllers, as well as other control-signalling devices and PCs.

	<i>The procedure of connecting the IM02 communication module to the supply network and scale has been described in detail in the 'IM02 communication module' manual.</i>
---	---

16.5.1. Activation of IM02-to-scale connection

- Connect the IM02 communication module to the COM3 port of the scale.
- Connect the IM02 communication module to the supply network.
- Enter **<Peripherals / IM02 communication module / Active>** submenu and enable IM02 communication module ( - module active,  - module inactive).
- Once the IM02 communication module has connected to the scale, the following information will be automatically displayed:

Status	Active connection status, the status takes the following values: Connected, Not connected.
Software rev.	Software version of the IM02 communication module.
Manufacture variant	IM02 communication module manufacture version.

- Simultaneously the scale menu is extended to include **<Inputs / Outputs>** submenu and list of available communication ports in the **<Communication>** submenu.

17.INPUTS / OUTPUTS

Applicable in the case of an active IM02 communication module

The PUE CY10 meter can support **4 inputs / 4 outputs** via connection to the IM02 communication module.

Access path:  / **Inputs/Outputs**.

17.1. Input Setup

- Enter **<Inputs/Outputs>** submenu.
- Select **<Inputs>** parameter, list of available inputs is displayed.
- Edit selected input, list of functions to be assigned is displayed. Input functions list is identical like key functions list, read section 21.2.
- Select the function you want to assign to the input, next go back to the home screen.

	<i>By default all functions are assigned with <None> value.</i>
---	--

17.2. Output Setup

Output gets activated at the moment of assigning it with a given function. Unassigned outputs remain inactive.

Procedure:

- Enter **<Inputs/Outputs>** submenu.
- Select **<Outputs>** parameter, list of available outputs is displayed.
- Edit selected output, list of functions to be assigned is displayed.

None	Output inactive.
Stable	Stable weighing result over LO threshold value.
MIN stable	Stable weighing result below the MIN threshold.
MIN unstable	Unstable weighing result below the MIN threshold.
OK stable	Stable weighing result between MIN and MAX thresholds.
OK unstable	Unstable weighing result between MIN and MAX thresholds.
MAX stable	Stable weighing result over the MAX threshold.
MAX unstable	Unstable weighing result over the MAX threshold.
! OK stable	Stable weighing result out of OK threshold.
! OK unstable	Unstable weighing result out of OK threshold.
MIN	MIN threshold signalling.
OK	OK threshold signalling.
MAX	MAX threshold signalling.
! OK	Signalling of weighing result out of OK threshold.
Zero	Zero weighing result („zero” marker).

- Select the function you want to assign to the output, next go back to the home screen.

	<i>By default all functions are assigned with <None> value.</i>
---	--

18. OTHER PARAMETERS

This menu contains global information on operation of the balance, such as language, date – time, sound signal, screen calibration, level control. To enter <Other> submenu, press the Setup key and then <Other> key.

18.1. Interface language selection

Procedure:

Enter <Other> submenu, select <Language> and choose the communication interface language of the balance.

Available languages: Polish, English, German, French, Spanish, Korean, Turkish, Chinese, Italian, Czech, Romanian, Hungarian, Russian, Serbian.

18.2. Date and time settings

The operator can set the date and time as well as select the data display and printout format. You can edit date and time settings in two ways:

- press <Date and time> field, available in the upper bar of the home screen,
- enter <Setup / Other/ Date and Time> submenu.

After entering the date and time settings edition box, you will see an on-screen keypad. Set relevant values: year, month, day, hour, minute and confirm changes.

← Date and time

24.07.2023 13:16:15

July 2023						
Sun	Mon	Tue	Wed	Thu	Fri	Sat
25	26	27	28	29	30	1
2	3	4	5	6	7	8
9	10	11	12	13	14	15
16	17	18	19	20	21	22
23	24	25	26	27	28	29
30	31	1	2	3	4	5

hh	:	mm	:	ss
09	:	10	:	11
10	:	13	:	12
11	:	14	:	13
12	:	15	:	14
13	:	16	:	15
14	:	17	:	16
15	:	18	:	17
16	:	19	:	18
17	:	20	:	19

→

The <Setup / Other/ Date and Time> submenu contains additional functions used to define date and time format:

Name	Value	Description
Time zone	Europe, Warsaw	The parameter for the value: name of zone/country. The specific name of the zone/country is related to the information whether the time changes from the winter to summer (and the other way round), and specific day of the year in which the change occurs.

Date and time	2016.04.04 08:00:00	Here you can set the date and time of the internal clock of the balance.
Date format	yyyy.MM.dd *	Select the date format. Available values: d.M.yy, d/M/yy, d.M.yyyy, dd.MM.yy, dd/MM/yy, dd-MM-yy, dd.MM.yyyy, dd/MM/yyyy, dd-MMM-yy, dd.MMM.yyyy, M/d/yy, M/d/yyyy, MM/dd/yy, MM/dd/yyyy, yy-M-dd, yy/MM/dd, yy-MM-dd, yyyy-M-dd, yyyy.MM.dd, yyyy-MM-dd.
Time format	HH:mm:ss **	Select the time format. Available values: H.mm.ss, H:mm:ss, H-mm-ss, HH.mm.ss, HH:mm:ss, HH-mm-ss, H.mm.ss tt, H:mm:ss tt, H-mm-ss tt, HH.mm.ss tt, HH:mm:ss tt, HH-mm-ss tt, h.mm.ss tt, h:mm:ss tt, h-mm-ss tt, hh.mm.ss tt, hh:mm:ss tt, hh-mm-ss tt
Hide time	No	Enable/disable the date and time visibility in the home screen.
Internet time	Yes	If the balance is connected to the web network, this option allows updating the time and date from the network.
Synchronised with Internet	Yes	This parameter informs the operator if the time and date in the balance have been synchronised with the data in the online network.

*) - For date format: y – year, M – month, d – day

***) - For time format: H – hour, m – minute, s – second

The date and time preview with special regard to declared formats is visible in <Date and Time> field.

← Date and time

The screenshot displays the 'Date and time' settings interface. It consists of several rows, each with a clock icon, a label, and a value or toggle:

- Time zone:** Europe/Warsaw
- Date and time:** 2023.03.23 10:17:45
- Date format:** yyyy.MM.dd
- Time format:** HH:mm:ss
- Hide time:** A toggle switch is currently turned off.
- Time from the Internet:** A toggle switch is currently turned on.
- Synchronized with the Internet:** A toggle switch is currently turned on.

Note: The access to <Date and Time> parameters settings is given only to the operator assigned a relevant permission level. The permission level can be modified by the administrator in <Permission> menu.

18.3. Extension module

The option allowing you to activate the device compliance for FDA 21 CFR procedures, extension of the communication protocol in the balance and deactivation of the standard balance license (the so-called demo balance).

To activate it, you need to know the license number for particular options. To obtain this number, you have to contact the device manufacturer.

Procedure:

Enter <Other> submenu, select <Extension module> parameter and follow the messages displayed.

18.4. Sound

Procedure:

Enter <Other> submenu, select <Sound> parameter and set a relevant option:

- | | |
|-----------------------|---------------------------|
| Result approval sound | – Yes/No |
| Touch screen sound | – Yes/No |
| Sensors | – Yes/No |
| Volume | – volume range up to 100% |

18.5. Visual result approval

The option allowing you to visually confirm that the measurement has been recorded in the weighing base. After setting <  >, every recorded measurement will be communicated to the operator through temporary blue illumination of the mass display.



18.6. Screen saving

The operator can activate the screen saving procedure.

To do so:

Press the Setup key and then: <Other/Screen saving>.

After entering the edition box, you can select one of the following values: [None; 1; 2; 3; 5; 10; 15]. Digital values are set in minutes. Selection of one of the values causes automatic selection of this specific value and return to the previous menu.

Note:

The screen is saved only when the balance is not used (no changes to the mass in the screen). Return to weighing after the screen is saved occurs automatically when the program can detect any change to the mass or when you press the screen or the button on the housing.

18.7. Screen brightness

The screen brightness has an impact on the length of balance operating time in case of battery powering. If you wish to prolong the time between subsequent battery charging cycles as much as possible, you can reduce the screen brightness.

In so doing:

Press the Setup key and then: <Other/Screen brightness>.

After entering the edition box, enter the value in the following range: [0% - 100%]. When you enter a relevant value, you instantly change the screen brightness and return to the previous menu.

18.8. Vibration detection

The balance program allows detecting wrong placement of the sample on the weighing pan, which may lead to increased value errors. The function is active when the relevant icon shows up on the mass display.

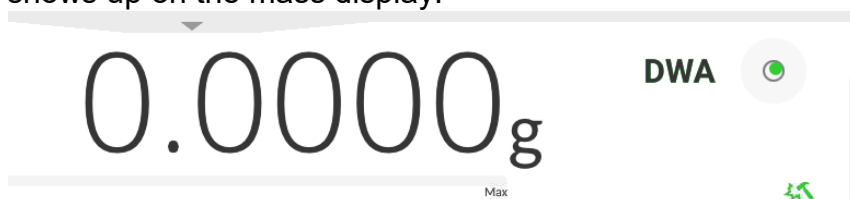

If the balance program can detect wrong placement of the sample on the weighing pan, the icon turns red - . This means that the result can be subject to a greater margin of error.

Procedure:

- Enter <Other> submenu.
- Select <Vibration detection> parameter,
- Select one of the options:
 - Yes – active function
 - No – inactive function

18.9. Level control

The balance is equipped with the Automatic Level Control function.

In the case of non-verified balances, you can define the method of its operation.

In the case of verified balances, settings are invisible and comply with the factory set values, that is: <Active with lock>, weighing is possible only when the balance is levelled.

Procedure:

- Enter <Other> submenu.
- Select <Level control> parameter and the edition box will be displayed.
- Select one of the following options:
 - None – the level indicator is not displayed, the balance does not control level,
 - Active – the level indicator is displayed, the balance shows the level change through a change of colour (green → OK, red → level is lost),
 - Active with lock – the level indicator is displayed, the balance shows the change of the level through a change of colour (green → OK, red → level is lost; when the indicator is red, the display shows the following message – no Level -, weighing is not possible).

Note: The method of levelling is described in the point 13.3 of the manual.

18.10. Decimal point

This parameter allows you to select the decimal point in the mass printout.

Procedure:

- Enter <Other> submenu.
- Select <Decimal point> parameter and the edition box will open.
- Select one of the following options:
 - Dot
 - Comma

Select the value to return to the submenu box.

18.11. Sensors sensitivity

This parameter ranges from 0 to 9 and determines the distance of reaction of the sensors. By default the value ranges from 5 to 7.

Procedure:

- Enter <Other> submenu.
- Select <Sensors sensitivity> parameter and the edition box will be displayed.
- Select one of the values. Select the value to return to the menu window.

18.12. Door opening

This parameter allows you to set the range of door opening in case of automatic operation. By default this value is <100%>, which means that the door is fully open.

Procedure:

- Enter <Other> submenu.
- Select <Door opening degree> parameter and the settings selection box will pop up.
- Select the desired value <75%>.
- Next confirm the settings to return to the menu window.

18.13. Automatic ionisation

This parameter allows you to disable ionisation or select its level. The values you can choose: None/Low/High/Continuous operation.

Procedure:

- Enter <Other> submenu.
- Select <Automatic ionisation> parameter and the settings selection box will pop up.
- Enter the desired value <Low>.
- Next confirm your settings to return to the menu window.

18.14. Autotest

The <AUTOTEST> function is used to help the operator evaluate work and diagnose causes of weighing errors that exceed permissible values for the specific type of balance. AUTOTEST allows regular optimisation of the balance settings in order to obtain the best repeatability parameters and weighing time in the specific working environment. The function also lets you check the above-stated parameters at any time, as well as archive the test you have completed.

The function is divided into two modules:
AUTOTEST FILTER; AUTOTEST GLP.

Before any test is carried out, the balance checks levelling, temperature and humidity.

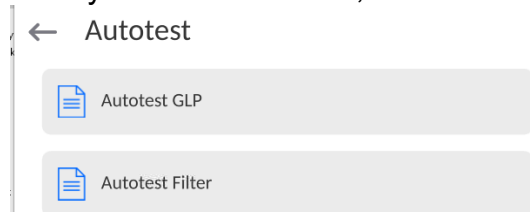

AUTOTEST FILTER

In this procedure, the internal weight is applied and removed 10 times for all possible filter set points and result is confirmed. 2 parameters are checked under the procedure: Repeatability and Weighing Result Stabilisation Time.

The entire test takes about 1 hour. Once the test has been conducted for all potential set points, the display shows results.

The operator is informed which settings in the specific environment are the most optimal for the balance parameters.

This function proves very useful and allows you to obtain the best possible accuracy of weighing and the shortest weighing time with the repeatability value that is accepted by the customer.

The results are remembered by the balance upon its activation.

The function allows printout through printers available in the system and quick selection of the most optimal settings directly from the options level.

After the end of the autotest, a summary and results are displayed.

The program automatically selects the filter settings by displaying a suitable icon by results:

- settings with the fastest measurement (the shortest measuring time).
- settings with the most accuracy measurement (the smallest deviation for 10 measurements).
- settings with the optimal measurement (the lowest product of time and deviation).

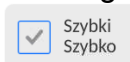

- current filter settings.

Measurement results:

- *Type of filter.
- * Parameter value <Result approval>.
- * The value of result repeatability expressed as a standard deviation.
- * Average time for result stabilisation.

The example view of the results window can be found below:



<input type="checkbox"/> Very fast Fast	<input type="checkbox"/> Very fast Fast and reliable
<input type="checkbox"/> Very fast Reliable	<input checked="" type="checkbox"/> Fast Fast
<input type="checkbox"/> Fast Fast and reliable	<input type="checkbox"/> Fast Reliable
<input type="checkbox"/> Normal Fast	<input type="checkbox"/> Normal Fast and reliable
<input type="checkbox"/> Normal Reliable	<input type="checkbox"/> Slow Fast
<input type="checkbox"/> Slow Fast and reliable	<input type="checkbox"/> Slow Reliable

Example of the report:

```

----- Autotest Filter: Report -----
Balance type           XA 5Y
Balance ID             442566
Operator               Hubert
Application version    NL1.6.5 S
Date                   2015.05.07
Time                   09:34:48
-----
Balance readout unit   0.0001/0.0001 g
Internal weight mass   148.9390 g
Temperature: Start     25.26 °C
Temperature: Stop      25.66 °C
-----
Filter                  Very fast
Result approval         Fast
Repeatability           0.0042 g
Stabilisation time     4.505 s

Filter                  Very slow
Result approval         Accurate
Repeatability           0.0207 g
Stabilisation time     5.015 s

Signature
.....
    
```

Procedure:

After activating the function, the program instantly initiates the procedure and the window show up on the screen. The window informs the operator about the progress. When the autotest is finished, the program displays the summary together with current filter settings. The operator is allowed to print it out.

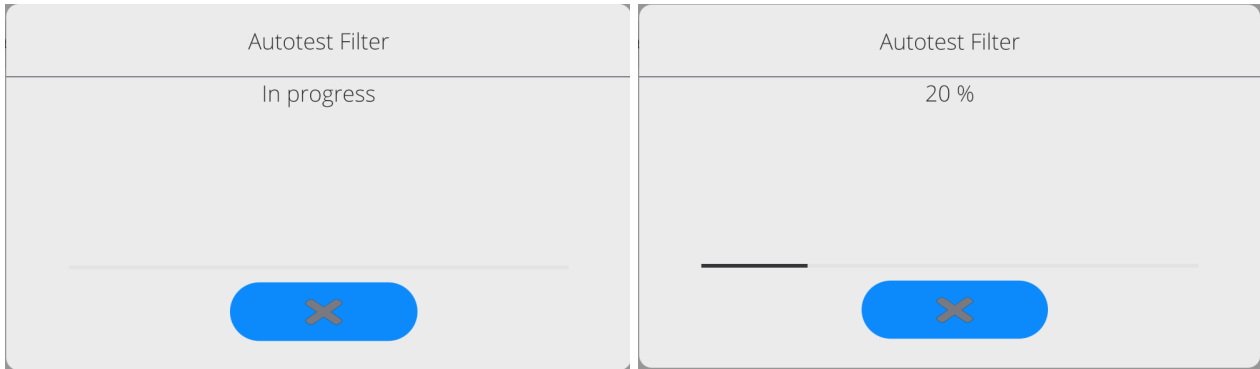

At any time the operator can abort the procedure by pressing <X> key in the window.

AUTOTEST GLP

This test checks repeatability of applying the internal weight and determining the balance readout error with reference to its maximum loading capacity.

Under the procedure, the following happens:

- the internal weight is applied twice, and then this weight is applied 10 times,
- the balance is calibrated,
- the standard deviation is calculated and remembered,
- the door test is also carried out in balances with automatically opened doors.

The function also allows displaying and printing the report through printers available in the system and archiving the report which contains basic balance data, information on environmental conditions and test results.

Test results:

*The deviation for the maximum load.

*The value of result repeatability expressed as a standard deviation.

*Door assessment (positive/negative) – if the balance is equipped with the door opening mechanism.

Example of the report:

```

.....
----- Autotest GLP: Report -----
Balance type           XA 5Y
Balance ID             400010
Operator               Admin
Application version    LLx.x S
Date                   2021.01.16
Time                   09:17:16
-----
Number of measurements 10
Balance readout unit   0.0001 g
Internal weight mass   140.094 g
Filter                 Average
Result approval       Fast and precise
-----
Deviation for Max.     -0.0118 g
Repeatability          0.00088 g
Signature
.....

```

Procedure:

Press the field with the name and the program will display a dialogue box.

From here, you can take the following actions:

- Start another AUTOTEST GLP.
- Preview autotest results and export all saved results into a *.csv file.
- Delete all saved results.

At any time the operator can abort the procedure by pressing <X> key in the window.

The autotest results are displayed in the form of a table (every line includes date and time of the autotest and results).

To display the autotest data, press a specific line of the table with results.

To print out results of the single autotest, enter the results with all data on the autotest, and generate the content printout by pressing <Printout> key in the upper bar of the display.

The results can be exported by pressing an export field in the window with all saved autotests. The data will be sent to the external memory (pendrive) as a *.csv file.

18.15. Start-up logo

(The option is available to the authorised operator only).

This parameter allows you to change the image showed in the screen while launching the device system.

18.16. System events export

(The option is available to the authorised operator only).

This option allows you to generate a special file which is saved automatically, after you run the option, to the external memory (pendrive) inserted in the USB port. This file is used to diagnose potential problems related to operation of the device by RADWAG service technicians.

Procedure:

- Insert the pendrive memory stick into the USB port.
- Next enter <Other> submenu.
- Select <System events export> parameter.
- The program will generate a special file and save it automatically on the pendrive stick.
- Such a file must be sent to RADWAG.

18.17. Text-to-speech conversion



This parameter allows you to convert names of particular groups and menu parameters into speech emitted from the measuring head speakers.







The voice that is emitted is available in English only.

19. SCHEDULED TASKS

This menu contains settings that allow you to schedule recurring tasks, such as balance calibration or display of a special message.

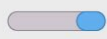
19.1. Balance calibration

← Edit record  



 Name	 Code
 Planned operation Automatic adjustment	<input checked="" type="checkbox"/> Active 
 First operation date and time 2023.03.23 12:08:46	 Interval 24 h
 Message	







<Scheduled calibrations> parameter lets you declare the exact time and interval for call of balance calibration. This option is independent of automatic calibration and call criteria (time, temperature). You can schedule the internal and external calibration. To make sure the external calibrations are scheduled, you can also export standard weights to the balance memory and use them for the purposes of calibration.

Setting:

Before you schedule the calibration, you need to enter standard weights together with their data for external calibrations.



To do so, enter the operator's menu, and <Calibration> parameters group and find <Calibration weights> and enter the weight by giving its data:



← Edit record  







 Name ETALON 100 g	 Code 1234
 Class E2	 Serial number 654321
 Mass 100 g	 Set number KP 01

Weighing Admin 2023.03.23 12:12:37

Fast

← Scheduled tasks  

← Edit record  

 Name	 Code
 Planned operation Automatic adjustment	<input checked="" type="checkbox"/> Active 
 First operation date and time 2023.03.23 12:08:46	 Interval 24 h
 Message	

Go to the operator's menu, to <Scheduled tasks> parameters group. The window will be displayed. In the window, the authorised operator (Administrator) can add items with scheduled calibrations.

To do so, click  key and the box with scheduled balance calibration data will be displayed.

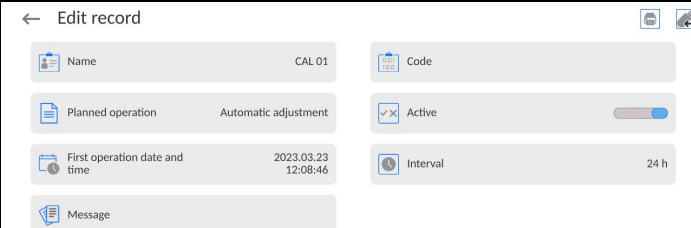
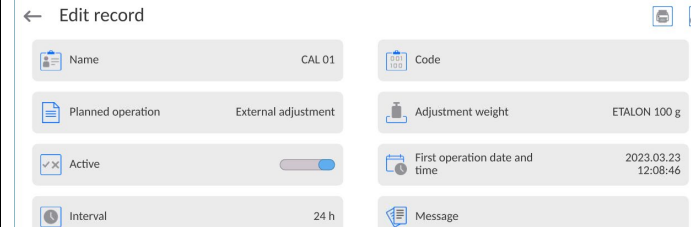
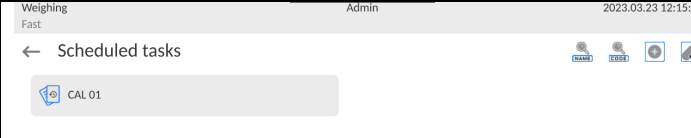

	Select the scheduled task: automatic (internal) calibration or external calibration.
	If you have selected the automatic calibration, you need to enter its data and its operation schedule.
	If you have selected the external calibration, you need to enter the calibration data, standard weight used to make it and its operation schedule.
	After entering the data, return to the previous window. An item with the schedule balance calibration will be added.



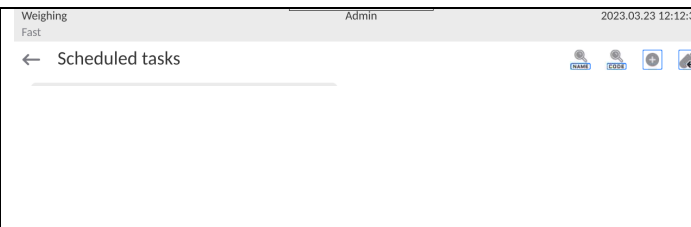

Once all data have been entered, leave the menu.

From now on, calibrations will be performed automatically: at a schedule time and with intervals entered.

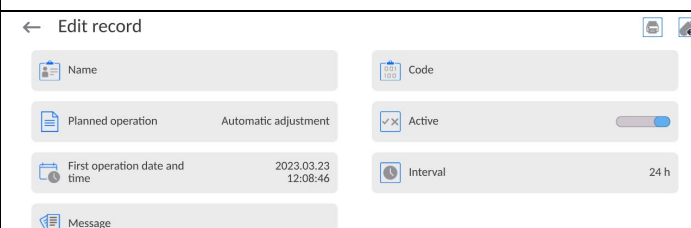
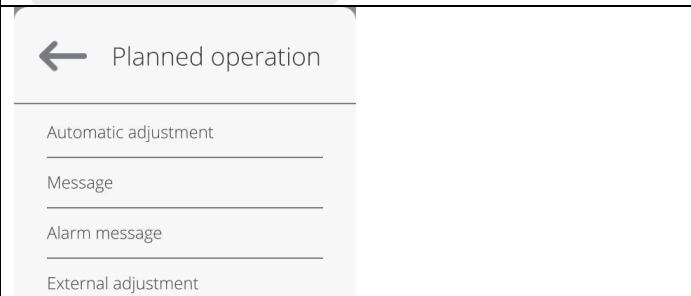
19.2. Message

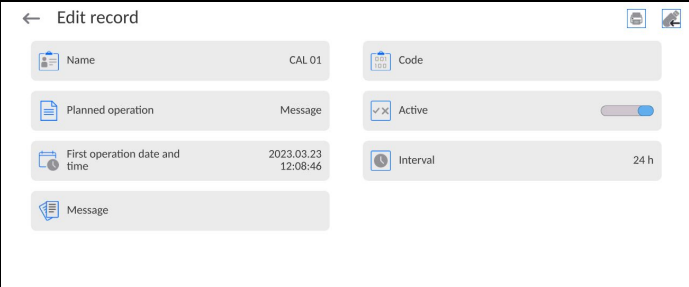
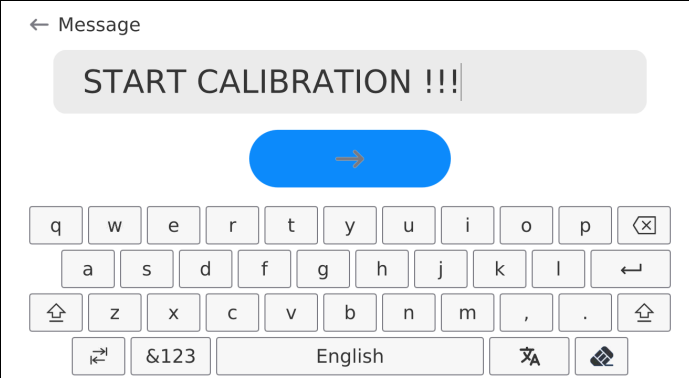
This parameter allows you to declare the exact time and interval for displaying a special message that informs the operator about a need to take some action at a specific time.

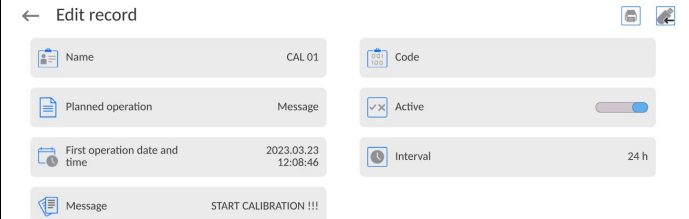
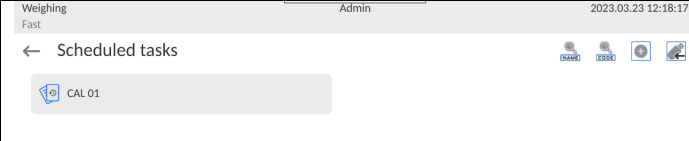
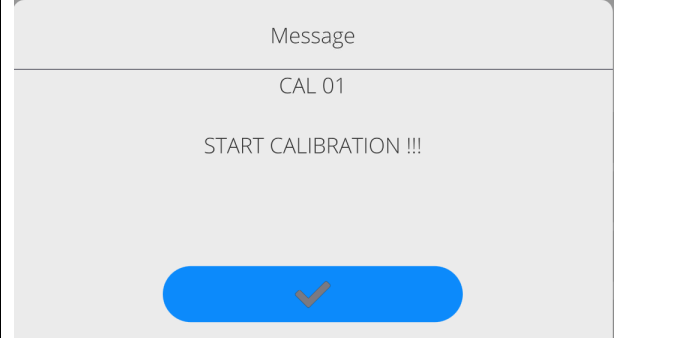
	<p>Enter the operator's menu and go to <Scheduled tasks> submenu.</p> <p>To add a task, you need to press <> key in the upper information bar.</p>
	The window will be displayed. In the window, select <Scheduled tasks> field. The option selection box will pop up.
	Select <Message> item.

	<p>The program will return to the message settings window. After setting the message display frequency options (the first display, interval), enter the content of the message after selecting <Message> lb <Message with alarm> parameter.</p>
	<p>After you have entered the content, confirm the entry by pressing <  > key.</p>
	<p>After approving, the program will return to the previous box.</p>
	<p>In the submenu window you will see a field with the scheduled task. Leave the menu and go to the home screen.</p>
	<p>When the message display criteria (time) have been met, the window with a message will pop up instantly. Press <  > key to close the window and perform the scheduled task.</p>

20. ENVIRONMENT

By default mass comparators are equipped with internal environmental conditions sensors that record environmental conditions inside the comparator, and optionally with an external sensor – THB environmental module that records environmental conditions of the comparator weighing chamber space:

- Internal sensor: Temperature 1
- Internal sensor: Temperature 2
- Internal sensor: Humidity
- *External sensor: THB environmental module

*The external sensor is delivered upon the customer's special order.

In the Environmental group, you can modify the following parameters of environmental conditions:

- Conditions record frequency
- Environmental module

Procedure

Enter <Parameters> and select <Environment> group.

Enter <Conditions record frequency> and specify the interval time for environmental conditions recording.

The operator can browse the environmental conditions record history. All these records can be found in <Database> in <Environment> base.

Enter <Environmental module> item and assign it environmental conditions parameters.

<Environmental module> Termo-Higro-Barometr (THB) records 2 types of environmental conditions:

- Temperature
- Humidity

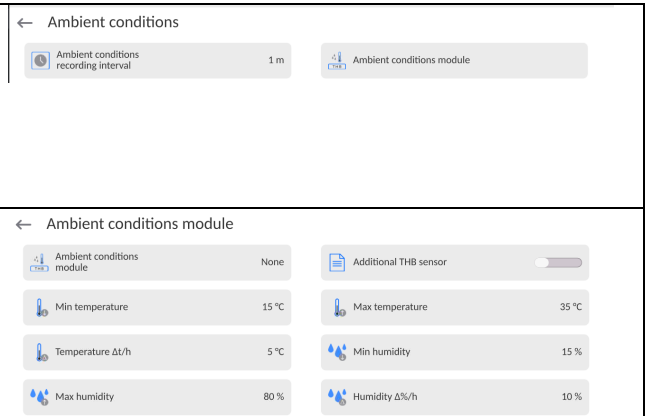

Note:

The environmental conditions for the mass comparator, set by the operator, should not deviate from the device operation tolerance specified in the product catalogue sheet. If the environmental conditions of the device differ from the ones recorded in the catalogue sheet, the device may operate in a wrong way.



21. UPDATE

It contains the following module which you can use to update the following:

- The field related to the operator: APPLICATION.
- Motherboard (administrator only).

The update is automatic and involves collection of the information from the USB external memory.

Procedure:

- Prepare a USB flash drive with the update file. Required file extension: *.lab4.
- Connect the USB flash drive to the USB port of the indicator.
- Log in as the Administrator.
- Press  button to enter the balance menu.
- Select <Update>  option.
- Select <Application> field.













- The display previews the content of the USB flash drive; search for the update file and press its name.
- The balance is automatically restarted, and the balance application is automatically updated.
- If the balance does not restart, force it to restart by turning it off and on again.

Update of the main board file is analogous; required file extensions are: *.cm4mbu – main board.

22. SYSTEM INFO

This menu contains information on the balance and installed programs. Most of the parameters are for reference only.

← About

 Balance S/N	0	 Balance type	XAM 3Y
 Network balance name	PUE10-2a45a2e9	 Software version	LL2.0
 Product code	000700404070	 Weighing firmware version	1.0.0
 Product code 2	429048443000	 Software rev. MB	1.1.3
 System version	LX-23.03.21	 CPU Id:	48560360
 Licence Id:	E4-5F-01-E5-41-E8	 Memory status	FLASH: 57 % RAM: 16 %

In <Environment> parameter, you can see the environmental parameters: temperature, humidity, pressure (when the balance is supplied with relevant sensors). After selecting <Settings printout> parameter, you will send the balance settings (all parameters) to the printer.

23. COMMUNICATION PROTOCOL



A detailed description of the balance-computer communication protocol can be accessed in the 'CBCP-07' manual.

23.1. Manual printout/automatic printout

You can generate manual or automatic printouts in the balance:

- Manual printout: press  key when the result has stabilised.
- Automatic printout is generated automatically, as per settings, as in the automatic printout (see: point 12.5).

The content of the printout depends on the settings for <Standard Printout> - <Weighing printout template> (see: point 12.5.).

Mass printout format:

1	2	3	4 -12	13	14	15	16	17	18
stability mark	space	mark	mass	space	unit			CR	LF

Stability mark [space] if stable
 [?] if unstable
 [!] if the air displacement compensation feature is active
 [^] if out-of-range error + occurs
 [v] if out-of-range error - occurs

Mark [space] for positive values or
 [-] for negative values

Mass 9 marks with a dot and right justification

Unit 3 marks with left justification

Example:

----- 1 8 3 2 . 0 _ g _ _ CR LF – printout generated in the balance

after pressing  key in settings for <Weighing printout template>:

N (number of measurements)	NO	Universal variable 1 ... 5	NO
Date	NO	Net	NO
Time	NO	Tare	NO
Levelling	NO	Gross	NO
Customer	NO	Current result	NO
Warehouse	NO	Additional unit	NO
Product	NO	Mass	YES
Packaging	NO	Non-standard printout	NO

24. CONNECTION OF PERIPHERALS

The 5Y-series balance can cooperate with the following devices:

- computer,
- EPSON receipt printer,
- printer that supports PCL6 (*Printer Command Language*),
- barcode scanner,
- fingerprint scanner,
- any peripheral device that supports ASCII protocol.

Note: You can only connect accessories listed on the RADWAG's website to the balance.

25. ERROR MESSAGES

Max weighing threshold exceeded
Unload the weighing pan

Min weighing threshold exceeded
Install weighing pan

Zeroing out of range
Press tarring button or restart the balance

Display capacity out of range
Unload the weighing pan

Tarring out of range
Press zeroing button or restart the balance

Start mass out of range
Install weighing pan

Zeroing/tarring time out of range
Weighing indication unstable

-no level- Balance not levelled

-Err 100- Weighing module restart

In process An ongoing process in the course of which the indication may be unstable (automatic feeder – the process of feeding a pill, or mass comparator – the process of load change)

26. ADDITIONAL EQUIPMENT





Type	Name
EPSON	Receipt printer
	Printers supporting PCL6 (<i>Printer Command Language</i>) – connected via USB port
LS2208	Barcode scanner
SAL	Anti-vibration table for XA-series balance
	PC keyboard.

PC software:

„EDYTOR ETYKIET” [LABEL EDITOR] software

29. APPENDIX B – Programmable Buttons List

Pictogram	Function	Pictogram	Function
	Profile		Parameters
	Adjustment		Produkt change
	Zero		Warehouse change
	Tare		Customer change
	Set tare		Help
	Disable tare		Edit universal variable 1
	Enable tare		Edit universal variable 2
	Packaging		Edit universal variable 3
	Print		Edit universal variable 4
	Header printout		Edit universal variable 5
	Footer printout		Working mode change
	Units		Operator change
	Statistics		Abort
	Adding the measurement to statistics		Accept
	Disable last digit display		Disable three last digits display
	Disable two last digits display		Robot control

	Reference weights		Test weight
	Comparison procedure		Weights positioning wizard
	Quick comparison		



RADWAG WAGI ELEKTRONICZNE
ZAAWANSOWANE TECHNOLOGIE WAGOWE

