

IM01.EX

Communication Module

USER MANUAL

ITKU-100-02-12-18-EN











 **RADWAG** BALANCES AND SCALES
ADVANCED WEIGHING TECHNOLOGIES

DECEMBER 2018

PRECAUTIONS

Prior installation, use or maintenance activities, carefully read this User Manual. Use the IM01.EX-* communication module only as intended. This user manual must be at a reach of the operator's hand in the course of device operation.

	Symbol marking sections that are extremely important for protection against explosion.
	The device must be applied in accordance with the intended use only.
	Prior installation and start, it is necessary to analyse whether the IM01.EX-* communication module complies with the usage requirements regarding particular hazardous area. The analysis must be carried out by a qualified personnel.
	In case of any sign of damage, it is necessary to disconnect the device from the mains immediately. The damaged component must be replaced or repaired by RADWAG service immediately.
	While installing the device, it is necessary to follow strictly this user manual requirements. Not adhering to the requirements results with loss of explosion safety.
	Intrinsically safe circuits of IM01.EX-* communication module can be connected only to instruments characterised with respective intrinsic safety parameters. Connection method must be accordant with this user manual requirements. Connecting other than intrinsically safe or certified device, results with loss of explosion safety of the complete set.
	The device must be connected to the grounding permanently.
	Technical condition of the communication module must be tested and inspected by a trained personnel, in accordance with this user manual, at least once every three months.

Contents

1. INTENDED USE	5
2. WARRANTY CONDITIONS	6
3. SAFETY REQUIREMENTS	6
3.1. Data Plate	7
3.2. ATEX Markings – Symbols Meaning	8
3.3. Information Stickers and Security Seals Arrangement.....	9
4. TECHNICAL CONDITION INSPECTION	9
5. MAINTENANCE ACTIVITIES	10
6. SERVICE AND REPAIR	10
7. UTILISATION	11
8. MECHANICAL DESIGN	11
8.1. Main Components	11
8.2. Overall Dimensions	12
8.3. Technical Specifications	12
8.4. Intrinsic Safety Circuit Specification - HX5.EX (RS485) Connector.....	13
8.4.1. Basic Parameters for Cooperation With PUE HX5.EX-* Indicator	13
8.4.2. Extended Parameters	13
8.5. Models	13
8.6. Connectors Arrangement	14
8.7. Pins Assignment	14
8.8. 4IN/4OUT	15
8.8.1. Technical Specifications	15
8.8.2. 4IN/4OUT Schematic Diagrams.....	16
8.9. 12IN/12OUT Module	16
8.9.1. Technical Specifications	16
8.9.2. 12IN/12OUT Schematic Diagrams.....	17
8.9.3. 12IN/12OUT Signals.....	17
8.10. AN Analog Outputs Module.....	18
8.10.1. AN Module Configuration	18
8.10.2. Technical Specifications	19
8.10.3. AN Module: Diagrams of Connection Cables.....	19
8.11. RS485 Module	20
8.12. PROFIBUS Module	20
9. INSTALLATION AND START-UP	21
9.1. Communication Module Settings	21
9.2. Grounding	21
9.3. Connecting IM01.EX-* to the Mains.....	22
9.4. Connecting Intrinsically Safe Circuits.....	22
10. CONNECTION CABLES LIST	23
11. STANDARDS LIST	25

1. INTENDED USE

IM01.EX-* communication module is an associated facility intended for operation outside hazardous area, it is equipped with intrinsically safe circuits which may be placed in zones endangered with explosion. Separated non-intrinsically safe circuits of the device interfaces, and a power supply circuit, can cooperate with non-intrinsically safe circuits of devices, voltage of which is $U_m = 250 \text{ V AC}$.

IM01.EX-* communication module can be connected with PUE HX5.EX-*, indicator operating in hazardous area via an intrinsically safe interface.

Such solution enables cooperation of PUE HX5.EX-* indicator with numerous accessories: barcode scanners, printers, external displays, control buttons, light signalling towers, buzzers, PLC controllers and other controlling/signalling devices, PCs operating outside hazardous areas.

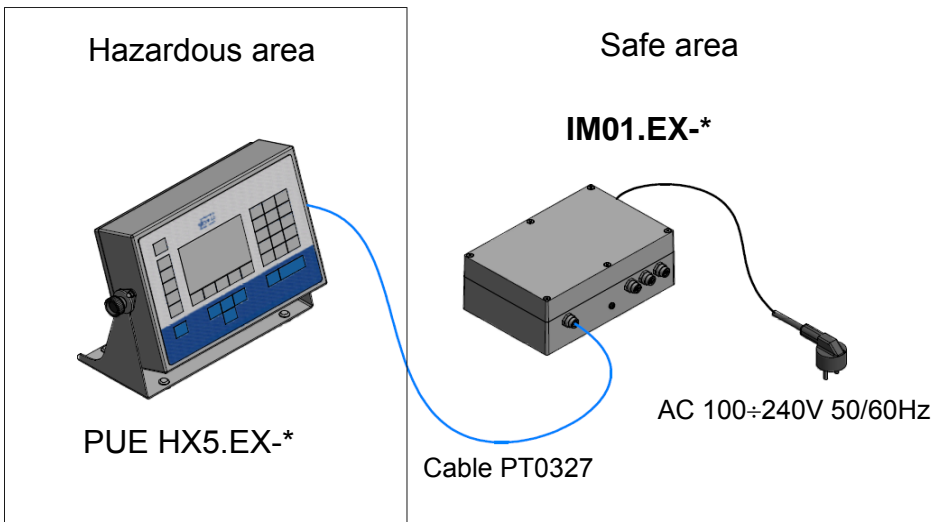

Figure 1. Installation of IM01.EX-* module

2. WARRANTY CONDITIONS

- A. RADWAG feels obliged to repair or exchange all elements that appear to be faulty by production or by construction.
- B. Defining defects of unclear origin and means of their elimination can only be realized with assistance of manufacturer and user representatives.
- C. RADWAG does not bear any responsibility for damage or losses resulting from unauthorized or inadequate performing of production or service processes.
- D. The warranty does not cover:
 - mechanical damage caused by product exploitation other than intended, damage of thermal and chemical origin, damage caused by lightning, overvoltage in the power network or other random event,
 - inappropriate cleaning habits.
- E. Loss of warranty takes place if:
 - a repair is carried out outside RADWAG authorized service point,
 - service claims intrusion into mechanical or electronic construction by unauthorized people,
 - the device does not have data plates or they are damaged.
- F. For detailed warranty conditions read the service card.
- G. Contact with the central authorized service: +48 (48) 386 63 30.

3. SAFETY REQUIREMENTS

Prior the first use, carefully read this user manual. Use the device only as intended.

IM01.EX-* communication module is intended for operation outside hazardous area (in safe area), it is equipped with intrinsically safe circuits which may be placed in:

- zone 1 and 2, where there is a risk of explosion due to mixture of air with vapour, mist or gas, classified as explosion group IIC, IIB and IIA,
- zone 21 and 22 where there is a risk of explosion due to mixture of air with dust, flammable fibres and volatile fuels, classified as explosion group IIIC, IIIB and IIIA.

Communication module marking:

for gases:  II [2]G [Ex ib Gb] IIC,

for dusts:  II [2]D [Ex ib Db] IIIC.

Explosion safety of IM01.EX-* communication module is ensured by:

- compliance with: EN 60079-0 and EN 60079-11 standards, approved by TEST 18 ATEX 0010X and IECEx OBAC 19.0002X certificates.
- the requirement that functional grounding cable which levels the potentials must always be connected to the marked terminal; disconnecting the functional grounding cable is forbidden; disconnecting potentials equalizing cable (e.g. when there is a need to place the device elsewhere) is allowed only after disconnection of power supply and intrinsically safe circuits,
- adhering to this user manual guidelines.

3.1. Data Plate

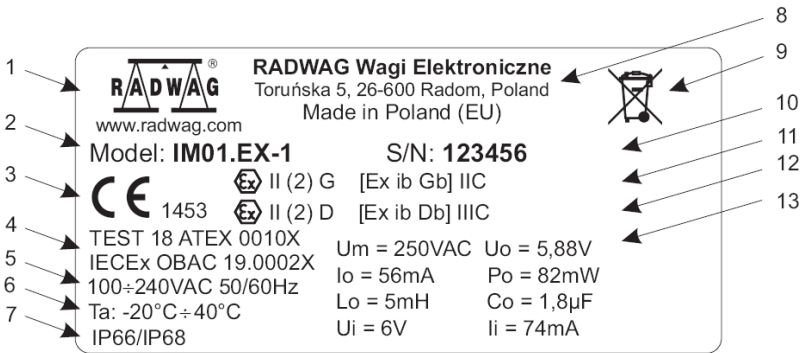

1	Manufacturer's logo.
2	Module symbol.
3	CE mark + notified body no.
4	Numbers of ATEX and IECEx certificates of the module with „X” symbol - special conditions of use.
5	Power supply.
6	Ambient temperature.
7	IP ingress protection.
8	Manufacturer's name and address.
9	WEEE symbol.
10	Serial number.
11	Ex mark: gases (read section 3.2).
12	Ex mark: dusts (read section 3.2).
13	Intrinsic safety parameters.

3.2. ATEX Markings – Symbols Meaning



II (2) G [Ex ib Gb] IIC

Equipment group:
I - to be used in mines where there's risk of mine gas explosion
II - to be used in places where there's risk of explosion of gases other than mine gases

Types of group II devices:
1 - equipment providing very high protection level,
 - for operation in zone 0,1,2
2 - equipment providing high protection level,
 - for operation in zone 1,2
3 - equipment providing standard protection level,
 - for operation in zone 2
() - symbol of an associated facility intended for operation outside hazardous area (in safe area), equipped with intrinsically safe circuits which may be placed in:
(1) – zones 0,1,2
(2) – zones 1,2
(3) – zone 2

Electrical equipment corresponding with one or several anti-explosion mechanical designs
[] – associated facility marking

Symbol of used explosion proof mechanical design:
mb - hermetic, for operation in zone 1,2,
tb – protection via housing for operation in zones 1,2,
eb - increased safety
ia - intrinsically safe design for operation in zone 0,1,2,
ib - intrinsically safe design for operation in zone 1,2.

Protection class gas atmosphere:
 - **Ga**
 - **Gb**
 - **Gc**
 dust atmosphere:
 - **Da**
 - **Db**
 - **Dc**

Explosive atmosphere:
G - caused by mixture of air with vapour, mist or gas.
D - caused by mixture of air with dust.

Gas explosion group, examples:
 - **IIA**: propane (T1) benzene (T3) butane (T2) ethanol (T2)
 - **IIB**: ethylene (T2)
 - **IIC**: acetylene (T2) hydrogen (T1)
 or dust, examples:
 - **IIIA**: volatile fuels
 - **IIIB**: non-conductive dust
 - **IIIC**: conductive dust

3.3. Information Stickers and Security Seals Arrangement

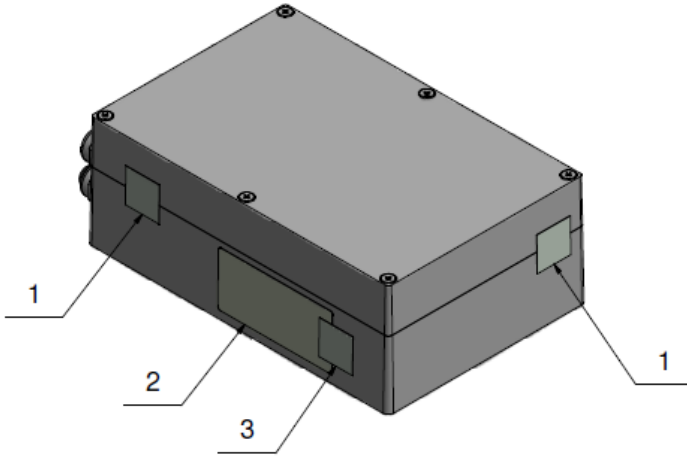

Figure 2. Arrangement of data plates and security seals (stickers)

- 1 - Cover's security seals.
- 2 - Data plate.
- 3 - Data plates' security seals (in case of data plates of void seal type, the security seals are not used).

4. TECHNICAL CONDITION INSPECTION



	<p><i>The technical condition of the IM01.EX-* communication module must be tested and inspected by a trained personnel (familiar with this user manual content) at least once every three months.</i></p>
--	---

In the course of inspection check:

- if there is no mechanical damage,
- functional grounding state:
 - cable-housing connection,
 - connection resistance – Max. 100 Ω ,
- cable glands - loose wires impermissible:
 - gland-housing torque – 4 Nm,
 - gland's cup nut torque – 2.5 Nm,
- hole plugs state – any unused connectors and ports must be covered.
- if the cover is tightly closed: cover screws torque – 0.5 Nm,
- data plates state - they must be complete and readable (not broken/damaged etc.).

5. MAINTENANCE ACTIVITIES

Prior maintenance it is necessary to disconnect the communication module from the mains, and to check grounding connection and state. You can clean the device using regular household cleaners.

	<p><i>To minimize the risk of electrostatic discharge, clean the housing using a wet cloth. It is especially important when the communication module is operated in a room where there is dry air. Moisture protects against accumulation of electrostatic charges.</i></p>
	<p><i>Avoid using abrasive cleaners while cleaning the communication module, do not use concentrated acids, bases, solvents or alcohol.</i></p>
	<p><i>It is not allowed to clean the communication module using compressed air.</i></p>

6. SERVICE AND REPAIR

	<p><i>In case of any sign of damage, it is necessary to disconnect the device from the mains immediately. The damaged component must be replaced or repaired by RADWAG service immediately.</i></p>
---	---

In case of any problems with correct operation of the module, contact the closest manufacturer's service point.

In case of defects, deliver the faulty product to the manufacturer's service point. If the product cannot be delivered to the manufacturer's service point, call the service and report the defect. Repair scope and method will be set up.

	<p><i>It is NOT ALLOWED to carry out any kind of repair of the device on one's own. Any attempt of module mechanical design modification, repair etc., by unauthorized persons, will result with loss of validity of manufacturer-issued certificates, declarations and warranty.</i></p>
---	--

7. UTILISATION

IM01.EX-* communication modules must be recycled, they are not to be treated as a regular household waste. Modules to be decommissioned must be decommissioned in accordance with valid legal regulations.



8. MECHANICAL DESIGN

8.1. Main Components

IM01.EX-* communication module consists of the following components:

1	Housing cover.
2	Housing base.
3	Intrinsically safe circuit connector.
4	Grounding terminal.
5	Cable glands and interfaces.
6	Fastening bolts.
7	Power cord.

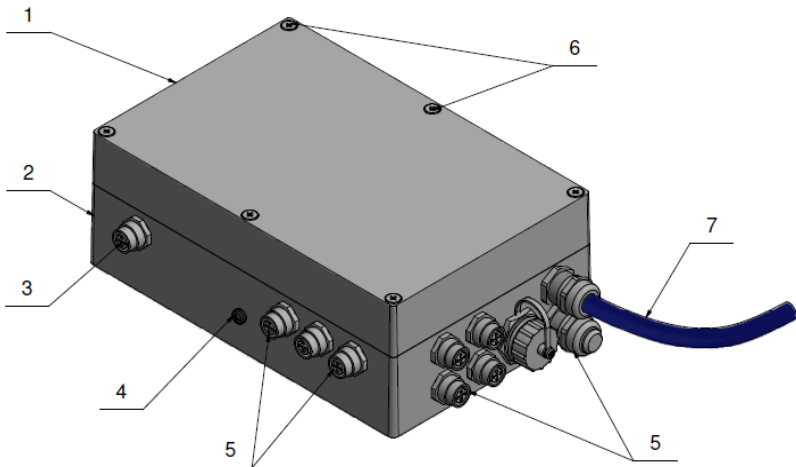

Figure 3. Module design, the main components

8.2. Overall Dimensions

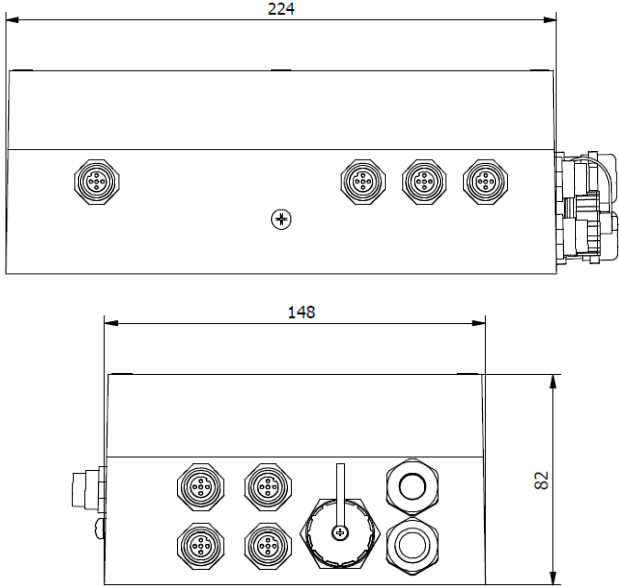

Figure 4. Overall module dimensions

8.3. Technical Specifications

	IM01.EX-*
Housing	aluminium, powder coated
IP ingress protection by EN 60529	IP66 / IP68
Power supply	100÷240 VAC 50/60 Hz
Ambient temperature	-20°C ÷ 40°C
Relative humidity	10÷85% RH, non-condensing conditions
Certificate	TEST 18 ATEX 0010X IECEx OBAC 19.0002X
Marking for gases	⊕Ex II (2)G [Ex ib Gb] IIC
Marking for dusts	⊕Ex II (2)D [Ex ib Db] IIIC
Intrinsically safe circuits intended for operation in zones	(gases) 1, 2 ; (dusts) 21, 22

8.4. Intrinsic Safety Circuit Specification - HX5.EX (RS485) Connector

8.4.1. Basic Parameters for Cooperation With PUE HX5.EX-* Indicator

Ui [V]	Ii [V]	Pi [mW]	Uo [V]	Io [mA]	Po [mW]	Lo[mH]	Co[μF]
6	74	specification not required	5.88	56	82	5	1.8

8.4.2. Extended Parameters

Ui [V]	Ii [V]	Pi [mW]	Uo [V]	Io [mA]	Po [mW]	Lo[mH]		Co[μF]	
						IIC	IIIC	IIC	IIIC
6	74	specification not required	5,88	56	82	19	50	0.88	8.3
						10	20	1.4	11
						5	10	1.8	12
						2	5	2.3	14
						1	2	2.7	17
						0.5	1	3.2	20
						0.2	0.5	4	24

8.5. Models

List of available models of communication module (* stands for version number):

1	standard (2xRS232, USB, Ethernet, 4IN/4OUT)
2	standard + analog outputs
3	12IN/12OUT
4	standard + PROFIBUS
5	PROFINET
6	standard + CANopen
7	standard + DeviceNet
8	standard + RS485
9	Ethernet IP

Design -2 and -3 may be combined with designs 4 - 9 and marked e.g.: IM01.EX-4/3.

8.6. Connectors Arrangement

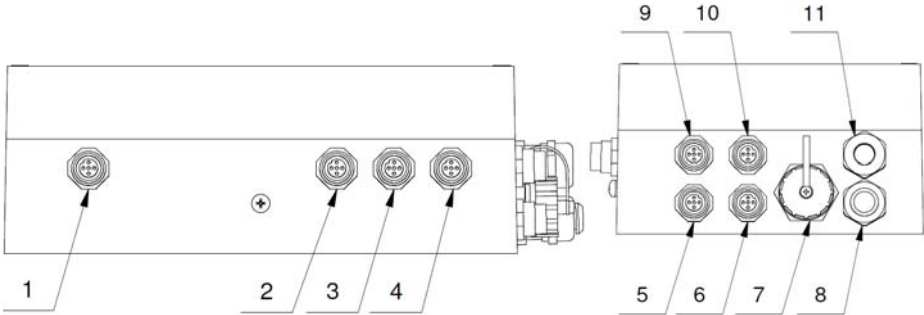
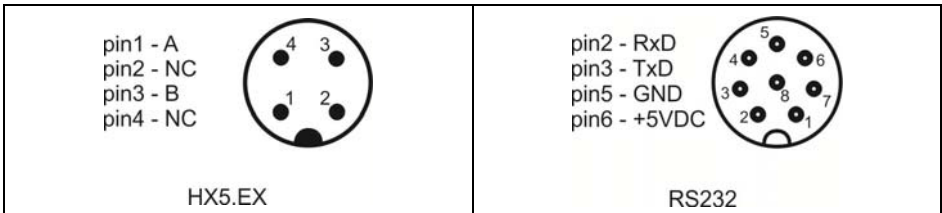
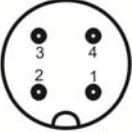
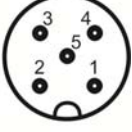



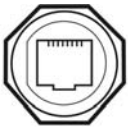

Figure 5. Connectors of IM01.EX-* communication module

1	<i>Intrinsically safe circuit connector (for PUE HX5.EX-* indicator).</i>
2	<i>RS232 (3) connector.</i>
3	<i>RS232 (4) connector.</i>
4	<i>USB connector.</i>
5	<i>40OUT connector (or cable gland 12OUT).</i>
6	<i>PROFIBUS OUT or DeviceNet connector.</i>
7	<i>Ethernet or PROFINET or Ethernet IP connector.</i>
8	<i>M16 cable gland - analog output.</i>
9	<i>4IN connector (or cable gland 12IN).</i>
10	<i>PROFIBUS IN or RS485 or CANopen connector.</i>
11	<i>Cable gland (power cord).</i>

8.7. Pins Assignment



<p>pin1 - VCC pin2 - D- pin3 - D+ pin4 - GND</p>  <p>USB</p>	<p>pin1 - PE pin2 - V+ pin3 - V- pin4 - CAN_H pin5 - CAN_L</p>  <p>CANOpen DeviceNet</p>
<p>pin1 - OUT1 pin2 - OUT2 pin3 - OUT3 pin4 - OUT4 pin5 - COMM pin6 - +VDC pin7 - GND</p>  <p>OUTPUTS</p>	<p>pin1 - IN1 pin2 - IN2 pin3 - IN3 pin4 - IN4 pin5 - COMM pin6 - +VDC pin7 - GND</p>  <p>INPUTS</p>
<p>pin1 - NC pin2 - A pin3 - NC pin4 - B pin5 - NC</p>  <p>PROFIBUS IN</p>	<p>pin1 - +5V pin2 - A pin3 - GND pin4 - B pin5 - NC</p>  <p>PROFIBUS OUT</p>
 <p>ETHERNET PROFINET ETHERNET IP</p>	

8.8. 4IN/4OUT

Signals are sent via M12 8P connectors.

8.8.1. Technical Specifications

Outputs parameters	
Outputs quantity	4
Outputs type	Solid-state relay
Maximum output current	0.5A DC
Maximum output voltage	30 VDC, AC

Inputs parameters	
Inputs quantity	4
Inputs type	Optoisolated
Input voltage range	5 - 24 VDC

8.8.2. 4IN/4OUT Schematic Diagrams

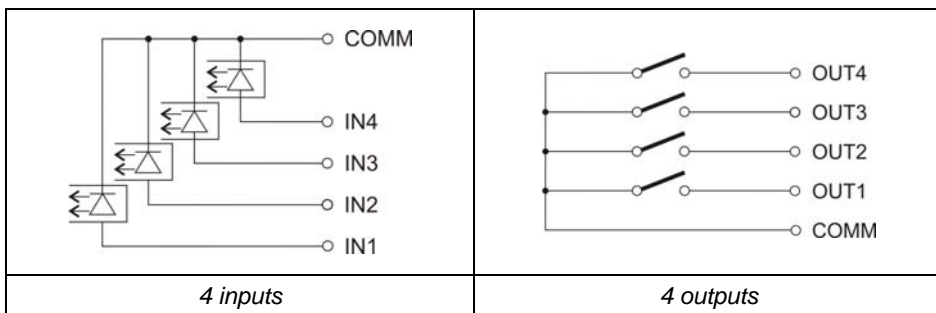

8.9. 12IN/12OUT Module

12IN/12OUT module features optoisolated inputs and solid-state relay outputs. The module allows free configuration of inputs and outputs (via menu of PUE HX5.EX-* indicator). Signals are sent via 3-meter long cables terminated with stripped wires, which cables are fed through cable glands.

8.9.1. Technical Specifications

Outputs parameters	
Outputs quantity	12
Outputs type	Solid-state relay
Cable cross-section	0.14 - 0.5 mm ²
Maximum output current	0.5 A DC
Maximum output voltage	30 VDC, AC
Inputs parameters	
Inputs quantity	12
Inputs type	Optoisolated
Cable cross-section	0.14 - 0.5 mm ²
Input voltage range	5 - 24 VDC

8.9.2. 12IN/12OUT Schematic Diagrams

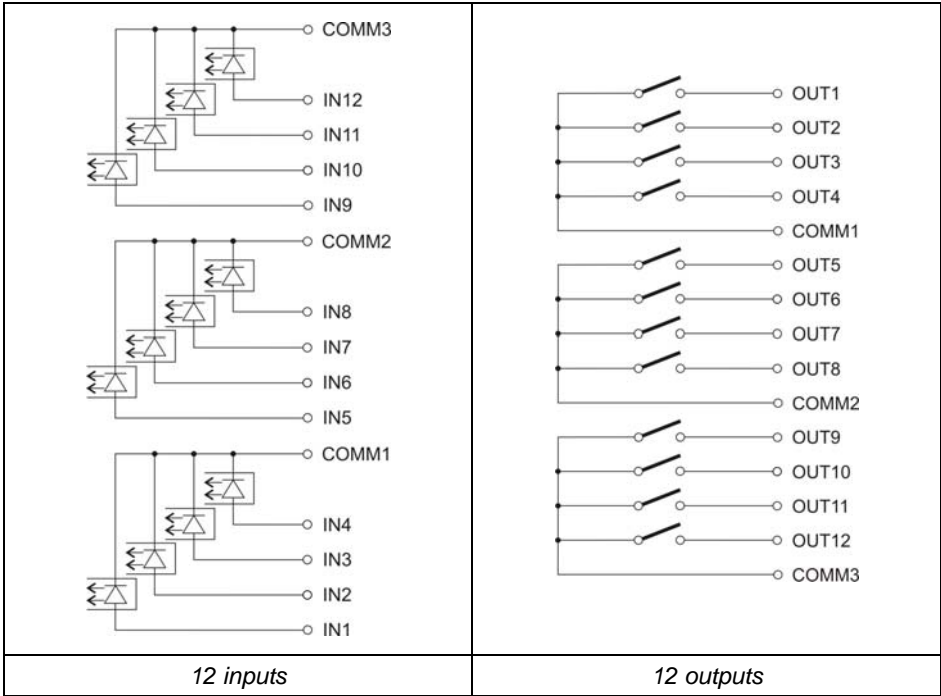

8.9.3. 12IN/12OUT Signals

Signals are sent via 16x0.5mm² cable with numbered wires.

INPUTS		OUTPUTS	
Wire no.	Signal	Wire no.	Signal
1	IN1	1	OUT1
2	IN2	2	OUT2
3	IN3	3	OUT3
4	IN4	4	OUT4
5	COMM1	5	COMM1
6	IN5	6	OUT5
7	IN6	7	OUT6
8	IN7	8	OUT7
9	IN8	9	OUT8
10	COMM2	10	COMM2

11	IN9	11	OUT9
12	IN10	12	OUT10
13	IN11	13	OUT11
14	IN12	14	OUT12
15	COMM3	15	COMM3

8.10. AN Analog Outputs Module

There are three AN module versions:

- Voltage output **AN 0-10V**.
- Current output **AN 4-20mA**.
- Current output **AN 0-20mA**.

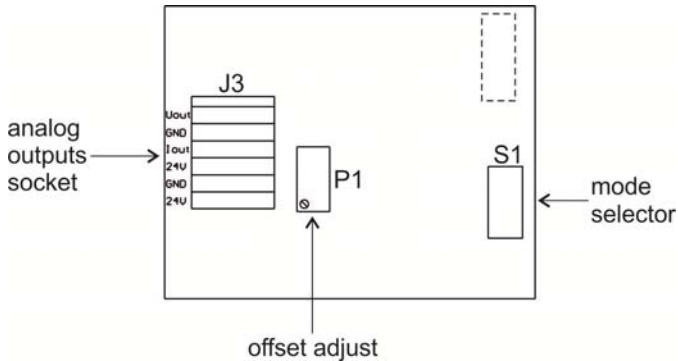

AN analog outputs module

8.10.1. AN Module Configuration

Operation mode is set using **S1** switch, follow the below description. On a board of analog outputs module, description of settings is to be found near **S1** switch.

R1	R2	OPERATION MODE
0	0	0-10V
0	1	4-20mA
1	0	0-20mA
1	1	0-24mA

BY DEFAULT ANALOG OUTPUTS MODULE MUST BE SET TO CURRENT OUTPUT 4-20mA MODE.

Analog output must be calibrated - set offset using P1 potentiometer (e.g. for 4-20mA output adjust P1 potentiometer so that for 0 kg indication the loop current is precisely 4 mA). In case of remaining operation modes proceed analogously.

8.10.2. Technical Specifications

Operation mode	4 - 20 mA , 0 - 20 mA, 0 - 10 V
Resolution	16 bit
Current output resistance	< 500 Ω
Voltage output resistance	> 400 Ω
Power supply	24 VDC (12 – 30 V DC), max 40 mA

8.10.3. AN Module: Diagrams of Connection Cables

Voltage output connection:

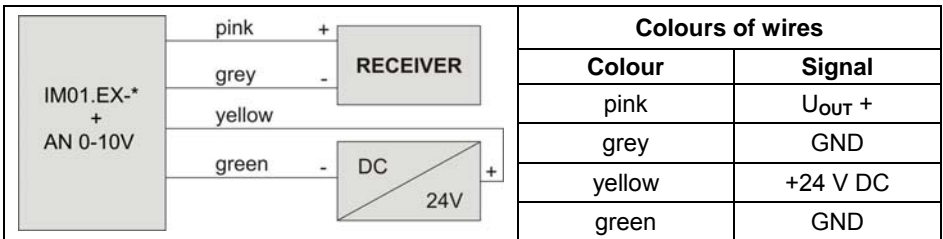

Current output connection:

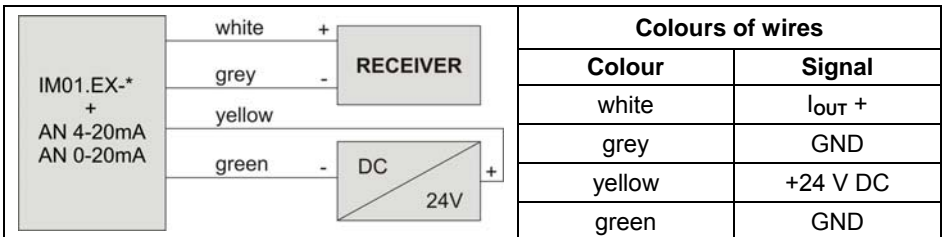

8.11. RS485 Module

IM01.EX-* module can be optionally equipped with RS485 interface. It is led via 3-meter long cable, fed through cable gland. For signals description refer to the below table.

A	Orange + green.
B	White-orange + white-green.

8.12. PROFIBUS Module

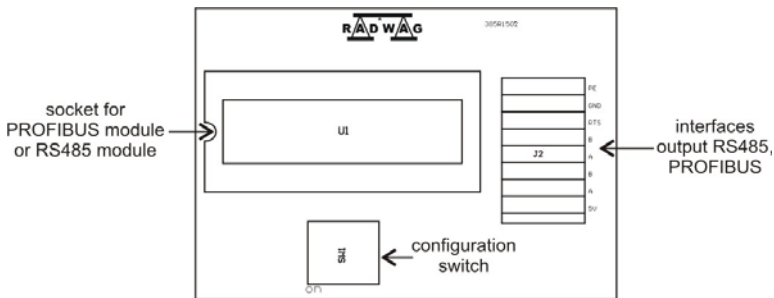

IM01.EX-* module can be optionally equipped with PROFIBUS interface. To enable this it is necessary to install **AB6000 Anybus-IC** module in U1 socket on the universal communication modules board (385Rxxxx board).



Position of PROFIBUS module on 385Rxxxx board

IM01.EX-* communication module is equipped with an input (male) and output (female) connector. On the output connector there is 5 VDC supply voltage that is crucial for correct operation of the indicator. Connectors of M12 5 pin with B coding standard are used (for PROFIBUS DP).

Pins assignment:

PROFIBUS IN (male)		Pin1 – NC Pin2 – A Pin3 – NC Pin4 – B Pin5 – NC
PROFIBUS OUT (female)		Pin1 – +5V Pin2 – A Pin3 – GND Pin4 – B Pin5 – NC

9. INSTALLATION AND START-UP

Prior installation and start-up, carefully read this user manual. Use the device only as intended.

RADWAG does not bear any responsibility for damage or losses resulting either from improperly carried out installation or misuse.

	<p><i>Prior installation and start, it is necessary to analyse whether the intrinsically safe circuits of the device comply with the usage requirements regarding particular hazardous area. The analysis must be carried out by a qualified personnel.</i></p>
---	--

	<p><i>Installation has to be carried out by an authorized personnel in accordance with regulations, standards and good engineering practice.</i></p>
---	---

9.1. Communication Module Settings

The communication module must be unpacked in safe area. At a workplace it must be placed on an even and stable ground, away from heat sources and processes in which electrostatic dischargers occur. The module must be protected against solar radiation.

	<p><i>When transporting the communication module to a different workstation, it is necessary to follow all safety precautions.</i></p>
---	---

9.2. Grounding

- Prepare the functional grounding cable.
- Install the communication module at the workstation.
- Connect the functional grounding cable to the equipotential bonding and to the communication module.
 - The functional grounding cable must be terminated with ring, of min. 4.2mm diameter, enabling you to couple the cable to the grounding terminal.
 - Use lock washer in order to keep the ring pressed tightly against the housing.
 - Use grounding cable of 4 mm² cross-section with yellow-green shield.

- Connect the communication module and the device it powers to the same equipotential bonding.



Spots marked with „ \perp ” symbol are intended for the functional grounding cable.



Connect the communication module and the grounding when there is no risk of explosive atmosphere occurrence.

9.3. Connecting IM01.EX-* to the Mains

IM01.EX-* communication module is equipped with cable terminated with a plug featuring a ground pin, plug type is conditioned by region/country. Connect the cable to the wall outlet with a ground pin.



It is not allowed to connect the IM01.EX-* communication module's plug to the wall outlet located in the hazardous area.

9.4. Connecting Intrinsically Safe Circuits.

IM01.EX-* communication module is equipped with a connector for intrinsically safe circuit, marked as HX5.EX, used to connect PUE HX5.EX-* indicator.

Connect the PUE HX5.EX-* indicator to an IM01.EX-* communication module via a dedicated cable, **PT0327**.



Connect the communication module to devices operating in hazardous area when there is no risk of explosive atmosphere occurrence.

10. CONNECTION CABLES LIST

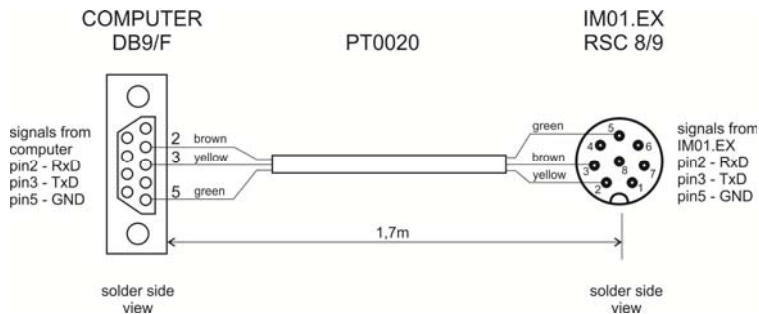

IM01.EX- module – computer cable*

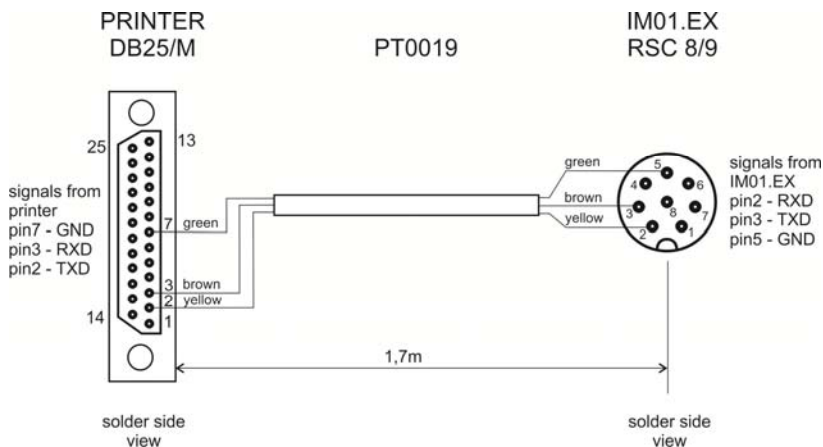

IM01.EX- module – printer cable (EPSON)*

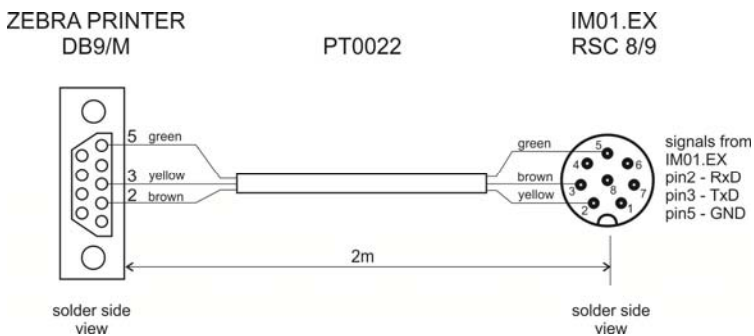

IM01.EX- module – printer cable (ZEBRA)*

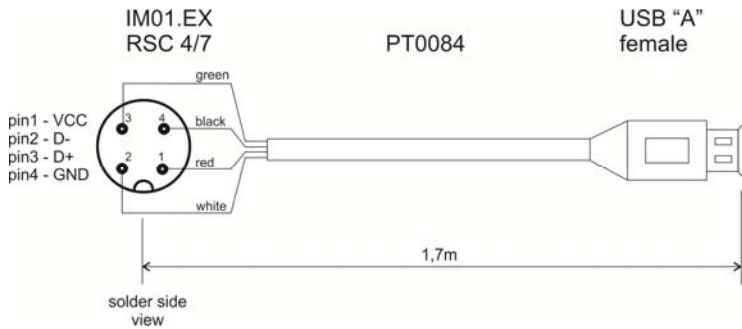

IM01.EX- module - USB adapter cable*

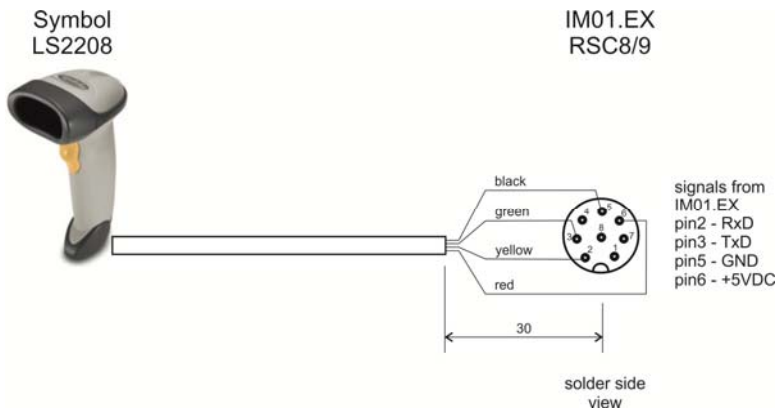

IM01.EX- module – barcode scanner cable (LS2208)*

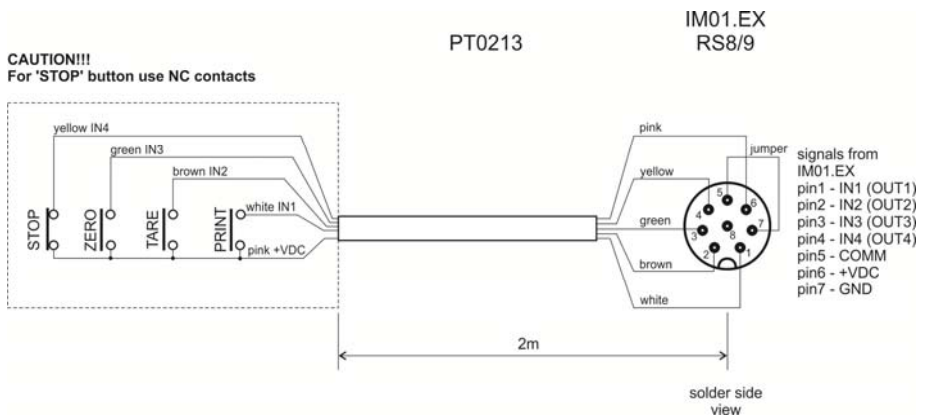

IM01.EX- module – PRINT, TARE, ZERO, STOP cable*

PT0256 IM01.EX
RSTS 8-184/2M

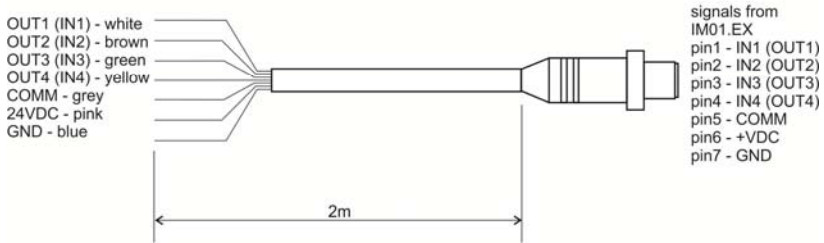

IM01.EX-*/module - IN/OUT cable



„Scale-Ethernet” cable is a standard network cable terminated with RJ45 connectors on both ends.

11. STANDARDS LIST

The device is manufactured in accordance with the following standards:

1. EN 61326-1:2013-06 *Electrical equipment for measurement, control and laboratory use - EMC requirements - Part 1: General requirements.*
2. EN 61010-1:2011 *Safety requirements for electrical equipment for measurement, control and laboratory use - Part 1: General requirements.*
3. EN 60079-0:2013-03 + A11:2014-03 *Explosive atmospheres - Part 0: Equipment - General requirements.*
4. EN 60079-11:2012 *Explosive atmospheres - Part 11: Equipment protection by intrinsic safety "i".*
5. EN 60529:2003 *Degrees of protection provided by enclosures (IP Code).*



RADWAG BALANCES AND SCALES
ADVANCED WEIGHING TECHNOLOGIES

