

5Y Mass Comparators

APP 30.5Y.KO Mass Comparator

***APP 30.5Y.KO* Mass Comparator - with self-centring weighing pan**

APP 64.5Y.KO Mass Comparator

***APP 64.5Y.KO* Mass Comparator - with self-centring weighing pan**

USER MANUAL

IMKO-05-07-04-23-EN



If you are reading this, it means that you are bound to achieve success.
You have purchased a device that was designed and manufactured to give you years of service.
Congratulations and thank you for selecting RADWAG product.

APRIL 2023

CONTENTS

| | |
|--|-----------|
| 1. GENERAL INFORMATION | 6 |
| 1.1. Intended Use | 6 |
| 1.2. Precautions | 6 |
| 1.3. Warranty Conditions | 6 |
| 1.4. Supervision over Metrological Parameters | 6 |
| 1.5. User Manual Significance | 7 |
| 1.6. Operator Training | 7 |
| 2. TRANSPORT AND STORAGE | 7 |
| 2.1. Delivery Checklist | 7 |
| 2.2. Packaging | 7 |
| 3. UNPACKING AND INSTALLATION | 7 |
| 3.1. Workstation | 7 |
| 3.2. Standard Delivery Component List | 7 |
| 3.3. Connectors | 8 |
| 3.4. Unpacking | 8 |
| 3.5. Maintenance Activities | 10 |
| 3.6. Connecting the Weighing Instrument to the Mains | 11 |
| 3.7. Temperature Stabilization Time | 12 |
| 3.8. Connecting Additional Hardware | 12 |
| 4. START-UP | 12 |
| 5. PROGRAM | 13 |
| 6. WEIGHING RESULT WINDOW | 13 |
| 7. LOG IN OPERATION | 14 |
| 8. OPERATING THE MENU | 15 |
| 8.1. Buttons | 15 |
| 8.2. Voice Commands | 15 |
| 8.3. Return to the Comparison Mode | 17 |
| 9. COMPARISON | 17 |
| 9.1. Selecting Comparison Unit | 17 |
| 9.2. Correct Comparison Principles | 17 |
| 9.3. Mass Comparator Levelling | 18 |
| 9.4. Zeroing | 18 |
| 9.5. Taring | 18 |
| 9.6. Running Working Mode | 19 |
| 9.7. Working Mode Parameters – Comparator | 20 |
| 9.8. Quick Access Keys, Proximity Sensors | 20 |
| 9.8.1. Proximity Sensors | 22 |
| 9.9. Working Mode – Comparator | 22 |
| 9.10. Selecting Measuring Method in Mass Comparator | 23 |
| 9.11. Determining Cycle Quantity | 24 |
| 9.12. Determining Quantity of Start-up Weighing Cycles | 24 |
| 9.13. Start Delay | 24 |
| 9.14. Tare Mode | 24 |
| 9.15. Printout/Enter Mode | 24 |

| | |
|--|-----------|
| 9.16. Printouts | 25 |
| 9.17. Completed Comparison Processes Report | 27 |
| 9.18. Managing the Display Information and Shortcut Keys | 28 |
| 9.19. Mass Comparison Process - Basic Procedure | 29 |
| 10. ADJUSTMENT | 30 |
| 10.1. Internal Adjustment | 30 |
| 10.2. External Adjustment | 30 |
| 10.3. User Adjustment | 30 |
| 10.4. Adjustment Test..... | 30 |
| 10.5. Automatic Adjustment | 31 |
| 10.6. Automatic Adjustment Time..... | 31 |
| 10.7. Report Printout | 31 |
| 10.8. GLP Project..... | 31 |
| 10.9. Adjustment History..... | 32 |
| 11. ADMINISTRATOR PANEL..... | 32 |
| 11.1. Password Setting..... | 32 |
| 11.2. User Account Setting | 33 |
| 11.3. Permissions Management | 34 |
| 12. PROFILES..... | 35 |
| 12.1. Profile Structure | 36 |
| 12.1.1. Settings | 36 |
| 12.1.2. Working Modes | 36 |
| 12.1.3. Readout | 36 |
| 12.1.4. Measuring Units | 38 |
| 13. DATABASES..... | 39 |
| 13.1. Processes Carried Out on Databases | 39 |
| 13.2. Operators..... | 40 |
| 13.3. Products..... | 45 |
| 13.4. Customers..... | 46 |
| 13.5. Reference Weights..... | 46 |
| 13.6. Test Weights..... | 46 |
| 13.7. Comparison Procedures..... | 47 |
| 13.8. Packaging..... | 47 |
| 13.9. Warehouses..... | 48 |
| 13.10. Printouts | 48 |
| 13.11. Universal Variables..... | 50 |
| 13.12. Database Management | 50 |
| 13.12.1. Delete Databases | 50 |
| 14. REPORTS..... | 51 |
| 14.1. Reports Operations..... | 51 |
| 14.2. Weighings | 52 |
| 14.3. Comparison Reports | 53 |
| 14.4. Weight adjustment reports | 53 |
| 14.5. Ambient Conditions | 53 |
| 14.6. Databases Management | 54 |
| 14.6.1. Export Weighing Database to a File | 54 |
| 14.6.2. Delete Weighings and Reports..... | 55 |
| 15. COMMUNICATION | 57 |

| | |
|---|-----------|
| 15.1. RS 232 Settings | 57 |
| 15.2. ETHERNET Settings | 57 |
| 15.3. Wi-Fi Settings | 58 |
| 16.3.1. Hot Spot | 59 |
| 16.3.2. Switching Hot Spot Service On | 59 |
| 15.4. TCP Settings | 61 |
| 17. PERIPHERALS | 62 |
| 17.1. Computer | 62 |
| 17.2. Printer | 63 |
| 17.3. Barcode Scanner..... | 66 |
| 17.4. Port | 66 |
| 17.5. Prefix/Suffix | 66 |
| 17.6. Field Selection | 66 |
| 17.7. Test..... | 67 |
| 17.8. Ambient Conditions Module | 68 |
| 18. MISCELLANEOUS..... | 68 |
| 18.1. Language..... | 68 |
| 18.2. Date and Time..... | 68 |
| 18.3. Extension Module..... | 70 |
| 18.4. Sound | 70 |
| 18.5. Display Sleep Mode | 70 |
| 18.6. Display Brightness | 70 |
| 18.7. Vibration Detection | 70 |
| 18.8. Level Control..... | 71 |
| 18.9. Decimal Point | 71 |
| 18,10, Proximity Sensors Sensitivity..... | 71 |
| 18.11. Doorway Degree | 72 |
| 18.12. Automatic Ionisation | 72 |
| 18.13. Autotest..... | 72 |
| 18.14. Start-Up Logo..... | 75 |
| 18.15. Export of System Events..... | 75 |
| 18.16. Text-to-Speech Conversion | 75 |
| 19. SCHEDULED TASKS | 76 |
| 19.1. Adjustment | 76 |
| 19.2. Message | 77 |
| 20. AMBIENT CONDITIONS | 79 |
| 21. UPDATE..... | 80 |
| 22. ABOUT | 80 |
| 23. COMMUNICATION PROTOCOL | 81 |
| 23.1. Manual Printout/Automatic Printout..... | 81 |
| 24. PERIPHERAL DEVICES..... | 81 |
| 25. ERROR MESSAGES..... | 82 |
| 26. ADDITIONAL EQUIPMENT | 83 |
| 27. APPENDIX B – Programmable Buttons List | 83 |

1. GENERAL INFORMATION

1.1. Intended Use

5Y mass comparators enable determining difference between mass of a test weight (B) and known reference weight (A) during calibration process.

Mass comparators are widely applied in laboratories and in national metrological institutes for mass standards and weights calibration.

1.2. Precautions

- Prior to the first use, carefully read this User Manual. Use the comparator only as intended.
- Do not operate the touch panel using sharp-edged tools (knife, screwdriver, etc.).
- While loading the balance make sure that loads are placed in the very centre of the weighing pan.
- Load the weighing pan with loads gross weight of which does not exceed instrument's measuring range (maximum capacity).
- In the case of defect, immediately unplug the instrument from the mains.
- Mass comparator to be decommissioned, should be decommissioned in accordance with valid legal regulations.
- Not intended for usage within hazardous areas. Mass comparator is not designed to operate in EX zones.

1.3. Warranty Conditions

- A. RADWAG feels obliged to repair or exchange all elements that appear to be faulty by production or by construction,
- B. Defining defects of unclear origin and means of their elimination can only be realized with assistance of manufacturer and user representatives,
- C. RADWAG does not bear any responsibility for defects or losses resulting from unauthorized or inadequate performing of production or service processes,
- D. Warranty does not cover:
 - mechanical defects caused by product exploitation other than intended, defects of thermal and chemical origin, defects caused by lightning, overvoltage in the power network or other random event,
 - mechanical defects caused by mass comparator exploitation other than intended,
 - mass comparator defects, if service claims removing or destroying protective stickers which secure its housing against unauthorized access,
 - mechanical defects or defects caused by liquids and natural wear,
 - mass comparator defects caused by inappropriate setting or by electrical wiring failures,
 - defects caused by overloading the mechanical measuring system,
 - maintenance activities (mass comparator cleaning).
- E. Loss of warranty takes place if:
 - a repair is carried out outside RADWAG sales office or authorized service point,
 - service claims intrusion into mechanical or electronic construction by unauthorized people,
 - other version of the operating system is installed in a mass comparator,
 - mass comparator does not bear protective sealing.
- F. Detailed warranty conditions are listed on a service card.

1.4. Supervision over Metrological Parameters

Metrological parameters of mass comparator need to be checked in determined time intervals. Inspection frequency depends on ambient conditions in which the mass comparator is used, types of performed processes and accepted quality management system in organization.

1.5. User Manual Significance

It is very important to read the user manual carefully before switching on and starting up mass comparator operation, even if you are experienced and have worked with this type of comparator before. This user manual contains crucial information for correct operation of the mass comparator; following the guidelines guarantees trouble-free operation of the comparator.

1.6. Operator Training

Mass comparator has to be utilized and supervised only by operators who are trained and experienced in using such type of weighing instruments.

2. TRANSPORT AND STORAGE

2.1. Delivery Checklist

Upon delivery it is necessary to check the package and the device, make sure that your package bears no signs of damage. If it does, contact the manufacturer's representative.

2.2. Packaging

Keep all package elements should your device be transported in the future. Remember that only original packaging can be used for shipping purposes. Prior packing, uncouple any cables, remove any separable components (weighing pan, shields, inserts). The mass comparator components shall be packed into an original packaging, thus being protected against potential damage during transportation.

Caution:

While preparing the mass comparator to be packed, disassemble the comparator in reverse order to the comparator installation presented in section 3. Make sure the mechanism interlocks are reassembled to prevent damage of the comparator.

3. UNPACKING AND INSTALLATION

3.1. Workstation

- Mass comparator has to be stored and used in locations free of vibrations and shakes, free of air movement and dust.
- Ambient air temperature cannot exceed the range of: $+15\text{ °C} \div +30\text{ °C}$ and its change cannot exceed $0.5\text{ °C}/12\text{h}$.
- Relative humidity range: $40\% \div 60\%$ and its change cannot exceed $2\%/4\text{h}$.
- Mass comparator has to be located on a stable wall console desk or a stable working table which is not affected by vibrations and distant from heat sources.
- Take special precaution when calibrating magnetic weights, as part of the comparator is a strong magnet. Weights magnetic cannot exceed the values presented in the table below:

3.2. Standard Delivery Component List

- Mass comparator
- Weighing pan
- Indicator
- Anti-draft chamber
- Power supply

3.3. Connectors

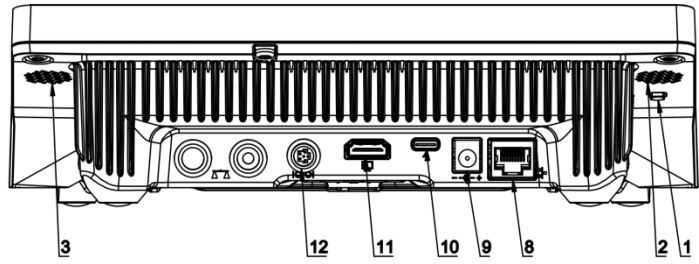
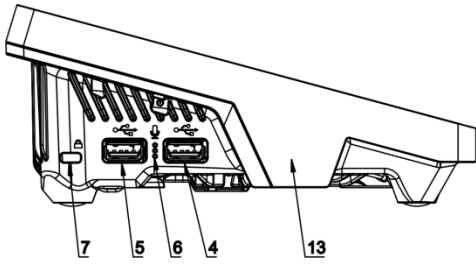

Top view

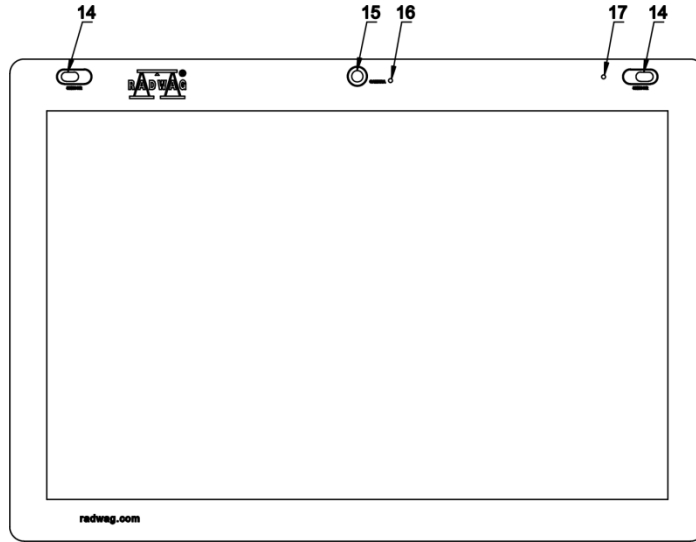

| | | | |
|----------|------------------|-----------|---------------------------|
| 1 | Restart, on/off. | 10 | Power socket – USB type C |
| 2 | Left speaker | 11 | HDMI port |
| 3 | Right speaker | 12 | Media box port |
| 4 | USB type A | 13 | RFID sensor |
| 5 | USB type A | 14 | Proximity sensors |
| 6 | Microphone | 15 | Camera |
| 7 | Kensington Lock | 16 | Camera diode |
| 8 | Ethernet port | 17 | Signalling diode |
| 9 | Power socket | | |

3.4. Unpacking

Cut the adhesive tape. Take the device out of the packaging. Open the accessory box, take the device components out of it.

Prior mass comparator installation, read this user manual in order to correctly prepare the device for operation.

Caution:

Be careful so as not to cause damage to the mechanism.

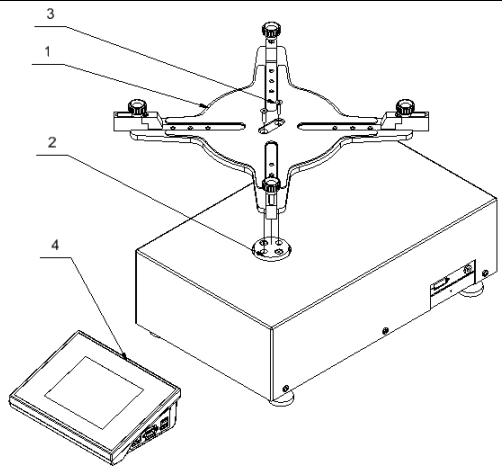
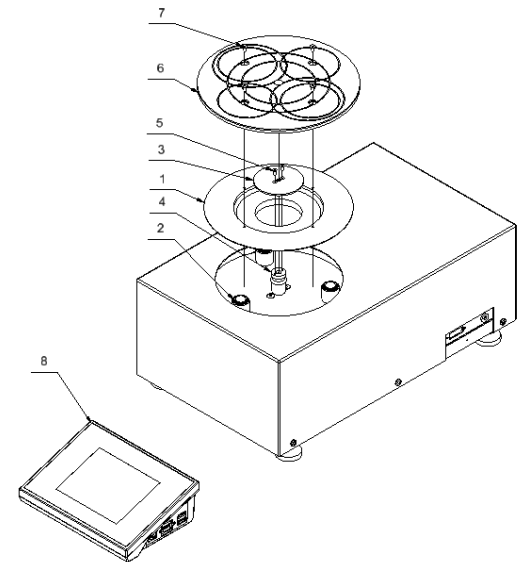
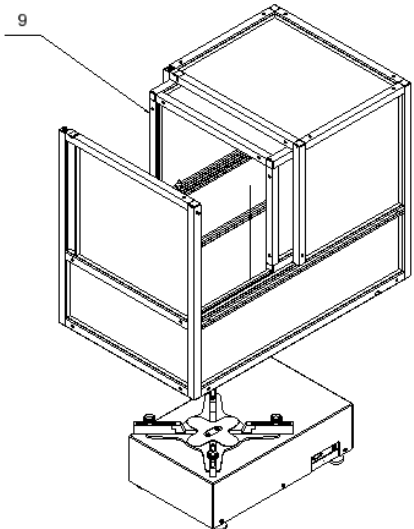
| Mass comparator installation | | APP 30.5Y.KO | APP 64.5Y.KO | *APP 30.5Y.KO* | *APP 64.5Y.KO* |
|--|--|--------------|--------------|----------------|----------------|
| 1. Tighten the weighing pan assembly (1) to the spacer (using 2 M5 screws (3) |  | ◀ | ◀ | | |
| 2. Connect the indicator (4) to the mass comparator | | ◀ | ◀ | | |
| 3. Connect the indicator to the mains | | ◀ | ◀ | | |
| 1*. Install the guide plate (1) to the mandrels (. Tighten the lock (3) to the bumper (4) using M3 screws (5) and tighten the weighing pan (6) to the guide plate (1) using M4 screws (7). |  | | | ◀ | ◀ |
| 2*. Connect the indicator (8) to the mass comparator | | | | ◀ | ◀ |
| 3*. Connect the power supply. | | | | ◀ | ◀ |
| 4. Install anti-draft chamber (9) |  | ◀ | ◀ | ◀ | ◀ |

APP 30.5Y.KO - version with self-centring weighing pan

APP 64.5Y.KO - version with self-centring weighing pan

3.5. Maintenance Activities

Caution:

Cleaning weighing pan while still installed may cause damage of the measuring system.

1. Disassembly a weighing pan and other detachable components. Be careful so as not to damage the mechanism.
2. Using handheld vacuum cleaner remove dust from the weighing chamber.

Cleaning anti-draft chamber panes:

Select dissolvent depending on a dirt. Never soak the glass panes in alkaline solutions since they interact with glass and may cause damage. Do not use abrasive substances.

For organic dirt use acetone first, next use water or detergent. For other than organic dirt use diluted acid solutions (soluble salts of hydrochloric or nitric acid) or base solutions (ammonium or sodium base).

To remove ACIDS use protofilic solvent (sodium carbonate), to remove BASE use protogenic solvent (mineral acid of various concentration).

In the case of heavy contamination use brush or detergent. nevertheless avoid detergents containing large and hard molecules which could potentially scratch glass panes.

At the end of the cleaning process rinse the pane using distilled water.

Use soft brush with wooden or plastic handle exclusively to avoid risk of scratches. Do not use wire brush.

Rinsing is a necessary cleaning process stage allowing you to remove remaining soap, detergents and other cleansers from the panes prior to their reinstallation.

At the end of the cleaning process rinse the pane using running water first, distilled next.

Avoid drying the panes either using paper towel or forced air circulation since some fibres, grains or contamination of other type could permeate into the panes thus causing weighing errors.

One shall not use driers when drying measuring glass tools.

It is a frequent treatment to leave glass components on a rack to dry.

Cleaning powder-coated components:

For preliminary cleaning stage you need running water or wet sponge featuring large holes, this will help you to remove loose, heavy dirt.

Do not use cleansers containing abrasive substances.

Next using cloth and cleanser-water solution (soap, dishwashing liquid) gently rub the cleaned surface.

Avoid using cleanser without water since it may result with damage of the cleaned surface, please mind that large amount of water mixed with cleanser is a must.

Cleaning aluminium components:

While cleaning aluminium components use products acid by nature, e.g. spirit vinegar, lemon. Do not use abrasive substances. Avoid using hard brush, this may cause scratches. It is recommended to use microfiber cloth.

While polishing the surface use circular movements. Use clean, dry cloth to dry the surface and to polish it.

Cleaning stainless steel components:

While cleaning stainless steel components refer to the below table.

| | |
|-------------------------------------|---|
| <i>Fingerprints</i> | <i>Clean using spirit or thinner. Rinse with clear water, and dry using cloth.</i> |
| <i>Oil, fat, grease</i> | <i>Clean using organic solvents first, warm water with either soap or mild detergent next. Rinse with clear water, and dry using cloth.</i> |
| <i>Spots and temperatura stains</i> | <i>Clean using mild scouring detergent, mind to make gentle movements following direction marked by the surface structure. Rinse with clear water and dry using cloth.</i> |
| <i>Heavy discoloration</i> | <i>Clean making gentle movements following direction marked by the surface structure. Rinse with clear water, and dry using cloth.</i> |
| <i>Rust</i> | <i>Moisten with oxalic acid solution and leave for about 15-20 minutes, next wash with warm water containing addition of either soap or mild detergent. Rinse with clear water, and dry using cloth.</i> |
| <i>Paints</i> | <i>Clean using paint solvent, next wash with warm water containing addition of either soap or mild detergent. Rinse with clear water, and dry using cloth.</i> |
| <i>Scraches</i> | <i>Polish using cloth free-of-iron, mind to make gentle movements following direction marked by the surface structure, next clean using mild scouring detergent. Rinse with clear water, and dry using cloth.</i> |

Cleaning ABS Components:

To clean dry surfaces and avoid smudging, use clean non-colouring cloths made of cellulose or cotton. You can use a solution of water and detergent (soap, dishwashing detergent, glass cleaner). Gently rub the cleaned surface and let it dry. Repeat cleaning process if needed.

In the case of hard to remove contamination, e.g.: residues of adhesive, rubber, resin, polyurethane foam etc., you can use a special cleaning agents based on a mixture of aliphatic hydrocarbons that do not dissolve plastics. Before using the cleanser for all surfaces we recommend carrying out tests. Do not use cleansers containing abrasive substances.

3.6. Connecting the Weighing Instrument to the Mains

The mass comparator can be connected to the mains only with a power supply that comes standard with a particular model. Nominal voltage of the power supply (specified on the power supply data plate) has to be compatible with the power from the mains.

Plug the mass comparator to the mains, i.e. connect the power supply to the socket first, next connect its connector to a port located at the back of the comparator housing.

3.7. Temperature Stabilization Time

Before start of the measuring processes, it is necessary to wait until the mass comparator reaches thermal stabilisation.

For mass comparators that were stored in much lower temperatures than the workroom temperature, before being plugged to the mains must be subjected to thermal stabilisation that shall take at least 12 hours. During the thermal stabilization, the indications on the screen can change. Potential workroom temperature change shall occur gradually and slowly in the course of the weighing instrument operation.

3.8. Connecting Additional Hardware

Use only accessories and peripheral equipment recommended by the manufacturer. The mass comparator must be disconnected from the mains before connecting or disconnecting any peripherals (printer, PC computer, computer keyboard). Upon connecting the peripherals, plug the comparator to the mains.

4. START-UP

- Connect the mass comparator to the mains

CAUTION: There are two power sockets: indicator – power socket 1, weighing mechanism housing – power socket 2. The weighing device can be powered either via power socket 1 or via power socket 2 but it is not allowed to power the instrument using two power supplies plugged into both power sockets at once.

- Operating system and RADWAG software start loading. During the program start-up, signalling diode and LED diode (located at the lower front part of the indicator) blink.
- Upon completed start-up, the home screen is displayed automatically.
- The mass comparator runs with no operator logged in. In order to start operation it is necessary to carry out the logging procedure (for detailed logging procedure read later sections of this user manual).

Should the software freeze during operation, the device needs rebooting. To reboot the device press and hold the reboot button for about 5 sec. Device restart proceeds.

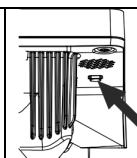

5. PROGRAM

Program menu is divided into function groups. Function group is a group of interrelated parameters. For detailed description of each function group read later sections of this user manual.

Function Groups:

Mass comparator's main menu is accessed by pressing  button, located in the bottom part of the display. The menu comprises parameters referring to mass comparator settings, functions and profiles.

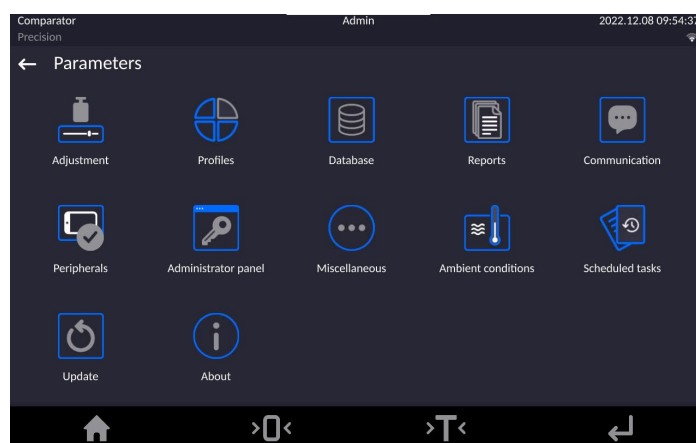

6. WEIGHING RESULT WINDOW

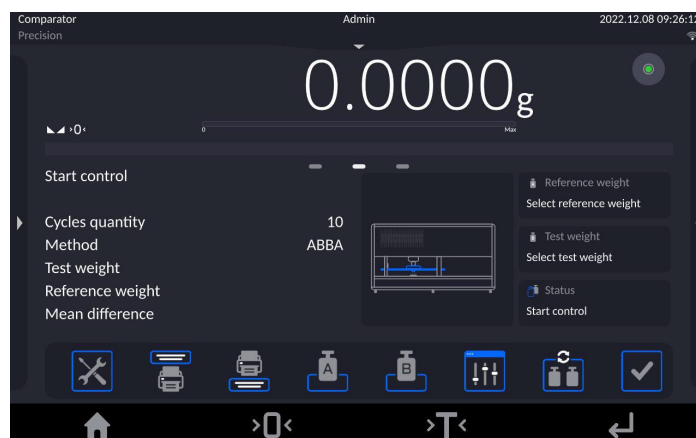

The home screen features 5 sections:

- Top section displaying data on active working mode, logged operator, date, time, active connection to a computer.

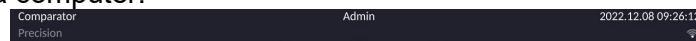

- Section presenting the weighing result and current level status.

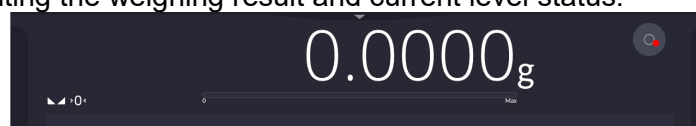

- Section containing additional data on currently carried out activities.



Caution:

The data is freely configurable. For detailed instruction read later sections.

- Section with a set of on-screen function buttons:

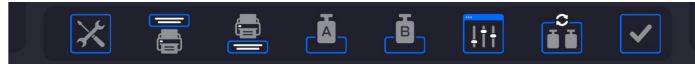

Caution:

You can define the on-screen function buttons. For detailed instruction read later sections.

- Section with a set of fixed function buttons:



7. LOG IN OPERATION

In order to access operator-related parameters and edit databases, you need to log in as an operator with **<Administrator>** permission level.

To do this, pull down the menu at the top of the display.

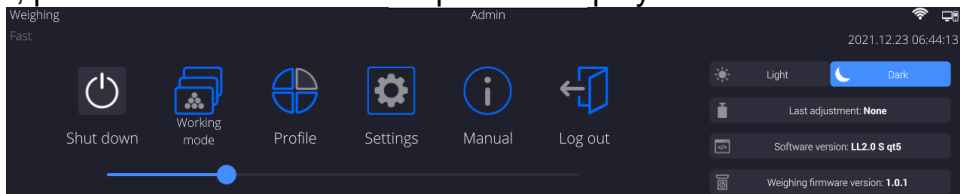

First Log in:

- Pull down the top menu, press **<Log in>** field, operators database window is opened featuring **<Admin>** entry.

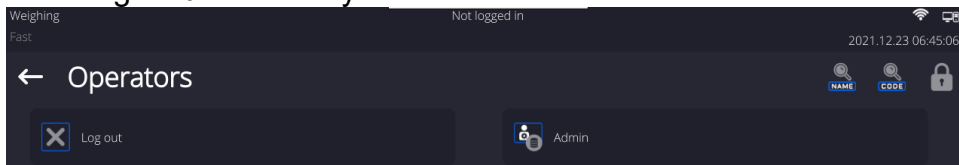

- The home screen is displayed, **<Not logged in>** sign is replaced by **<Admin>** sign.

CAUTION: After first logging in, enter operators and assign appropriate permission levels and individual access passwords to them (for detailed procedure, read sections 10 and 28.2). While logging in again, select an operator from the list and enter the password, the program initiates operation with permission level set for the selected operator.

Log out operation:

- Pull down the menu at the top of the display.
- Press **<Log out>** field.

The home screen is displayed, logged in operator name is replaced with **<Not logged in>** entry.

8. OPERATING THE MENU

Operation of mass comparator software menu is intuitive and uncomplicated. The touch panel makes the software operation easy. Pressing a function button or an area on the display initiates an assigned function or process.

8.1. Buttons

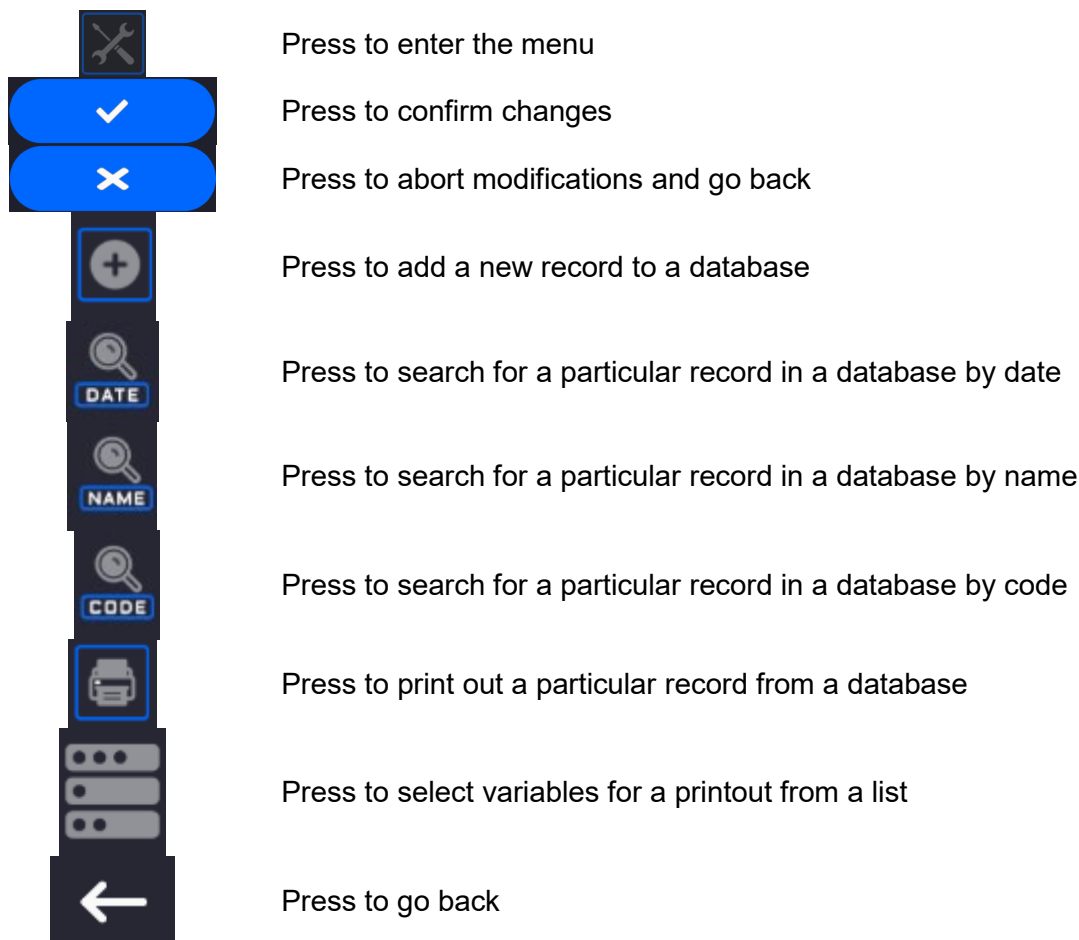

8.2. Voice Commands

The mass comparator enables some selected operation to be triggered by voice: taring, zeroing, measurement print/save. The commands must be said in English in a specified format.

Commands format:

Tarring: **ellipsis** [please] (tare | tar | terre) [the] device

Zeroing: **ellipsis** [please] zero [the] device

Print/save: **ellipsis** [please] save [the] (mass | measurement | mass measurement)

Command articulation method: text in black – compulsory, text in green – voluntary, text in red – one of three compulsory, e.g.: for Print command: **ellipsis** save **mass**.

Procedure:

1. Add voice command triggering button, , to the toolbar (for detailed procedure on how to add buttons read later sections).

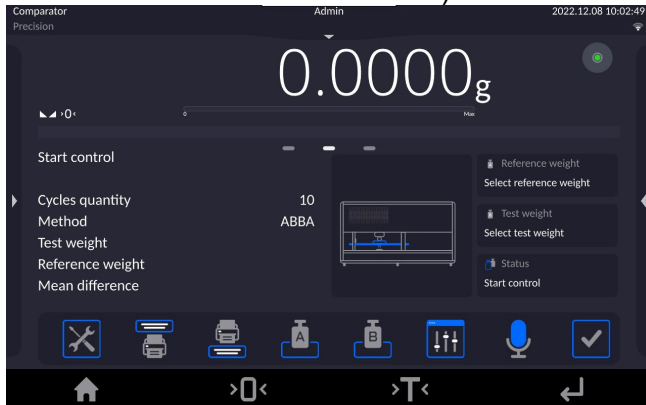

2. Press  button.
3. Procedure of voice command recognition starts, the user is provided with respective information by display of proper messages.

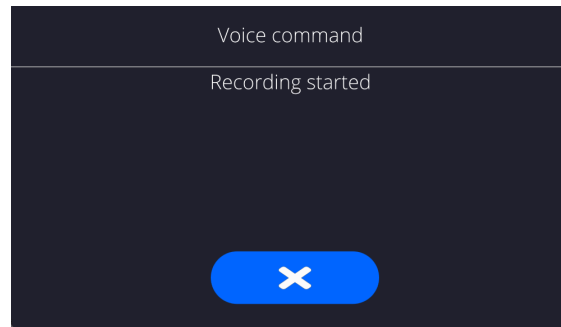
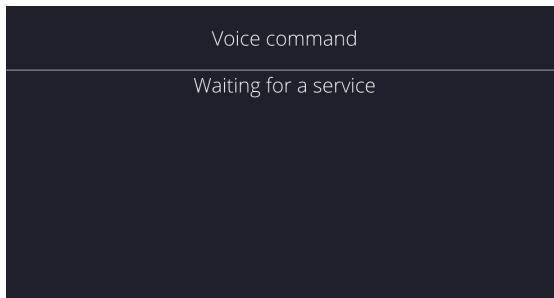

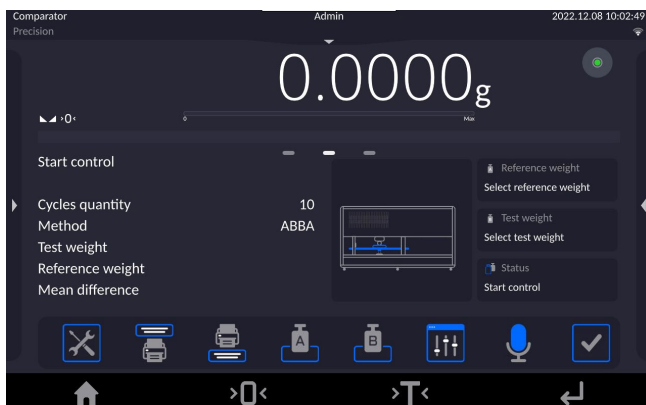
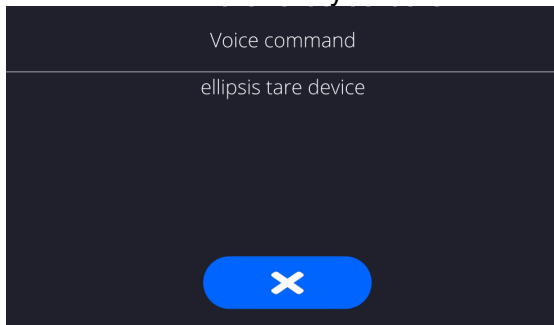

4. Articulate the command following the above instruction.
5. Correctly articulated and recognized command results with display of the message, the command is automatically carried out.



8.3. Return to the Comparison Mode

Any changes made in mass comparator's memory are automatically saved upon returning to the home screen. To return to the home screen:

Procedure:

- Press  key repeatedly, keep pressing the key until you see the home screen.
- Press  key, the home screen is displayed immediately.

9. COMPARISON

Load the weighing pan with a test weight. Read the weighing result upon display of  icon, the icon is displayed on the left.

To record/print the weighing result, press <PRINT> button:

In the case of verified mass comparators only stable weighing result is printed/recorded ( icon).

9.1. Selecting Comparison Unit

Change of comparison unit is carried out by pressing the weighing unit pictogram visible next to the value of measurement result. Upon pressing the weighing unit, list of available units is displayed. Select the unit you need, the software automatically recalculates indicated value.

Options:

| <i>unit</i> | <i>denotation</i> | <i>verification</i> | <i>unit</i> | <i>denotation</i> | <i>verification</i> |
|-------------|-------------------|---------------------|-----------------|-------------------|---------------------|
| gram | [g] | yes | Taele Hongkong | [tlh] | no |
| milligram | [mg] | yes* | Taele Singapore | [tls] | no |
| | | | Taele Taiwan | [tit] | no |
| carat | [ct] | yes* | Taele China | [tlc] | no |
| pound | [lb] | no | Momme | [mom] | no |
| ounce | [oz] | no | Grain | [gr] | no |
| ounce Troy | [ozt] | no | Newton | [N] | no |
| pennyweight | [dwt] | no | Tical | [ti] | no |

* - unit accessibility conditioned by the mass comparator type

For non-verified mass comparators all non-SI units are available.

9.2. Correct Comparison Principles

To assure long-term operation and correct comparison of the weights, follow the rules presented below:

- Remember to run the mass comparator with unloaded weighing pan

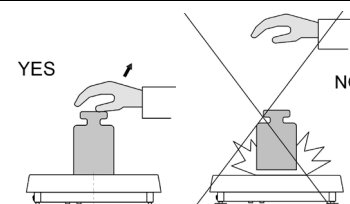
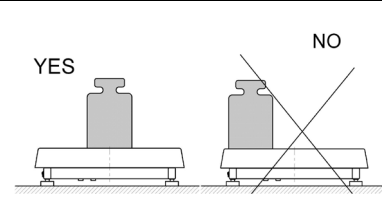

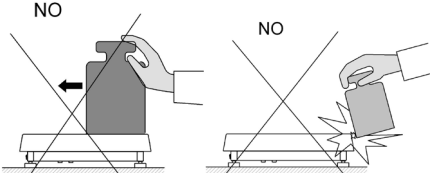
| | |
|---|--|
|  |  |
| <p>Avoid applying mechanical shocks to the weighing pan.</p> | <p>Place loads centrally on the weighing pan:</p> |

| | |
|---|--|
|  | |
| <p>Avoid side loading, in particular side shocks:</p> | |

9.3. Mass Comparator Levelling

The mass comparator features AutoLEVEL System, which continuously monitors its level status. The level status is signalled on the top of the display and on detecting any change it indicates appropriate information and/or starts an alarm. As a result, a window for adjusting the level is displayed.



Procedure:

- Press level status  pictogram located on the top of the display.
- Control panel of levelling function is displayed.
- Level the mass comparator, to do it turn the feet in a way indicated by blinking  pictograms on the display – the level point moves towards the centre of the level circle.
- As the level point takes central position, its colour changes from red to green, , which is a confirmation for correct level status.

Caution:

The device is equipped with a mechanism for Automatic Level Control. For detailed description read later sections of this manual.

9.4. Zeroing

To zero mass indication, press  key. Zero indication and the following pictograms are displayed:  and . Zeroing operation means determining new zero point, recognized by the weighing device as precise zero. The instrument can be zeroed only when the indication is stable and the weighing pan loaded.

9.5. Taring

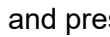
To determine net weight value, load the weighing pan with a packaging, wait for a stable indication and press  key. Zero indication and the following pictograms are displayed: **Net** and . Upon unloading the weighing pan, the sum of tared masses with minus sign is displayed. You can assign tare value to a particular product stored in the database. In such case the assigned tare value is automatically acquired upon selection of the given product .



Caution:

*It is impossible to tare negative values. When you try to tare negative values, the weighing instrument responds with an error message: **Err3**. In such case, zero the indication and repeat taring procedure.*

Entering tare value manually

Procedure:



- Press  quick access key. The key is available regardless of the working mode you currently operate.
- An on-screen numeric keyboard is displayed.
- Enter tare value and press  key.
- The mass comparator returns to the comparison mode, and the display indicates entered tare value with minus sign, „-“.

Deleting tare

The tare value indicated on the display can be deleted by pressing ZERO key on the operation panel, or by pressing programmable <Deactivate tare> function key.

Procedure 1 - upon taking the tared load off the weighing pan:

- Press ZERO key,
- The NET marker gets deleted, new zero point is determined.

Procedure 2 - with tared load on the weighing pan:

- Press ZERO key,
- The NET marker gets deleted, new zero point is determined.
- When the tare value exceeds 2% of the maximum capacity, Err message is displayed in order to inform you about the fact that operation cannot be carried out.

Procedure 3 - when the tared load is on the weighing pan or upon taking the tared load off the weighing pan:



- Press programmable key <Deactivate tare> ,
- The NET marker is deleted.
- The display indicates tare value.



- Press <Restore tare>  key to restore the last tare value.

9.6. Running Working Mode

Procedure:

- Click start-menu

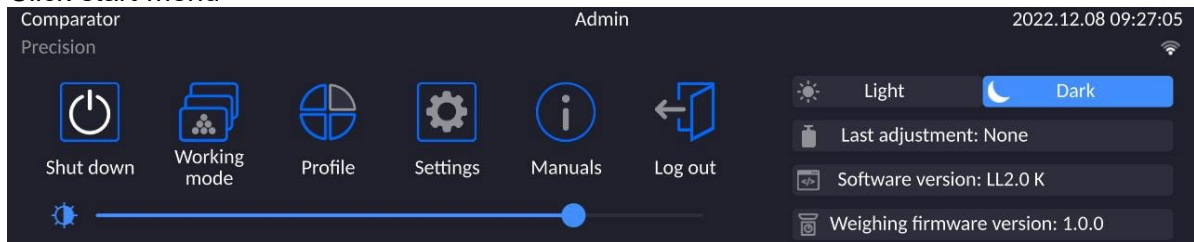

- Click <Working modes> icon.
- List of working modes is displayed.
- Select <Comparator> mode. The software automatically returns to the home screen and displays name of selected working mode in the top bar.
- The following message is displayed in the work pane: <Start control>.
- Select internal and external loads (depending on mass comparator type) suitable for mass of calibrated standard.
- Load the weighing pan with an appropriate reference weight.
- Zero/tare the mass comparator indication.

9.7. Working Mode Parameters – Comparator

Each working mode features programmable parameters, determining the given mode functionality.

Access procedure:

1. Click drop-down menu on the left

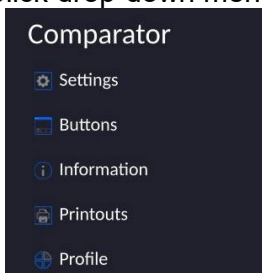

2. List of menu options is displayed:

- <Settings> - extra mode-related options.
- <Buttons> - quick access key defining.
- <Information> - data to be displayed in Info field.
- <Printouts> - printout type and content.
- <Profiles> - defined user profiles.

3. Click option of your choice and select the component that is to be modified.

Description of basic parameters of <Settings> menu is to be found further down this user manual.

9.8. Quick Access Keys, Proximity Sensors

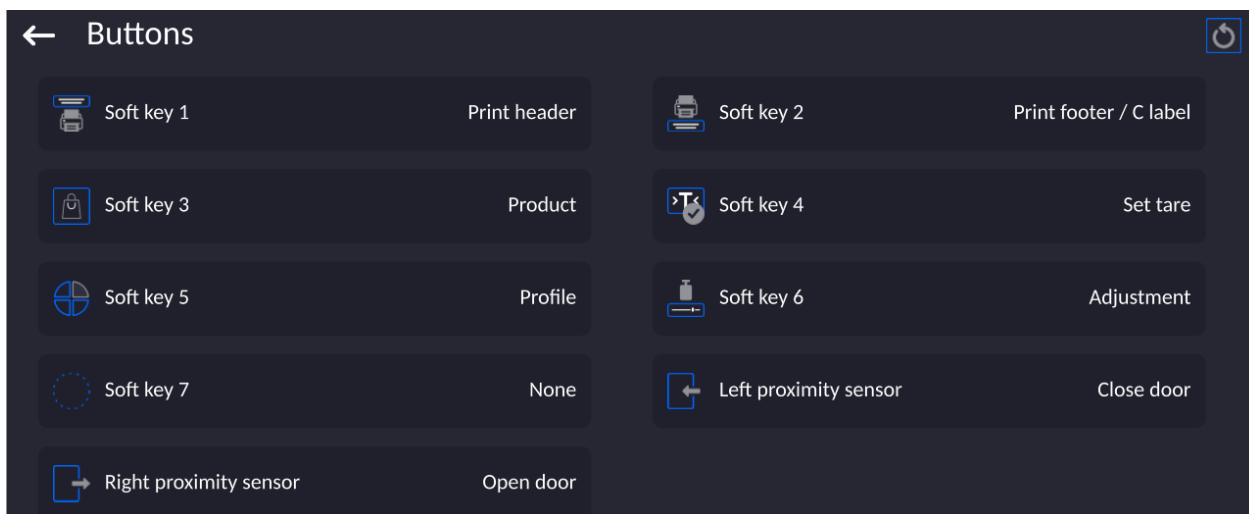

You can quickly restore default key arrangement in the bottom bar of the display, to do it click  button (top right-hand corner).

The user can define 7 buttons that can be displayed in the bottom bar of the display. After assigning a button with a function, respective icon is shown in the navigation bar of the main display. The button availability is conditioned by a working mode. List of buttons is to be found in APPENDIX B.

Another method for adding or changing the button is to press and hold the field in the button bar for about 3 s.



Available button window is displayed automatically

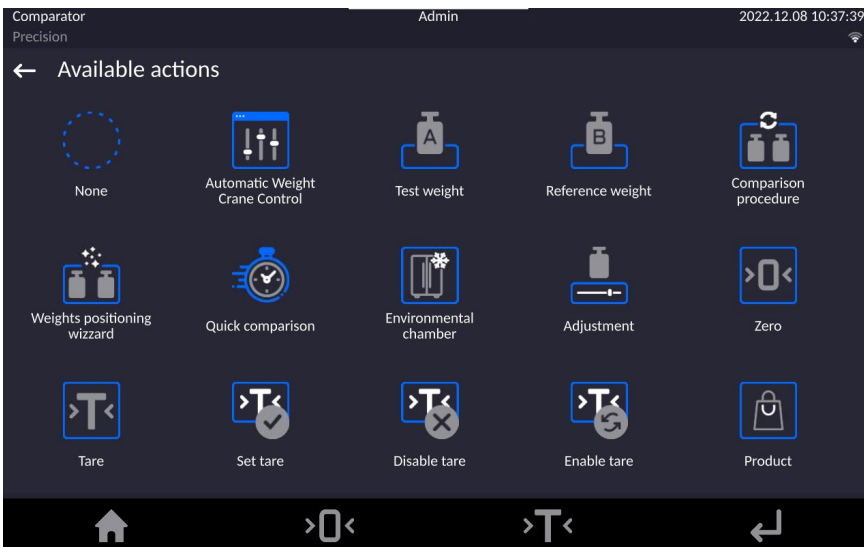

Click the button that is to be added, the home screen is displayed automatically, the selected button appears in the field that has been activated.

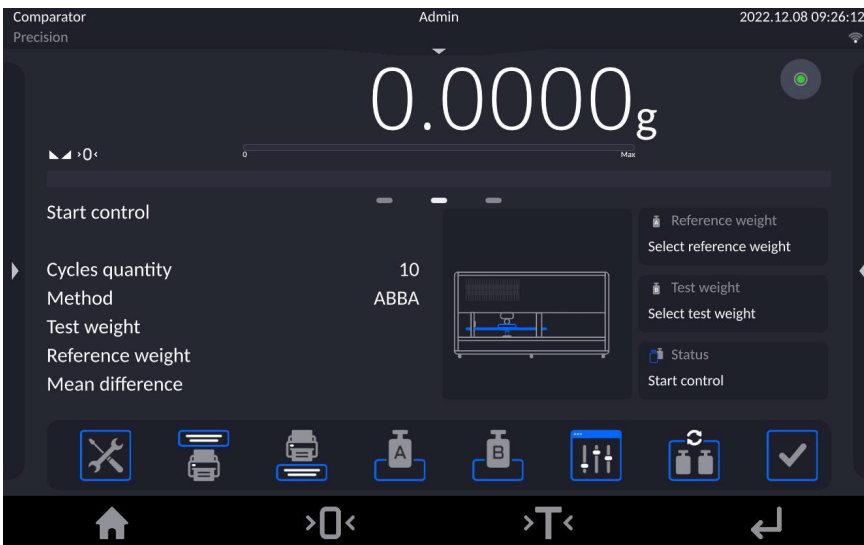

9.8.1. Proximity Sensors

The device is equipped with two proximity sensors allowing control touch free. The program recognizes 2 different movement states:

1. Hand movement near the left sensor <Left proximity sensor>.
2. Hand movement near the right sensor <Right proximity sensor>.

9.9. Working Mode – Comparator

<Comparator> working mode enables determining standard deviation for series of measurements. Standard deviation is determined based on ABBA, ABA or AB series of measurements, where:

- A – reference weight
- B – test weight

You can determine quantity of measurements in a series and ABBA, ABA or AB method. To do that, enter <Working modes> menu and <Comparator> submenu.

The results are calculated on the basis of the following tables and formulas:

For ABBA series

| No. | A | B | B | A | $D = B_{\text{mean}} - A$ |
|-------|---|---|---|---|---------------------------|
| 1 | | | | | D_1 |
| 2 | | | | | D_2 |
| 3 | | | | | D_3 |
| 4 | | | | | D_4 |
| 5 | | | | | D_5 |
| | | | | | ... |
| n | | | | | D_n |

For ABA series

| No. | A | B | A | $D = B - A_{\text{mean}}$ |
|-------|---|---|---|---------------------------|
| 1 | | | | D_1 |
| 2 | | | | D_2 |
| 3 | | | | D_3 |
| 4 | | | | D_4 |
| 5 | | | | D_5 |
| | | | | ... |
| n | | | | D_n |

For AB series

| No. | A | B | $D = B - A$ |
|-------|---|---|-------------|
| 1 | | | D_1 |
| 2 | | | D_2 |
| 3 | | | D_3 |
| 4 | | | D_4 |
| 5 | | | D_5 |
| | | | ... |
| n | | | D_n |

Standard deviation is calculated by determining:

- ABBA and ABA differences for each measurement group:

$$D_i = \bar{B} - \bar{A}$$

- Mean value of difference between ABBA and ABA:

$$\overline{DX}_i = \frac{1}{n} \sum_{i=1}^n D_i$$

- Standard deviation:

$$s = \sqrt{\frac{1}{n} \sum_{i=1}^n (D_i - \overline{DX}_i)^2}$$

9.10. Selecting Measuring Method in Mass Comparator

Particular working modes settings feature specific functions. The functions enable adapting mode operation to your individual needs. Working modes can be configured in **<Working modes>** submenu. To enter **<Working modes>** submenu click drop-down menu on the left.

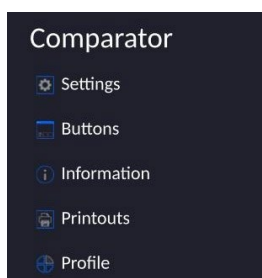

Press **<Settings>** key, working mode edit box is displayed:

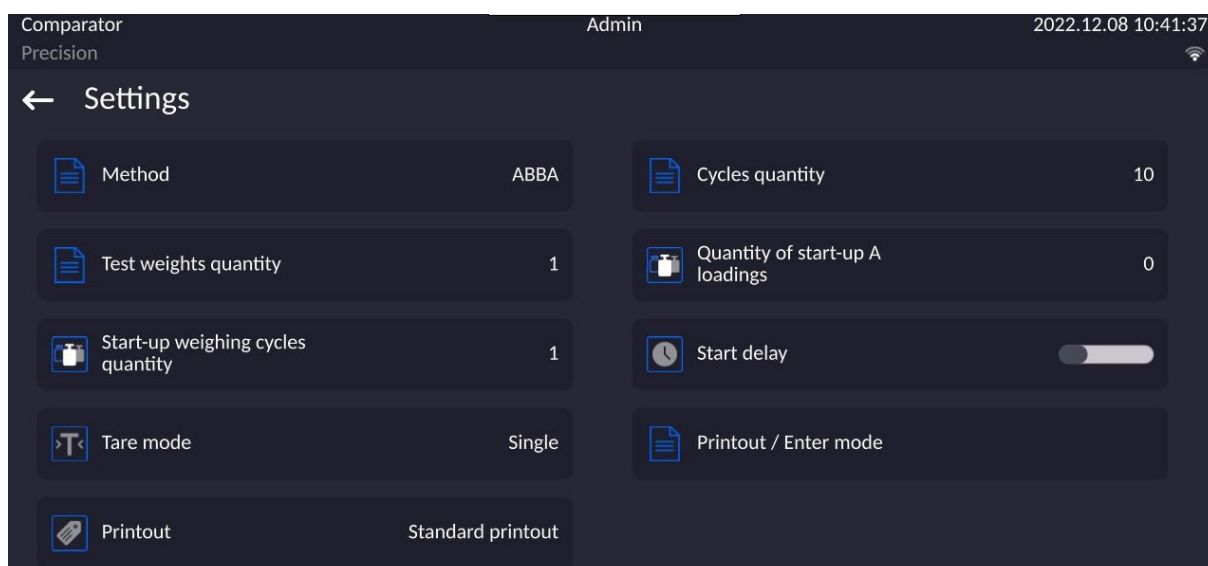

In order to change the method of weights comparison, press **<Method>** and select method from the list:

- ABBA
- ABA
- AB

9.11. Determining Cycle Quantity

Procedure:

- Select **<Comparator>** and press **<Settings>**
- Press **<Cycles quantity>** key, enter the quantity of weighing cycles and press  key to confirm.

9.12. Determining Quantity of Start-up Weighing Cycles

Procedure

- Enter **<Working modes>** submenu,
- Select: **<Comparator>** entry, next press **<Settings>** and **<Start-up weighing cycles quantity>** entries. Edit box **<Start-up weighing cycles quantity>** and an on-screen keyboard are displayed,
- Enter respective value and press  key to confirm.

9.13. Start Delay

- Enter **<Working modes>** submenu,
- Select: **<Comparator>** entry, next press **<Settings>** and **<Start delay>** entries. Edit box is displayed.
- Enter respective value:
 - YES – at comparison start edit box for entering delay value is displayed, comparison starts automatically after the set time,
 - NO - procedure starts immediately, without delays. Upon selecting the respective option, the edit box is closed, and description next to the parameter changes.

9.14. Tare Mode

- SINGLE,
mass value saved to mass comparator on single pressing of TARE key. Subsequent pressing of TARE key determines new value of tare. Selecting product or packaging to which tare value is assigned causes automatic deleting of previously assigned tare value.
- SUM OF CURRENT,
totalizing currently entered tare values for product and packaging (resulting from products and packaging selection out of the database) with possibility to add tare value entered manually. Upon determining tare value for a product or a packaging again, the tare value introduced manually is deactivated.
- SUM OF ALL,
totalizing of all entered tare values.
- AUTOTARE
Means of operation:
Each first stable measurement result is tared. The NET pictogram is displayed. You can now determine net weight. Upon unloading the weighing pan and autozeroing, Tare value is automatically deleted.

9.15. Printout/Enter Mode

- PRINTOUT / ENTER KEY
 - Never – printout disabled
 - First stable – first stable measurement is recorded
 - Each stable – all stable measurements are recorded
 - Each – printout of all measurements (stable and unstable), for verified mass comparator only stable measurements are printed (as in **<Each stable>** setting)
- AUTOMATIC MODE

Never – printout disabled
 First stable - the first stable measurement is registered; the next stable measurement is registered after unloading the weighing pan, returning the indication to the value below set threshold value and loading the weighing pan again with next weight.
 Last stable - last stable measurement is registered. The record takes place upon unloading the weighing pan and returning the indication to the value below set threshold value.

With interval – interval for sending the indication to be printed out.

- THRESHOLD
 Mass value obligatory for operation of automatic printout, set in grams.
- INTERVAL
 Printout interval.
- PRINT REPORT
 Yes – automatic printout upon completed calibration procedure
 No - printout disabled

9.16. Printouts

This option enables determining standard and non-standard printouts.



- **Standard printout**

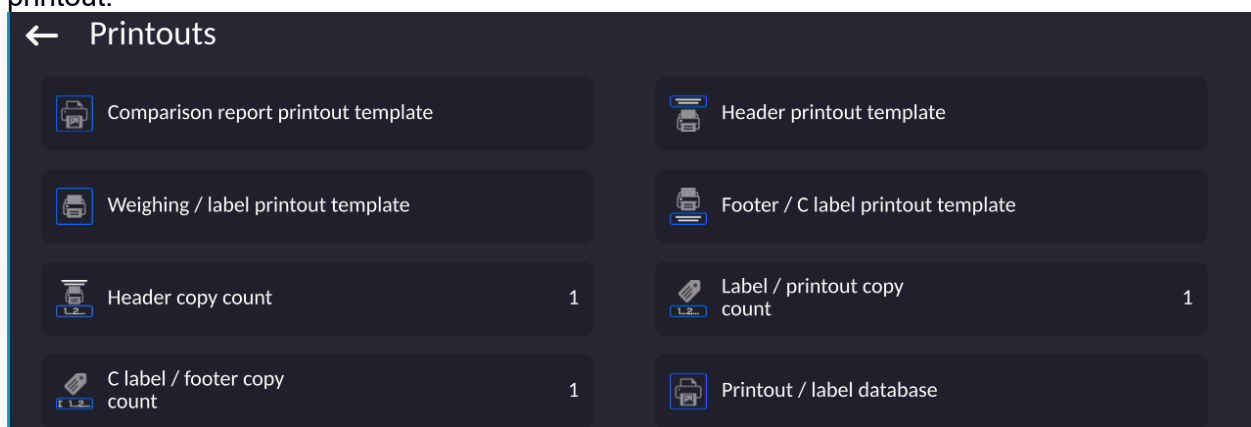

Comprises four internal sections containing different variables. For each variable, the Printout Menu includes two separate components: standard printout, and non-standard printout.

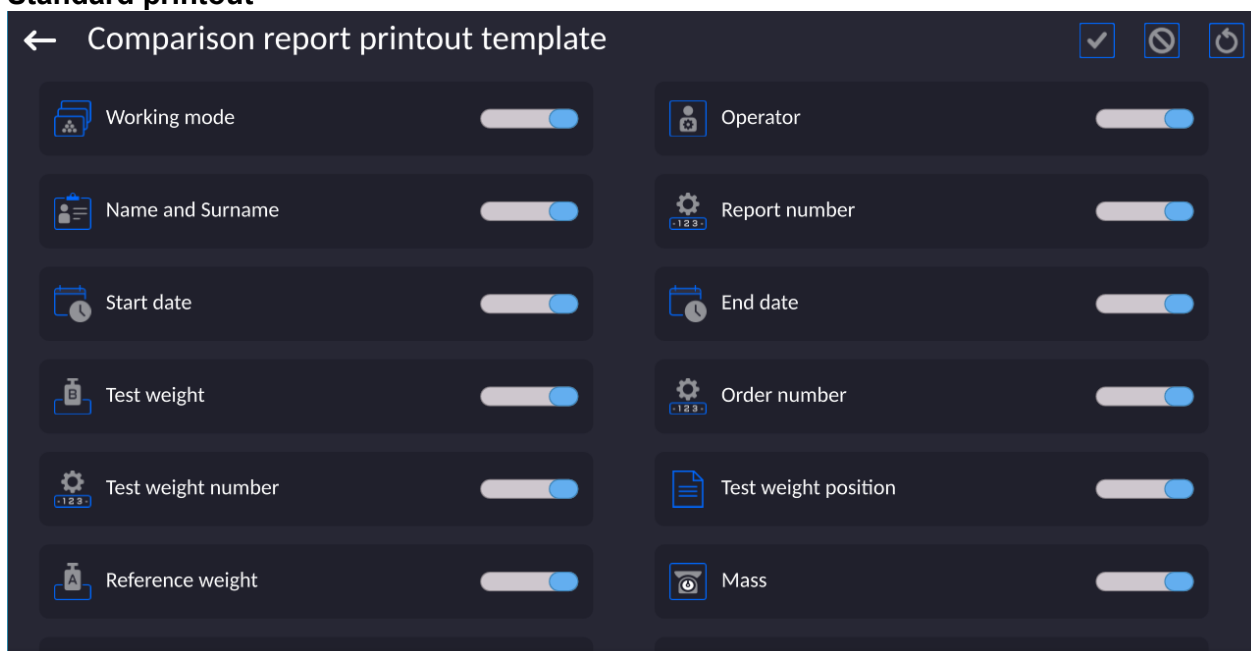

Standard printout



Comprises four internal sections containing different variables. For each variable set option  to include it in a standard printout. If option  is selected, then the variable is disabled, i.e. it is not printed

| | |
|---|---|
|  | Press to deselect all marked variables. |
|  | Press to select all marked variables. |
|  | Press to restore default variables. |

Printout content:

- Working mode
- Operator
- Report number
- Start date
- End date
- Task
- Order number
- Test weight number
- Reference weight
- Mass
- Standard's class
- Measurements
- Mean difference of mass of reference and test weight
- Standard deviation
- Cycles quantity
- Method
- Min temperature during process
- Max temperature during process
- Min humidity during process
- Max humidity during process
- Min pressure during process
- Max pressure during process
- Empty line
- Dashes
- Signature
- Non-standard printout

9.17. Completed Comparison Processes Report

Upon each completed comparison process, a report is generated. The report is saved to **<Comparison reports>** database. The files are named by the date and time (hour) of mass comparison process.

Report template:

Report number C/31/10/11/11/43

End date 2017.05.28 11:44:46

n |A |B |A |D

1 |0.000 |0.131 |0.001 |0.1305

2 |0.002 |0.130 |0.003 |0.1275

3 |0.004 |0.131 |0.004 |0.127



Mean difference 0.12833 g



Standard deviation 0.00189 g

Method ABA

Signature

HOW TO OPERATE PRINTOUTS – BASIC RULES

- To print out variables, with attribute , displayed in WEIGHING section of the standard printout, press  button (see: List of variables).
- Variables with attribute , displayed in HEADER or FOOTER, will be printed ONLY when **Header Printout**, or **Footer Printout** icon is pressed. Header/Footer Printout icons shall be added to bottom display bar as quick access keys. (For instruction on how to add quick access buttons – read section 9.8)

| | |
|---|---|
|  |  |
| Printout of header-comprised information | Printout of footer-comprised information |

Caution:

Units for mass indication printout:

- Net weight – the main unit (adjustment unit)
- Tare – the main unit (adjustment unit)
- Gross weight – the main unit (adjustment unit)
- Current indication – current unit
- Supplementary unit – additional unit
- Mass – the main unit (adjustment unit)

Non-Standard Printout

The printout may comprise: TEXTS and VARIABLES (downloaded form the program at the moment of printout). Each printout is a separate project, individually named, which name identifies the project, and is saved to the database.

Procedure:

- Press <Non-standard printout> entry.



2. Press <Add> button, window with the following data is displayed:
Name/Code/Project.
3. Name the project, provide its code.
4. Press <Project> button.
5. A window, enabling printout editing, with an on-screen keyboard is displayed.
6. Use the keyboard to design the printout, the printout may comprise texts and variables.

Caution:



- It is possible to add printouts from the external storage by import of already configured texts, using the USB port.
- Printout name is ONLY A NAME and does not start for the printout content.

For detailed information on how to design the non-standard printout read later sections of this manual.

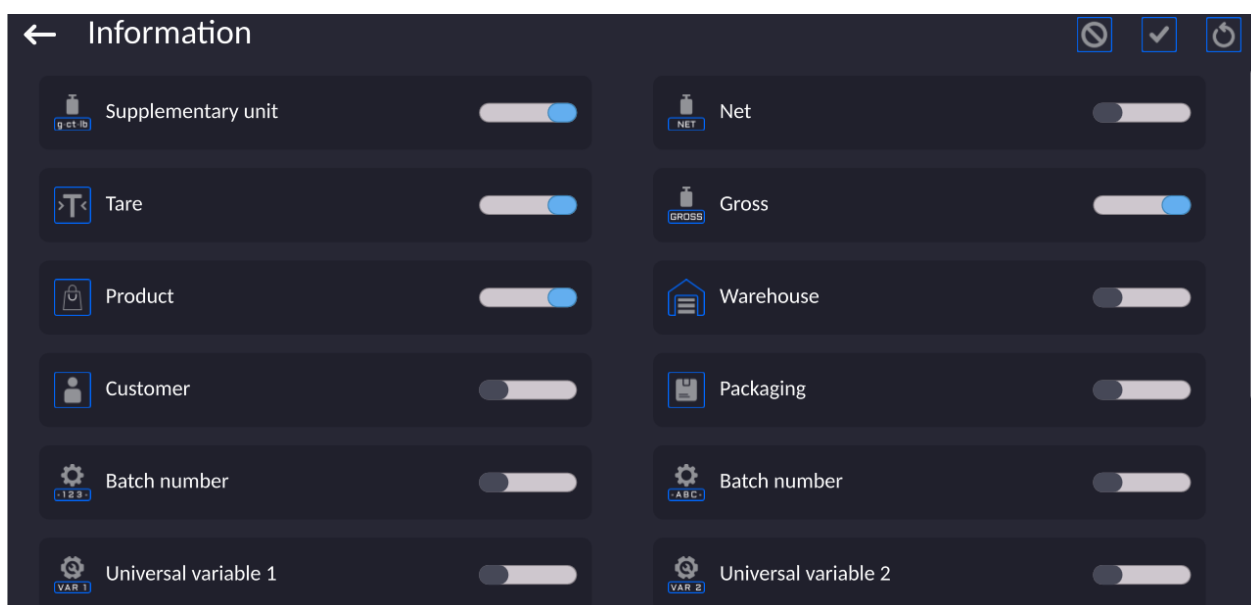
9.18. Managing the Display Information and Shortcut Keys



You can quickly select/deselect info to-be-displayed, to do it use top right-hand corner buttons.

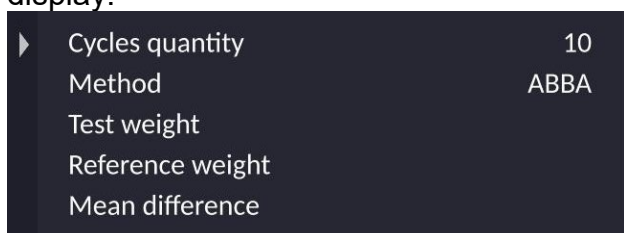

| | |
|---|---|
|  | Press to deselect all marked information. |
|  | Press to select all marked information. |
|  | Press to restore default settings. |

Information on the weighing process are displayed on the left of the middle section of the display.







The section can feature up to 6 data maximum. Shall more than 6 data be selected, only the first 6 will be shown.



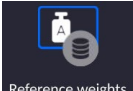

Each data features two options:

-  – information on.
-  – information off.

9.19. Mass Comparison Process - Basic Procedure

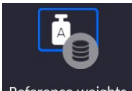
1. Go to the home screen, press  (lower left corner of the screen).
2. Select Database.
3. Enter Reference weights, , define reference weights.
4. Return to the Database, enter Test weights, , define test weights.
5. Return to the Database, define Comparison Procedure,  .
6. Return to the home screen, press Comparisons Procedures entry, , located on the function button's bar, select Comparison Procedure.
7. Load the magazine with reference weights and test weights.
8. To start the comparison, go to the home screen and press  - the process starts automatically, in accordance with the previously set parameters.

It is possible to perform comparison of various weights of different nominal values during one comparison procedure. To do this:

1. Define Reference weights, , and Test Weights, , and provide the weight's mass, the comparator will automatically adjust the internal weights.
2. Define the comparison plan,  .
3. Return to the home screen, press Comparisons Procedures entry, , located on the function button's bar, select the Comparison procedure.
4. Load the magazine with reference weights and test weights.
5. To start the comparison, go to the home screen and press  - the process starts automatically, in accordance with the previously set parameters.

10. ADJUSTMENT

Mass comparators feature automatic internal adjustment system which ensures correct measurement accuracy. <ADJUSTMENT> menu contains functions that enable control of operation of mass comparator adjustment process.

10.1. Internal Adjustment

Internal adjustment is carried out by means of an internal adjustment weight. <Internal adjustment> button, when pressed, automatically triggers adjustment process. Upon adjustment process completion respective message, informing about process end and about its status, is displayed.



Caution:

Mass comparator adjustment procedure requires stable conditions (no air drafts, no vibrations), the weighing pan must be unloaded in the course of adjustment.

10.2. External Adjustment

External adjustment is carried out using an external mass standard of the right accuracy and weight value, which value depends on mass comparator type and capacity. Correction is carried out semi-automatically, successive process stages are signalled with prompts.

Procedure:

- Enter <Adjustment> submenu, next select <External adjustment> parameter .
- Message forcing the user to remove weight is displayed. Unload the weighing pan and press  button. Whereas mass comparator determines start mass, **Start mass determination** message is displayed.
- Upon completed start mass determination procedure, message forcing the user to load the weighing pan with a particular weight value is displayed. Load the weighing pan with the required mass and press  button.
- Upon completed procedure, unload the weighing pan and press  button to confirm. Mass comparator returns to the comparison process.

10.3. User Adjustment

User adjustment can be carried out using any adjustment weight mass of which ranges between 0.15 Max and Max. User adjustment and external adjustment procedures are likewise with one exception, before user adjustment start, an edit box for entering mass of the used adjustment weight is opened.

Caution:

User adjustment is possible in the case of mass comparators that are not a subject to conformity assessment (verification).

In order to start user adjustment, enter <Adjustment> submenu and select <  User adjustment > option. Then follow the commands displayed on a screen.

10.4. Adjustment Test

<Adjustment test> function enables comparing the result of an internal automatic adjustment with the value recorded in mass comparator factory parameters. The comparison is used for determining mass comparator sensitivity drift over time.

10.5. Automatic Adjustment

Enter this menu to specify conditions initiating an automatic adjustment. Options:

- None – automatic adjustment inactive.
- Time – adjustment takes place in time intervals declared in menu <Automatic adjustment time>.
- Temperature – adjustment is triggered by temperature change.
- Both – adjustment is triggered by both, temperature changes and time.

10.6. Automatic Adjustment Time

<Automatic adjustment time> parameter determines time interval between successive automatic internal adjustments. The time interval is declared in hours and ranges between 1 and 12 hours.

To set time interval for automatic adjustment:

- Select <Automatic adjustment time> option.
- Using displayed menu, select appropriate time interval (given in hours) which is to elapse between the most recent adjustment and activation of the following automatic internal adjustment.

10.7. Report Printout

<Report printout> parameter determines whether or not an adjustment report is to be automatically printed upon adjustment process completion.

In order to set automatic report printout, set the parameter on.

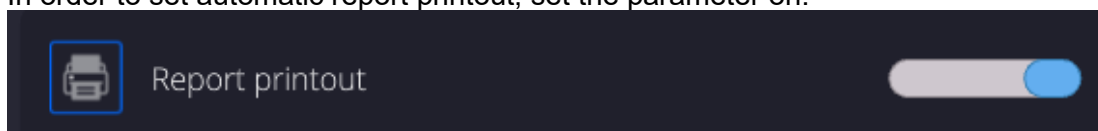

10.8. GLP Project

GLP is one of many methods for documenting work in accordance with adopted quality system. Data selected for printing is printed on each release of an adjustment report.

Information and signs to be used in a GLP report:

- Adjustment
- Working mode
- Date
- Time
- Mass comparator type
- Mass comparator S/N
- Operator
- Name and surname
- Level status
- Nominal mass
- Current mass
- Difference
- Temperature
- Dashes
- Empty line
- Signature
- Non-standard printout

10.9. Adjustment History

Adjustment history contains data on all carried out adjustment processes. The record is carried out automatically. Each record on adjustment comprises basic data on completed process. This menu enables displaying the list of completed adjustment processes. Each report is printable.

In order to print an adjustment report, enter <Adjustment> submenu, next enter <Adjustment



history>, select adjustment to be printed. Upon displaying record details, press < print key located on the top of the display.

Caution:

If the mass comparator memory is full then the oldest record gets automatically deleted.

If internal procedures of an organization require maintaining complete documentation from all carried out adjustment processes, then the list with adjustment records has to be printed and archived periodically.

Searching for adjustment record

Mass comparator enables searching for a specific completed adjustment record. To do that, press

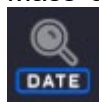

search pictogram and enter date of adjustment process that is to be found.

Exporting data on completed adjustment process

Connect a USB flash drive to mass comparator's USB port. Press <Data export> button located on the top of the display. The process is fully automatic and on its completion a file with **.db** extension is saved on a USB flash drive connected to the USB port.

11. ADMINISTRATOR PANEL

This parameter group determines set of activities to be performed by a particular operator assigned with a respective permission level, password security, and unlogged user rights.

CAUTION: The Administrator Panel can be modified by the Administrator exclusively

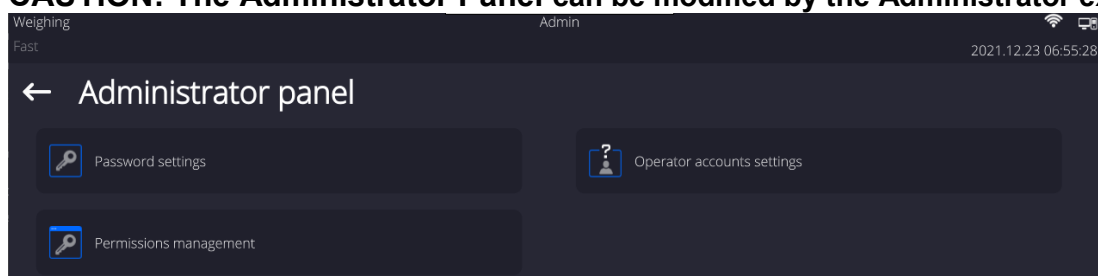

11.1. Password Setting

This parameter group enabling user to determine the password complexity.

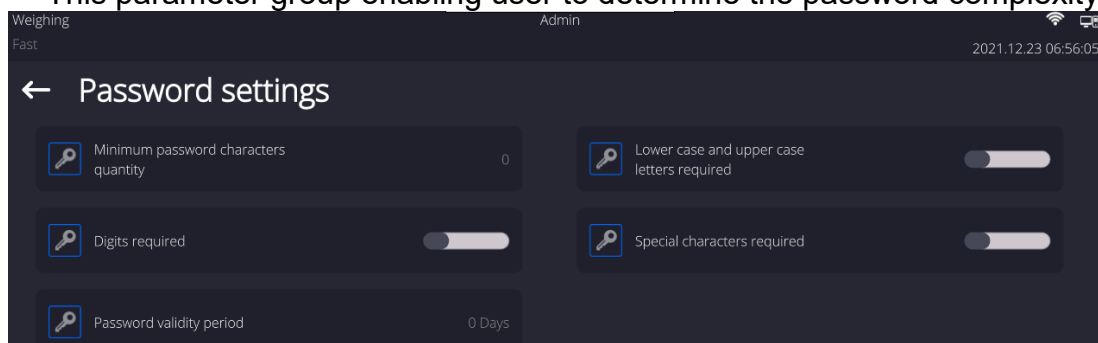

| | |
|---|---|
| Minimum password character quantity | Parameter specifying minimum quantity of characters the password should contain With „0” value set, any quantity of characters can be used. |
| Lower case and upper case letter required | Parameter specifying requirements for password character content and format. |
| Digits required | |
| Special characters required | |
| Password validity period | Parameter specifying time interval, given in days, after passage of which the password is to be changed. With „0” value set, password change is not required by the program. |

11.2. User Account Setting

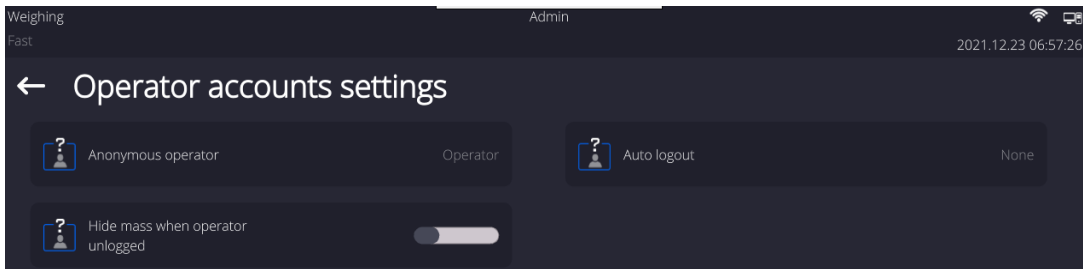

Anonymous Operator

Parameter allowing Administrator to assign unlogged weighing device operator (so called anonymous operator) with permissions

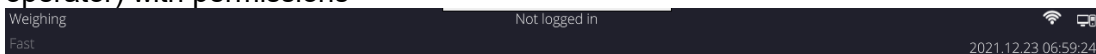

Procedure:

Enter <Operator account settings> parameter group, select <Anonymous operator> entry, next set one of 4 options: Guest, Operator, Advanced operator, Administrator.

Caution:

When <Guest> option is set, the software settings cannot be modified by unlogged operator.

Auto Logout

Auto logout parameter has been designed to trigger logout operation when the mass comparator stays inactive for specified time interval given in minutes.

Default parameter setting: <None>.

Procedure:

Enter <Operator account settings> parameter group, select <Auto logout> entry, next set one of available options: none/3/5/15/30/60. Time given in [min].

Hide Mass When Operator Unlogged

Parameter allowing to disable mass display if the user is not logged in. By default this option is off.

Procedure:

Enter <Hide mass when operator unlogged> option, next switch the option on.

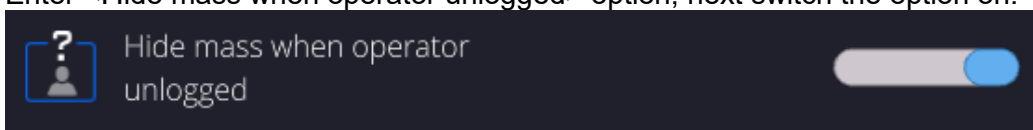

11.3. Permissions Management

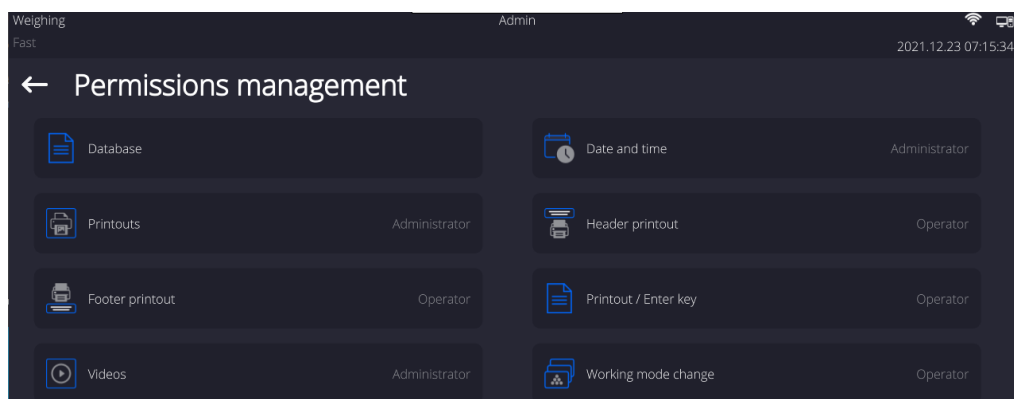

Caution:

When <Guest> option is set for a selected parameter, the access to its settings is free.

For each option one of 4 available permission levels can be assigned:

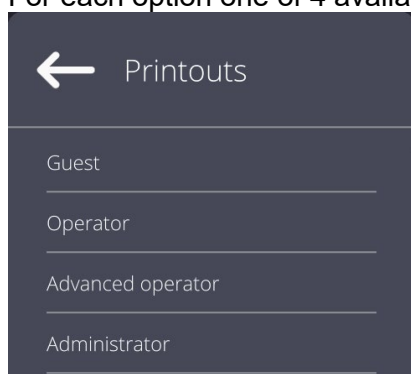

Databases

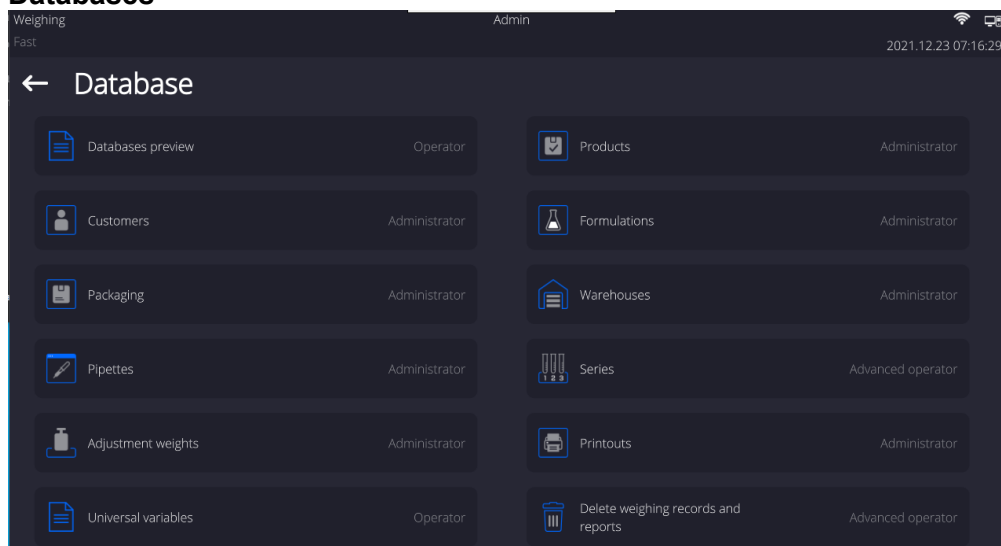

Default balance settings allow **Administrator** to modify particular database settings. Depending on the requirements the settings can be changed.

Permission levels can be modified for the remaining options of the above menu.

12. PROFILES

A new profile can be created via Administrator exclusively.

There are two methods:

- making a copy of an existing profile and modifying it,
- adding a new profile.



Copying an existing profile

Procedure:

- Enter the main menu, to do it press  button.
- Enter  submenu.
- Press and hold profile that is to be copied.
- Menu referring to a profile record is displayed. Select <Copy> parameter.
- A new <Copy name> profile is created, new profile settings and base profile settings are identical.
- Modify necessary data: (name, etc.).

Adding a new profile

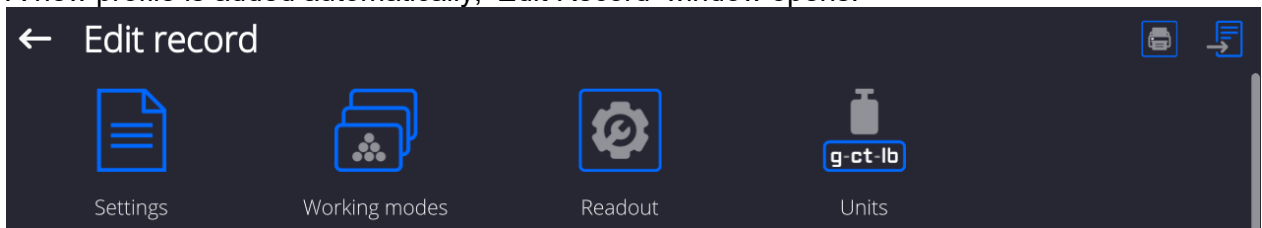

Procedure:

- Enter the main menu, to do it press  button.
- Enter  submenu.
- Press  key.
- A new profile is added automatically, 'Edit Record' window opens.



Deleting a profile

Procedure:

- Enter the main menu, to do it press  button.
- Enter  submenu.
 - Press and hold profile that is to be deleted.
 - Profile menu is displayed. Select <Delete> parameter.
 - Message box: <Delete?> is displayed.
- Press  key to confirm, the profile gets deleted.

Caution:

In order to carry out operations for profiles, it is necessary to log in as an Administrator.

12.1. Profile Structure

Each profile contains the following entries:

- Settings** Enter this menu to set an individual profile name (an order of alphanumeric characters), and to declare a default working mode (the selected mode is activated as default upon selecting the profile).
- Working Modes** Contains the following submenus:
- Additional settings of a working mode
 - Buttons
 - Information
 - Printouts
- Readout** Contains the following submenus:
- Filter
 - Value release
 - Autozero
 - Last digit
 - Ambient conditions
- Measuring units** Enter this menu to declare the start unit, the supplementary unit, 2 custom units and to enter the value of gravitational acceleration force in mass comparator's operation place.

12.1.1. Settings

Name

Upon entering this option, a message box with keyboard is displayed. Enter the name of a profile and press  button to confirm. The name is assigned to the profile.

Default working mode

Upon entering this option you can select a specific working mode, which is set as default in a profile. For <None> parameter set, upon selecting the profile, the mass comparator activates the most recently used working mode.

12.1.2. Working Modes

Upon entering Working Modes option, a window containing all accessible working modes is displayed. Each working mode can be user-modified, particular user settings are loaded upon activation of a particular profile.

List of parameters to be modified:

- Settings:
contains specific parameters relating to a working mode and universal settings, such as: result control, tare mode, automatic footer printout, printout mode, printout
- Quick access keys (buttons):
declaring quick access keys to be visible on the bottom of the display.
- Information:
declaring information to be displayed in the grey workspace.
- Printouts:
declaring type of a printout or defining a non-standard printout.

12.1.3. Readout

The function enables you to adjust mass comparator operation to ambient conditions (filter settings) or your individual needs. <Readout> menu contains the following elements:

FILTER

Each measurement signal before being displayed is electronically processed in order to provide correct parameters specific for stable measurement result, i.e. ready to read.

You can determine signal processing extend, there are five different filters for you to select from. Range:

- very fast, fast, average, slow, very slow.

While setting the filter consider the actual operating conditions. In the case of very good operating conditions select average or fast filter, in the case of rough conditions select slow or very slow filter.

Value release (disabled for profiles: Fast, Fast dosing, Precision)

The parameter has been designed to determine when the stability marker is to be displayed.

There are three different settings for value release parameter:



- fast, fast and reliable, reliable.

Caution:

Both parameters, filter and value release, determine how long it takes to obtain stable result.

Autozero

The function has been designed to enable automatic monitoring and correction of zero indication.

If the function is enabled, the subsequent measurement results are compared to each other in constant time intervals. If the results differ less than declared AUTOZERO range, e.g. 1 division, the mass comparator is automatically zeroed, and the markers of stable indication –  and precise zero –  are displayed. Active AUTOZERO means, that each measurement starts from the precise zero point. There are, however, some cases when this function can be a disturbing factor for the measuring process. For instance during very slow load placing or pouring onto the mass comparator's weighing pan. In such case, the correcting system of zero indication may also correct the actual indication of a load placed on the weighing pan.

Accessible settings: **NO** - autozero function disabled
YES - autozero function enabled

Autozero function: Dosing (disabled for profiles: Fast, Fast dosing, Precision)

The function has been designed to set autozero in function of dosing.

Accessible settings: **NO** - autozero function disabled automatically upon Dosing mode activation
YES - autozero function enabled automatically upon Dosing mode activation

Last digit

The function has been designed to enable/disable visibility of the last decimal place of measurement result. Accessible settings:

- **Always:** all digits are displayed.
- **Never:** last digit disabled.
- **When stable:** last digit displayed only when the result is stable.

Last digit quantity

The function has been designed to declare how many last digits are to be disabled. Accessible settings operating in connection with <Last digit> function:

- **1**: one last digit displayed.
- **2**: two last digits disabled.
- **3**: three last digits disabled.

Ambient conditions

Parameter relating to ambient and environmental conditions of the workstation. For unstable ambient conditions it is advisable to set the parameter to value: **Unstable**. Default value: Stable.

Stable setting results with faster operation, i.e. weighing takes much less time than in case of setting to value: Unstable.

12.1.4. Measuring Units

For a selected profile you can declare start unit, supplementary unit and two custom measuring units.

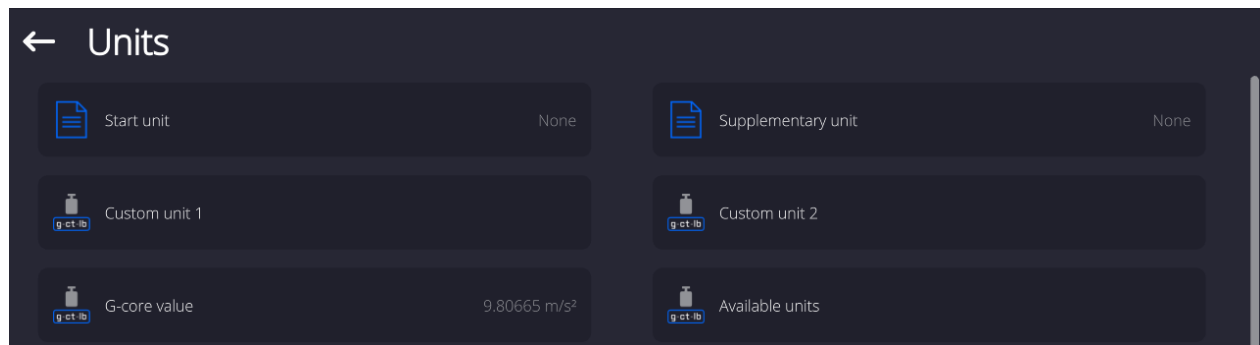

A custom measuring unit features:

- o a formula (custom unit recalculation formula): Factor * Mass or Factor / Mass
- o a factor (coefficient for recalculation of the custom unit in accordance with the selected formula)
- o a name (3 characters maximum)

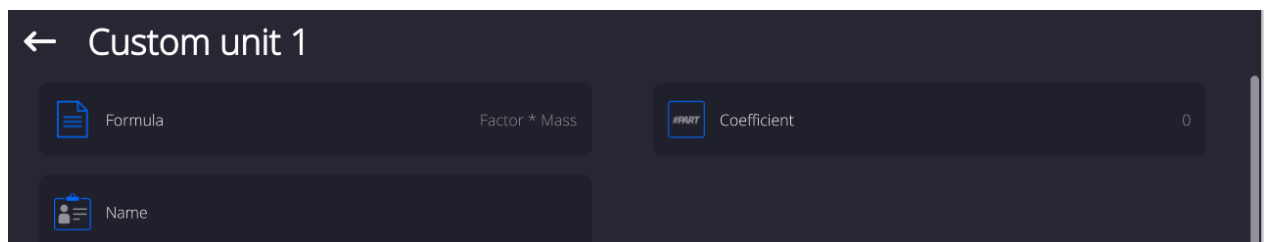

Upon completed operation of designing a custom unit its name is added to the list of accessible measuring units.

Additionally, units menu enables entering the value of gravitational acceleration force for mass comparator's place of use. It is obligatory should a mass comparator be used to determine mass in [N].

13. DATABASES

Mass comparator software features the following databases:

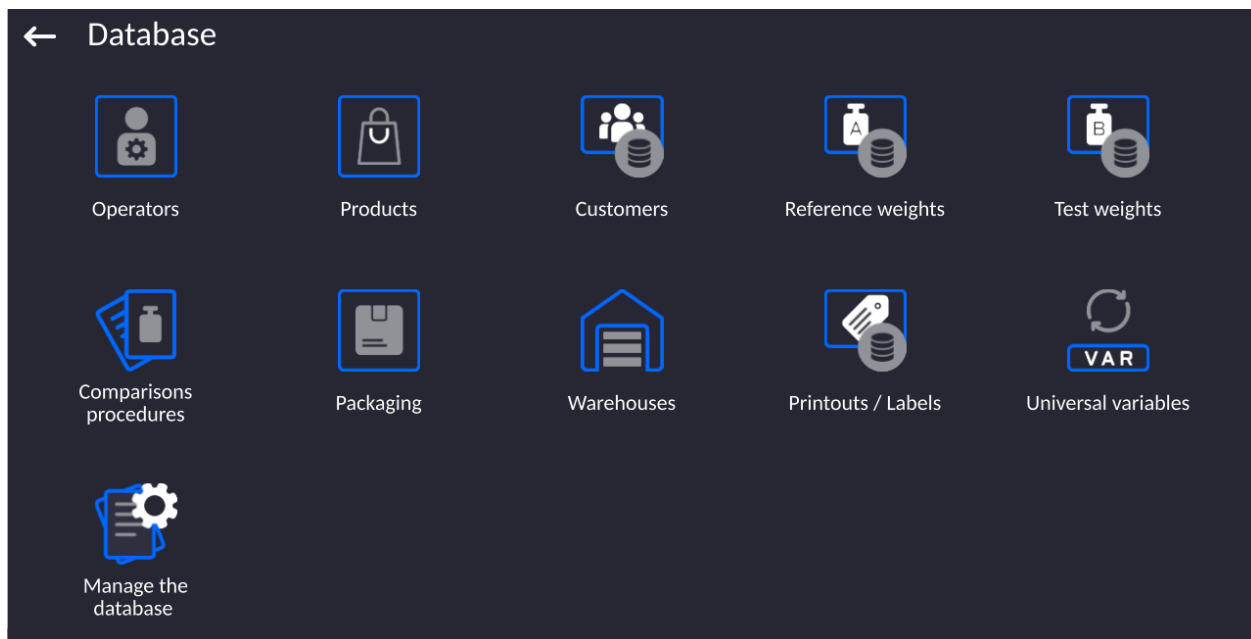

13.1. Processes Carried Out on Databases

Databases can be operated only by an authorized personnel.

Procedure:

- Press and hold for a moment a button with a respective database pictogram.
- Wait to see a menu.
- Select one of available options (options depend on a database type).

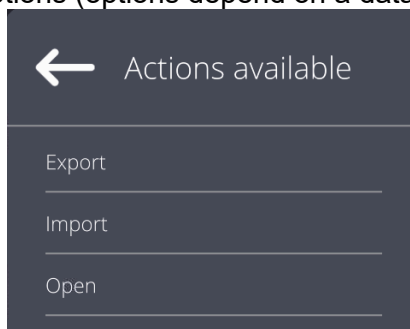

Options overview:

- **OPEN** – option allows you to enter a database (result is similar to the one obtained by a single click).
- **IMPORT** – option allows you to import data from a USB flash drive. Plug the USB flash drive to a USB port, upon its detection a window with a list of saved files is displayed. Select file with data to be imported. The copying starts automatically. Upon completion of the process a message: <Completed> is displayed. Confirm completion.
- **EXPORT** - option allows you to export data from a selected database to a USB flash drive. Plug the USB flash drive to a USB port, upon its detection the software automatically starts a copying process. Upon completion of the copying process a window with both, a file name to which data has been saved and message: <Completed> is displayed. Confirm completion.

The following operations, depending on the database, can be carried out:

1. Adding entry to a database.
2. Searching for a record in a database by name.

3. Searching for a record in a database by code.
4. Searching for a record in a database by date.
5. Exporting database content to a USB flash drive via USB port.
6. Printing data on a specific record in a database.

The above operations are carried out by pressing dedicated soft keys located on the top of the display. Follow the displayed commands.

13.2. Operators

Operators database features list of users permissioned to operate the balance. The following data can be defined for each balance operator:

| | |
|---------------------|-------------|
| ID | Name |
| Code | Password |
| First and last name | Permissions |
| Active account | Language |
| Default profile | Card number |
| Theme | |

CAUTION: Only a user with Administrator status can add new operators or delete operators from the database.

In order to add an operator:



- Enter <Operators> menu, press <  > button.
- Define all necessary data.

Caution: It is possible to search for an operator in a database of operators by code or name.

Log in using a transponder card:

Caution: The RFID reader mounted in the indicator operates at a frequency of 13.56MHz and complies with ISO/IEC 14443 Type A.

Only cards of this standard will be recognised by the reader.

- Enter Operator settings.
- Select <Card no.>

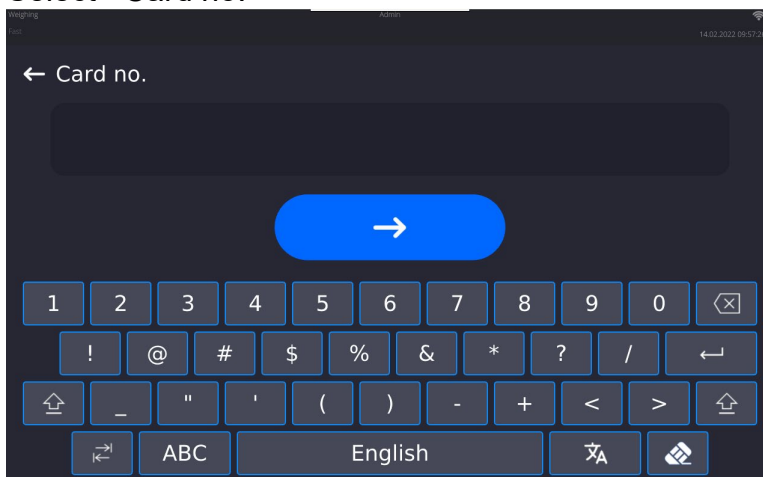

- Apply the card to the RFID reader.

- The card number is automatically entered in the editing field.

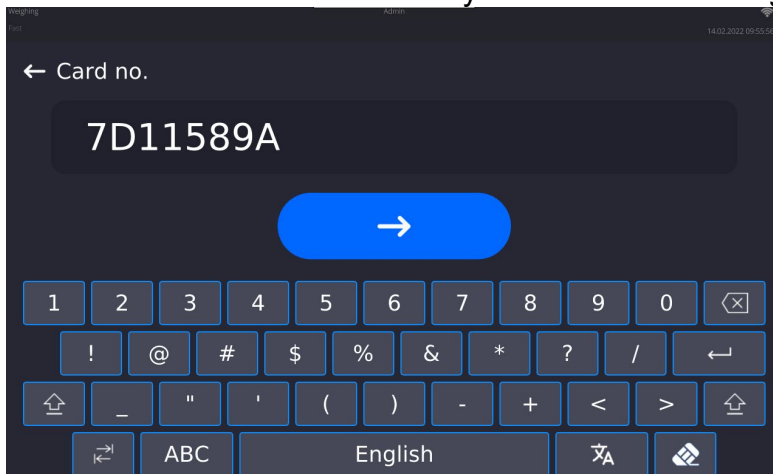

- Press  button, the card number is added to the operator settings.

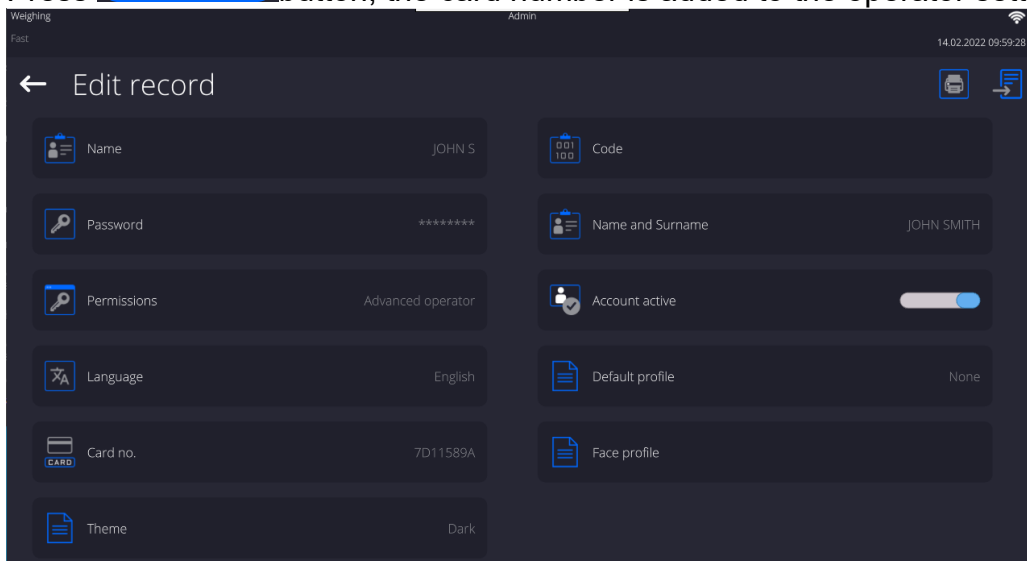

- Exit to the home screen. From now on, applying this card to the RFID reader will automatically log the user in.

Log in using a fingerprint:

Caution: Only the fingerprint reader listed as a dedicated accessory for these balances can be connected to the balance. A list of accessories can be found on RADWAG website.

- When the fingerprint reader is connected to the USB type A socket, the <Fingerprint> option appears in the operator settings menu.

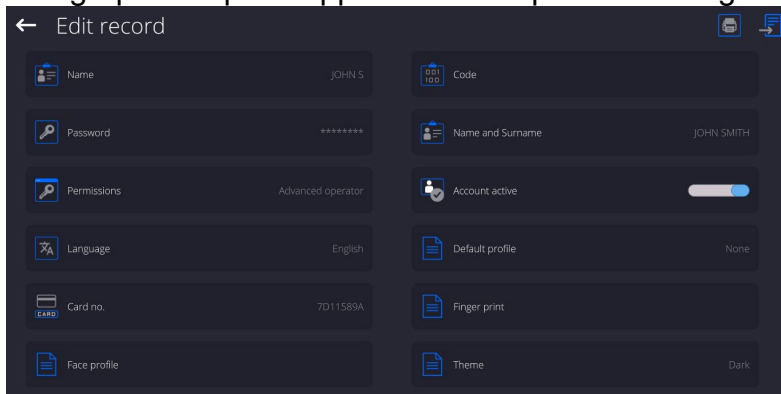

- To add a fingerprint for an operator, enter this option.

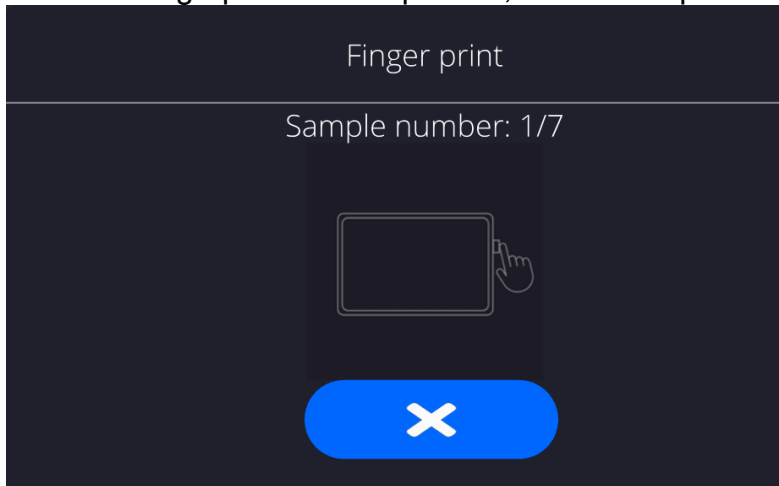

- Scan the fingerprint and repeat the procedure 7 times (as described in the message box).
- When the procedure is completed correctly, a summary window is displayed.

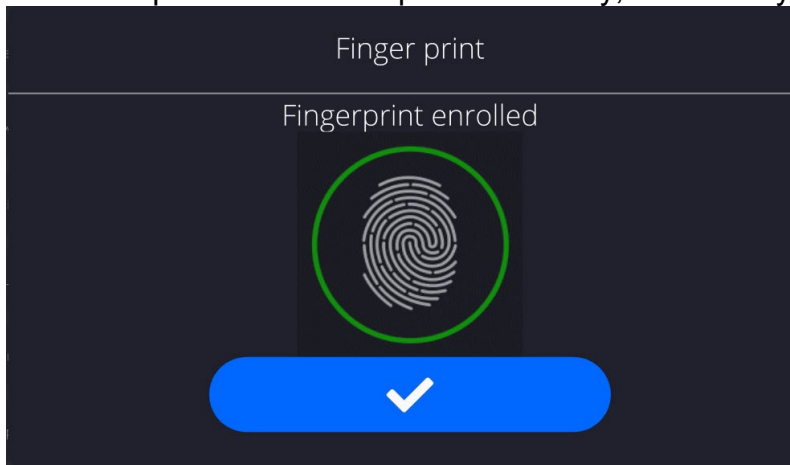

- Confirm the procedure by pressing  button.
- From now on, if a fingerprint reader is connected to the USB port, a pictogram of the active fingerprint login option is displayed in the login window.

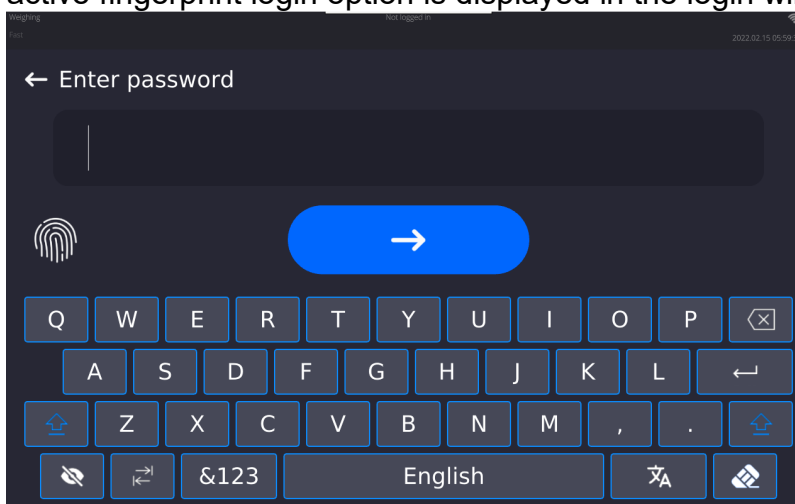

- After placing a finger on the reader and confirming the correctness of the fingerprint with the stored pattern, the pictogram briefly turns green, the user is automatically logged in, and the software switches to the home screen. The name of the logged-in user is displayed in the top bar of the window.
- If the scanned fingerprint does not match the stored pattern, the pictogram briefly turns red, the user is not logged in, and the software displays the login window.

Log in using a face profile:

- To add a face profile for a user, go to the option presented below

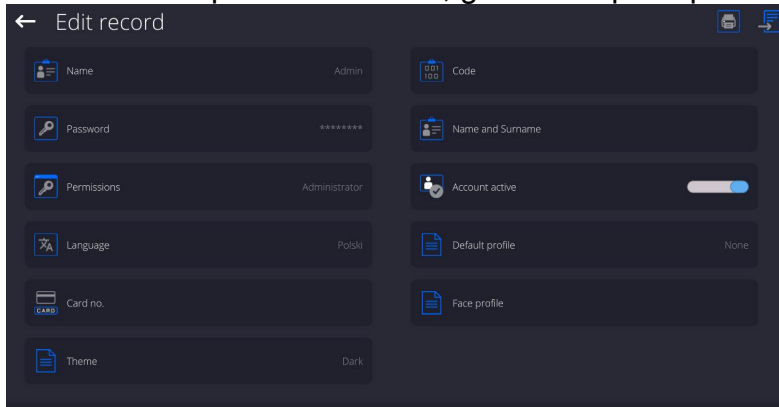

- After starting the option, a message is displayed and the face profile is read; you must position yourself correctly in relation to the camera so that the program can save the profile.

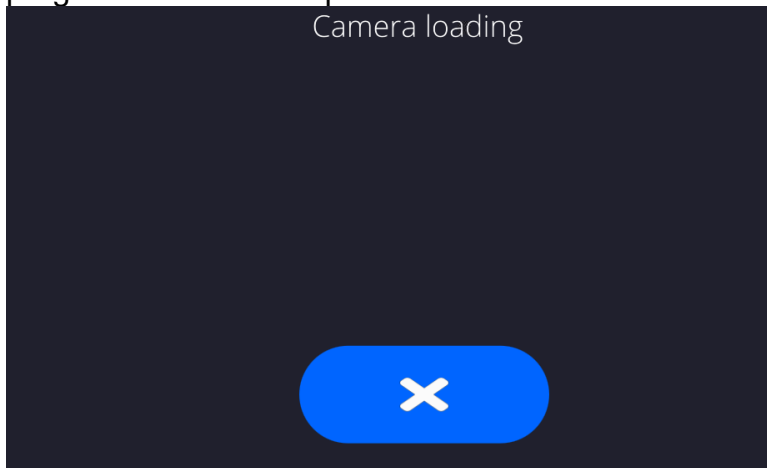

- Once the profile has been saved, a message is displayed along with a picture from the camera.

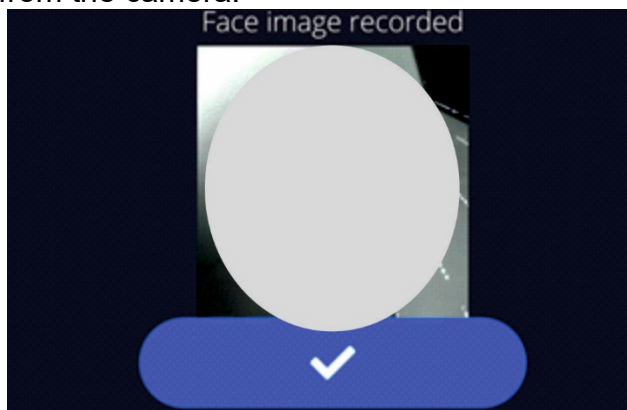

- Press  button to close the window.

- The option description in the user settings changes to <Delete face profile>, indicating that the profile is stored in the balance memory.

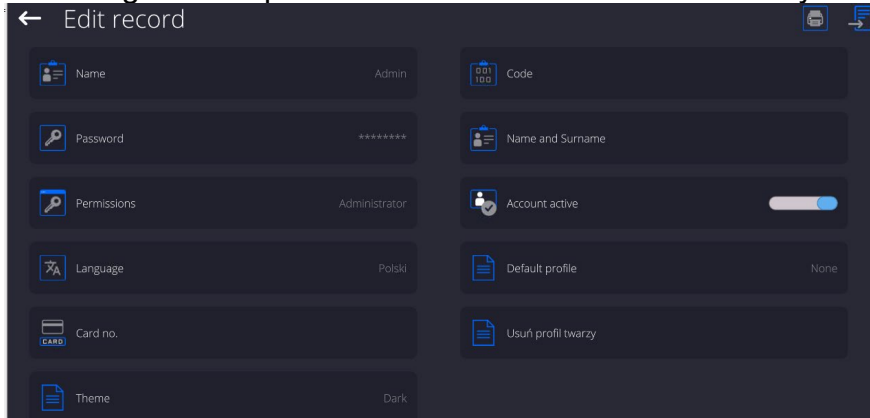

- From now on, if the user for whom the face profile was added logs in, after entering the logging window, the program will automatically read the profile, which will be signalled by the pictogram on the left side of the window

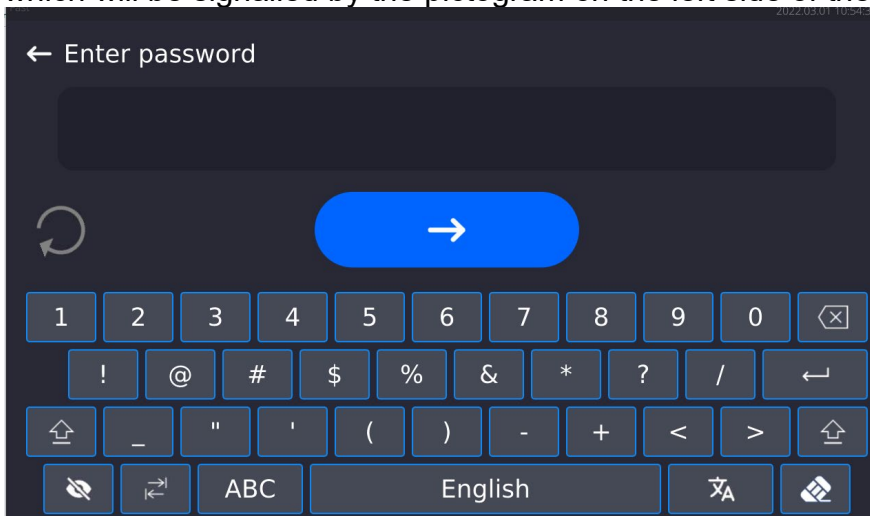

- The program automatically reads a photo of the user's face profile, and after the photo is read, the camera turns on (which is indicated by the lighting of a diode next to the camera) and compares the saved photo with the profile read by the camera. If these images match, the main program window will open and the name of the logged-in user is displayed in the top bar of the window.

Editing data on an operator:

- Press field with operator name.
- Data on a specific operator is displayed.
- Select and change necessary data.

To delete an operator:

- Press and hold operator name.
- Database menu is displayed.
- Select <Delete> parameter and confirm.

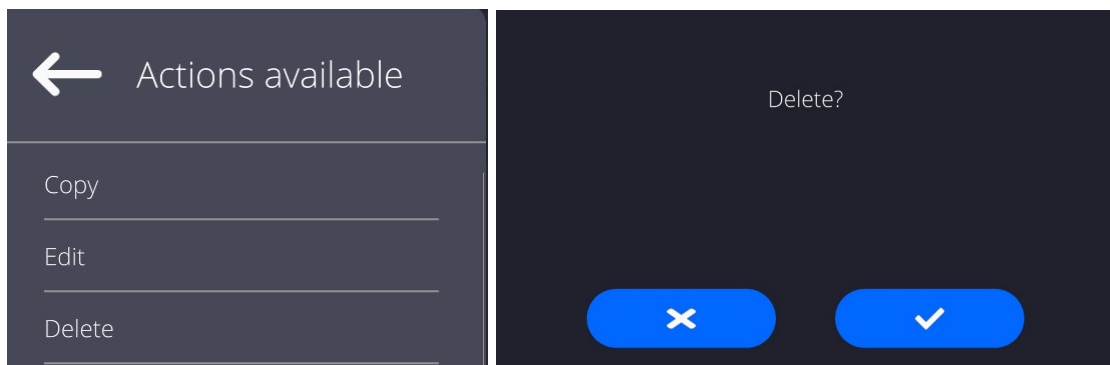

13.3. Products

<Products> database contains names of all products that are weighed, counted or controlled.

Procedure:

- Enter <Databases> submenu, and press < Products> field.
- Press <Add> button to add a new product to the database.
- Select one of available options.

List of parameters defined for a product:

- | | |
|-----------------------------|---|
| 1. Name | [product name] |
| 2. Description | [product description] |
| 3. Code | [product code] |
| 4. EAN code | [product EAN code] |
| 5. Mass | [Unit mass of a product] |
| 6. Min | [Minimal mass for weighing the product using result control thresholds – LO. Value of error <T1-> in working mode <Mass control> determined as percent of the nominal mass] |
| 7. Max | [Maximal mass for weighing the product using result control thresholds – HI. Value of <T1+> error in working mode <Mass control> working mode determined as percent of the nominal mass] |
| 8. Tolerance | [% value calculated in relation to mass (5) denoting measuring area in which the measurement is recognized as correct.] |
| 9. Tare | [Product's tare value, set automatically on selecting a product from the database] |
| 10. Price | [Unit price of a product] |
| 11. Density | [Product's density, used for compensating air buoyancy, as sample density] - [g/cm ³] |
| 12. Shelf-life time in days | |
| 13. Date | [Set product's date (constant)] |
| 14. VAT | [VAT value related to a product] |
| 15. Ingredients | [Editing field for inserting names of ingredients used for preparing a product, e.g. if a product is a mixture, or if a product requires additional description of its features or application] |
| 16. Printout | [Printing a template assigned to a product] |

Caution:

Remember to assign products to respective functions, the values will be automatically adjusted according to the function used while entering the database.

13.4. Customers

Customers database contains name of Customers for whom the measurements are carried out.

Procedure:

- Enter <Databases> submenu and press < Customers> field.
- Press <Add> button.
- If a customer already exists in the database of customers, press field with its name.

List of parameters defined for a customer:

1. Customer name
2. Customer code [internal code identifying a customer]
3. NIP
4. Address
5. Postal code
6. City
7. Discount
8. Printout [type of printout, label declared to a customer]

13.5. Reference Weights

<Reference weights> database contains reference weights used for weights comparison. Reference weights are used when determining Comparison procedure.

Procedure:

- Enter <Databases> submenu and press <Reference weights> field.
- Press <Add> button, should a new reference weight be added.
- If reference weight already exists in the database, press field with its name.

Caution:

It is possible to use the following functions: <Search by name>, <Search by code> <Data export>

List of parameters defined for a reference mass standard::

1. Name
2. Code
3. Class
4. Serial number
5. Mass
6. Set no.

13.6. Test Weights

<Test weights> database contains test weights used for weights comparison. Test weights are used when determining Comparison procedure.

Procedure:

- Enter <Databases> submenu and press <Test weights> field.
- Press <Add> button, should a new test weight be added.
- If test weight already exists in the database, press field with its name.

Caution:

It is possible to use the following functions: <Search by name>, <Search by code> <Data export>

List of parameters defined for a reference mass standard::

1. Name
2. Code

3. Class
4. Mass
5. Order number
6. Test weight number

13.7. Comparison Procedures

<Comparison procedures> database contains determined comparison processes. Comparison procedures are designed to carry out automatic comparison processes. Remember to determine reference weights and test weights.

Procedure:

- Enter <Databases> submenu and press <Comparison procedures> field.
- Press <Add> button, should a new comparison procedure be added.
- If comparison procedure already exists in the database, press field with its name.

Caution:

It is possible to use the following functions: <Search by name>, <Search by code> <Data export>

List of parameters defined for Comparison procedures:

1. Name
2. Code
3. Comparison procedure template (always YES if it is to be remembered)
4. Start delay
5. Start time
6. Clear start time
7. Comparisons

Upon completing information in points 1-6 enter Comparisons file, add new comparison and assign the following features:

1. Reference weight
2. Test weight
3. Cycles quantity
4. Method
5. Start-up weighing cycles quantity
6. Repeat quantity

Next, you can analogously assign next comparison to the same comparison procedure. The quantity of comparison processes in one comparison procedure is determined by the quantity of test and reference weights with which the mass comparator operates.

13.8. Packaging

<Packaging> database contains list of packages for which a name, code and mass value are specified. The tare value is automatically applied when a name of a packaging is selected from the database during weighing process. The tare value is displayed with minus sign.

Procedure:

- Enter <Databases> submenu and press <Packaging> field.
- Press <Add> button, should a new packaging be designed.
- If a packaging record already exists in the database, press field with its name, and insert data on the packaging.

Caution:

It is possible to use an option for searching a record by name or code.

13.9. Warehouses

Depending on the organization of work, the warehouses database contains list of places used for picking up a sample for weighing or list of places to which a weighed sample was delivered. Each warehouse has to have its name, code and description specified. During weighing process, and on selecting name of a warehouse, it is automatically assigned to the measurement result.

Procedure:

- Enter <Databases> submenu and press <Warehouses> field.
- Press <Add> button, should a new warehouse be added.
- If a warehouse record already exists in the database, press field with its name, and insert identifying data.

Caution:

It is possible to use an option for searching a record by name or code.

13.10. Printouts

Printouts database contains all NON-STANDARD printouts. Each printout features a name, code and a template.

Procedure:

- Enter <Databases> submenu and press <Printouts> field.
- Press <Add> button, should a new printout be added.
- If a non-standard printout template already exists in the database, press field with its name, and insert identifying data.

Caution:

It is possible to use an option for searching a record by name or code.

Designing new printout template.

Procedure:

- Enter <Databases> submenu and press <Printouts> field.
- Press <Add> button to create or edit a printout.

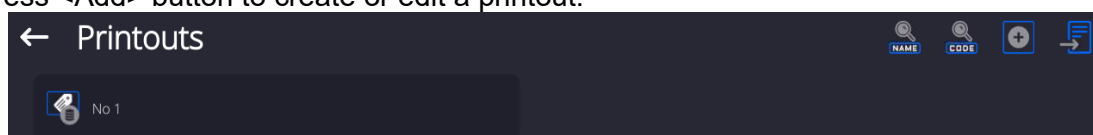

- In <Edit record> field, press <Project> button.
- A window is opened for creating an optional printout.
- Use on-screen keypad to create printout template. It features the same options as a regular computer keyboard.



- Save designed printout.

Example of Printout no. 1 – using large editing field

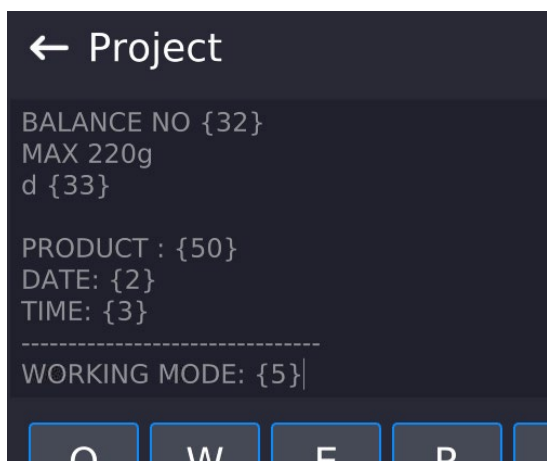

Project

Mass comparator no. 400015
 Mass comparator parameters:
 Max = 220 g
 d= 0.001 g

Product name:
 Date: 2011.10.24
 Time: 11:48:06

 Working mode: Weighing

Net weight: 94.147

Carried out by: Admin

Printout template

Example of Printout no. 2 – printout from a file

All printout templates can be designed in a form of external files, that are imported to a mass comparator. Such file has to have the following extension: *.txt or *.lb and contain all constant and variable data. Upon importing, the content of a printout template can be modified.

Procedure:

- Design a *.txt or *.lb file in an optional editor.
- Copy the file to a USB flash drive.
- Connect the USB flash drive to mass comparator's USB port.
- Press [4] <  Download a printout from a file> button,
- Mass comparator's display shows data stored on the USB flash drive connected to the USB port.
- Search for a file with printout template and press its name.
- The printout template is automatically copied to an editing field.

13.11. Universal Variables

Universal Variables are a set of alphanumeric data which is combined with printouts, products or other information related to comparison. Each variable has to have its name, code and value specified.

Procedure:

- Enter <Databases> submenu and press < Universal variables>.
- Press <Add> button, should a new variable be added.
- If a universal variable already exists in the database, press field with its name, and insert required modifications to the following fields: code, name, value.

Caution:

It is possible to use an option for searching a record by name or code.

13.12. Database Management

Function allowing to manage databases data. It comprises three options: Export weighing database, Delete databases and Delete weighings and reports.



13.12.1. Delete Databases

Function allows you to delete data of selected database. Upon function activation, window for selecting a database data of which is to be deleted is displayed.

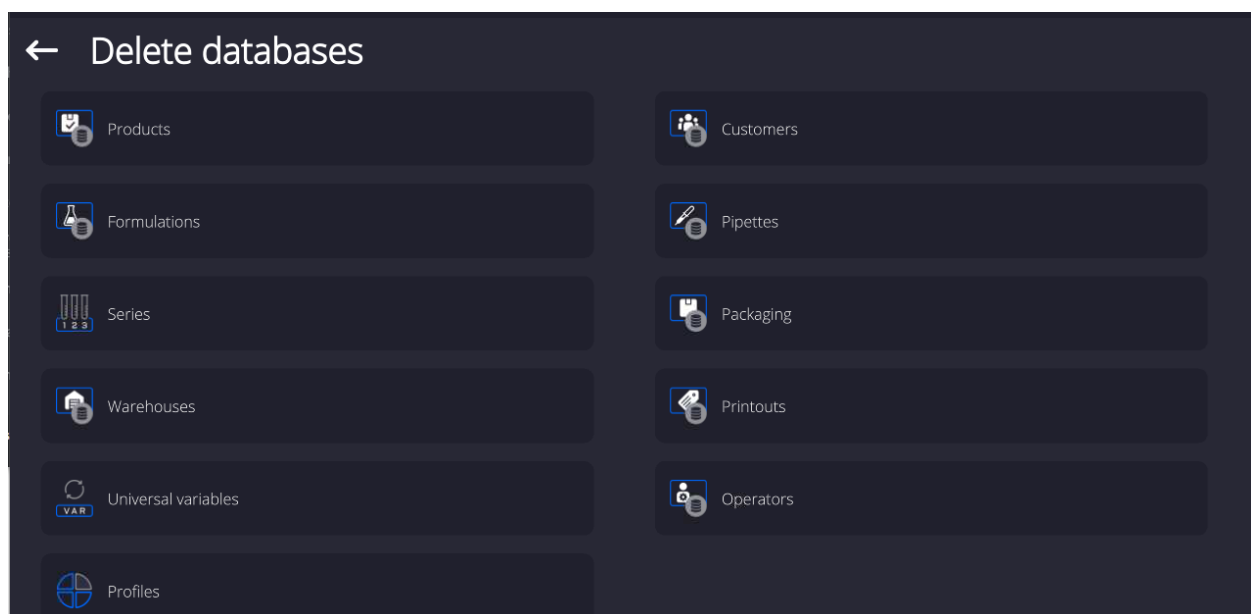

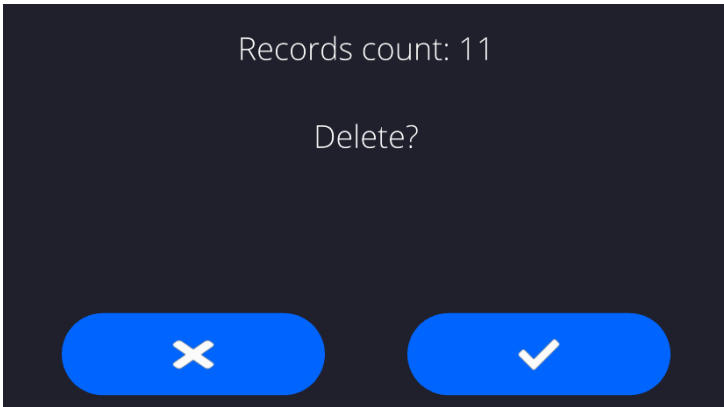

Upon confirmation, data is deleted and the following message is displayed:

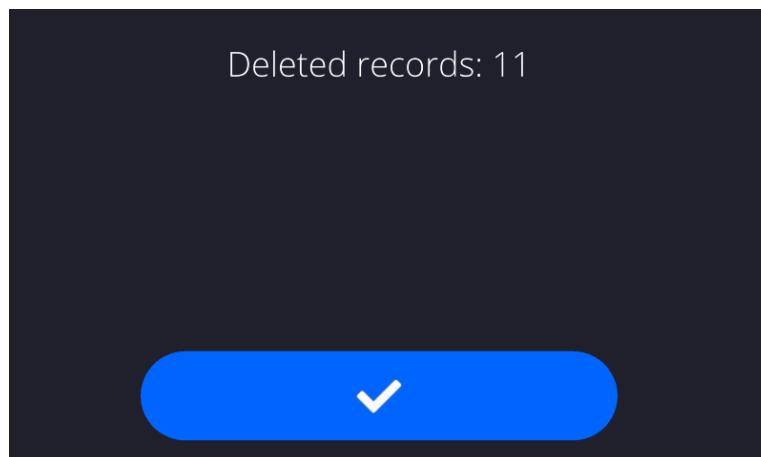

Upon confirmation the software returns to a previous window; you may continue a weighing procedure or proceed to other operations.

14. REPORTS

The balance features the following reports:

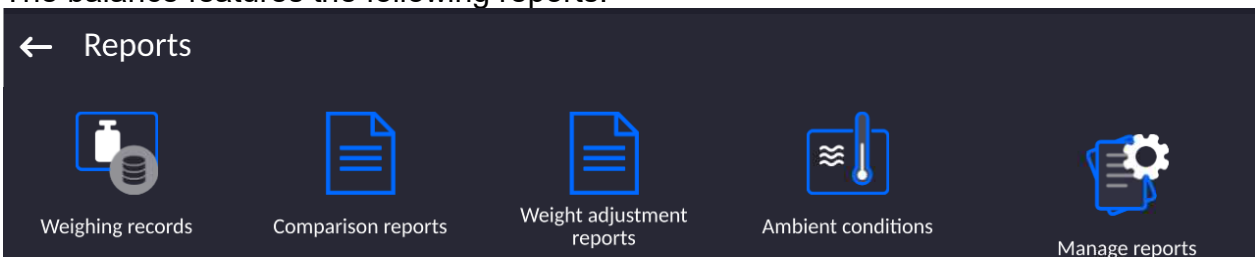

14.1. Reports Operations

Databases can be operated only by an authorized personnel.

Procedure:

- Press and hold a respective database pictogram.
- Database menu is displayed.
- Select one of the available entries (entries set is conditioned by a database).

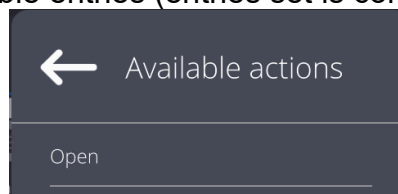

Entries:

- OPEN – select to enter a database (alternative method for database entering: single click on a given database field).

List of typical database operations:

1. Searching for a record in a database by name.
2. Searching for a record in a database by code.
3. Searching for a record in a database by date.
4. Exporting database content to a USB flash drive via USB port.
5. Printing data on a specific record in a database.

The above processes are initiated by dedicated buttons located on the top of the display. Follow the displayed commands.

14.2. Weighings

Each weighing result sent from the weighing device to a printer is saved to the weighings database (read section *Result control*).

You can preview data of particular weighing records.

Procedure:

- Enter < Reports > submenu.
- Enter <Weighings/Alibii> database and select desired record.

List of parameters defined for a weighing record:

1. Measurement date.
2. Measurement result.
3. Tare value.
4. Stable/unstable measurement marking.
5. Air buoyancy control on/off marking.
6. Product name.
7. Operator.
8. Customer, customer name.
9. Working mode name.
10. Warehouse, source warehouse name.
11. Packaging, name of tare applied during product weighing.
12. Result control, information regarding range within which the weighed product is placed:
MIN – below LOW threshold (possible only if <Result control> is set to <NO> value),
OK – between the LOW and HIGH thresholds,
MAX – above HIGH threshold (possible only if <Result control> is set to <NO> value).
13. Weighing platform no., field with number of a weighing instrument by means of which a measurement was carried out.
14. Level status, information on level status maintained during the measurement .
15. Ambient conditions alerts, information regarding stability of temperature and humidity during the measurement.

14.3. Comparison Reports

<Comparison reports> database contains information on carried out comparison processes. Each report can be previewed, searched by date or exported and printed out.

Procedure:

- Enter < Reports > submenu and press <Comparison reports> field.
- Press field of a desired report record.

List of parameters on a comparison report:

1. Order number
2. Start date
3. End date
4. Operator
5. Diameter
6. Standard deviation
7. Cycles quantity
8. Reference weight
9. Test weight number
10. Task
11. Method

14.4. Weight adjustment reports

<Weighing adjustment reports> database contains information on carried out comparison processes. Each report can be previewed, searched by date or exported and printed out.

Procedure:

- Enter <Reports> submenu and press < Weighing adjustment reports > field.
- Press field of a desired report record.

List of parameters on a weighing adjustment reports:

1. Order number
2. Start date
3. End date
4. Operator
5. Diameter
6. Standard deviation
7. Cycles quantity
8. Reference weight
9. Test weight number
10. Task
11. Method

14.5. Ambient Conditions

<Ambient conditions> database contains parameters related to ambient conditions. Depending on the balance type, the ambient conditions report can provide values of temperature, humidity, atmospheric pressure. If the given balance is connected to a THB sensor, then its indications are recorded to the database too.

Procedure:

- Enter < Reports > submenu and press <Ambient conditions> entry.
- Select report, if not visible, scroll using navigation buttons.
- Report is named by date and time.

Caution: *It is possible to use 'search report' option.*

14.6. Databases Management

Function allowing to manage databases data. It comprises three options: Export weighing database, Delete databases and Delete weighings and reports.

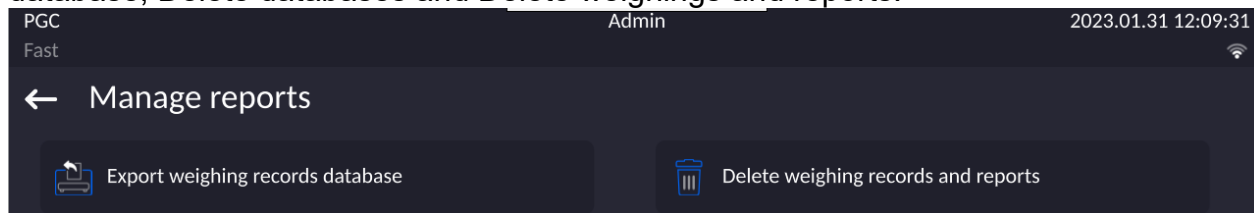

14.6.1. Export Weighing Database to a File

All measurements are saved to the <Weighing records> database and can be exported to a file using a USB flash drive.

Procedure:

- Connect the USB flash drive to the USB port.
- Press <Export weighing records database to a file> entry; a window for setting export options is opened.

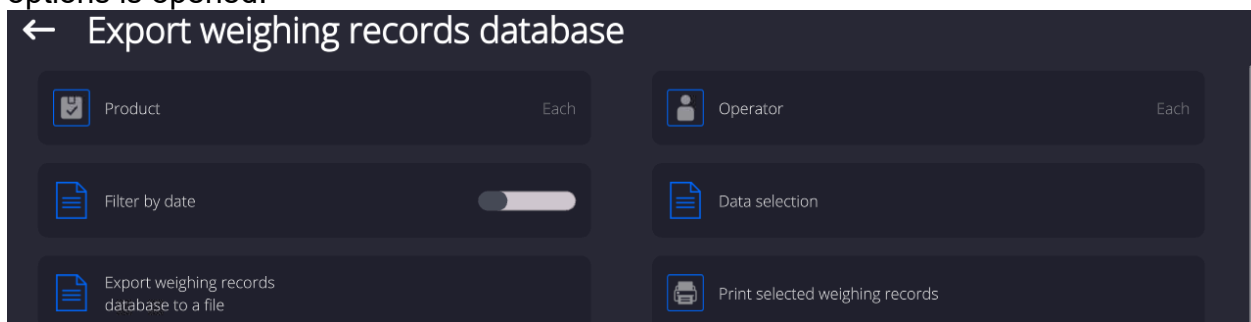

<Data selection> parameter allows you to specify which measurement-related data are to be exported.

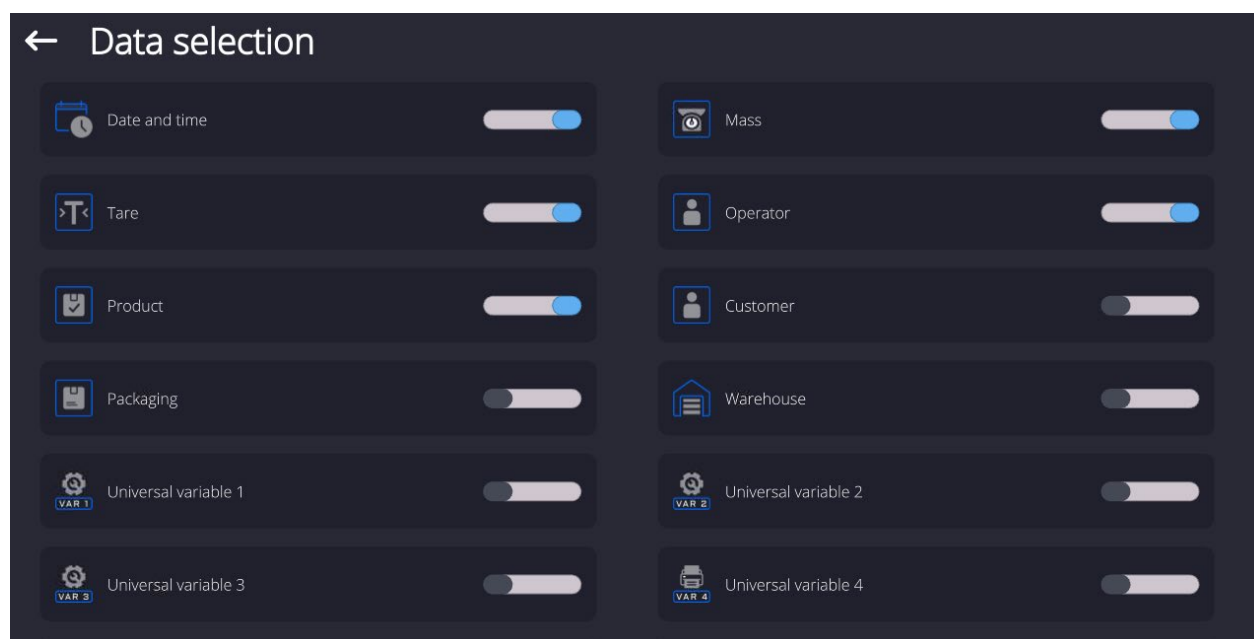

- Set respective data and press <Export weighing records database to a file> entry; weighing database is automatically exported.

- Upon export completion, the message **<Completed>** is displayed along with information on the number of exported data and with the file name (*.txt extension). Next, previous window is displayed.

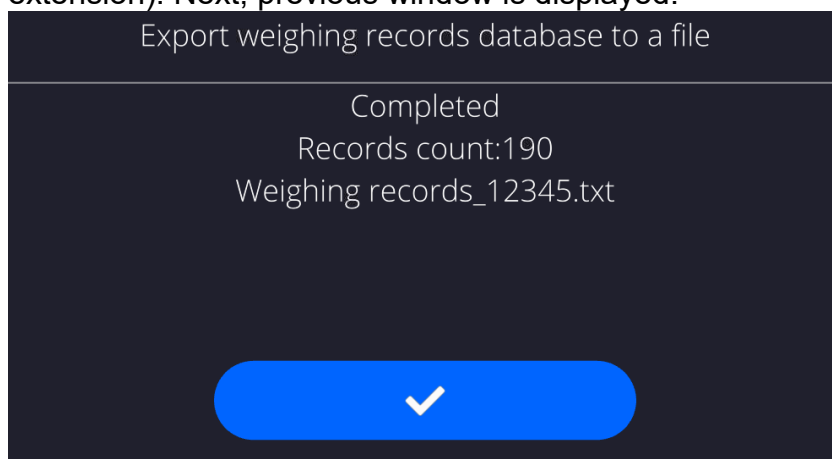

- You may return to the weighing procedure or proceed to other settings.

Caution: *If balance software cannot identify the USB flash drive, then upon pressing <Export weighings database to a file> entry, <Operation failed> message is displayed.*

- A name of created file consists of database name and balance serial number, e.g. <Weighing data_364080.txt>.
- Unplug the USB flash drive from the USB port.

Template of a created file:

The file is created in the form of a table, columns of which are separated by <Tab>. This allows for direct export of the file to <Excel> spreadsheet document. The table contains the following data: date and time, mass and mass unit, tare and tare unit, serial number, operator name, customer name, packaging name, source warehouse name, target warehouse name, control result name.

14.6.2. Delete Weighings and Reports

Function allowing to delete weighings and reports of a given database.

Procedure:

Activate <Delete weighing records and reports> parameter; a window with a numeric keyboard is displayed.

Enter a date specifying which data is to be removed. Date is given in the following form: year-month-day.

← Delete older than

23.12.2021

| grudzień 2021 | | | | | | |
|---------------|-----|-----|------|-----|------|--------|
| pon. | wt. | śr. | czw. | pt. | sob. | niedz. |
| 29 | 30 | 1 | 2 | 3 | 4 | 5 |
| 6 | 7 | 8 | 9 | 10 | 11 | 12 |
| 13 | 14 | 15 | 16 | 17 | 18 | 19 |
| 20 | 21 | 22 | 23 | 24 | 25 | 26 |
| 27 | 28 | 29 | 30 | 31 | 1 | 2 |
| 3 | 4 | 5 | 6 | 7 | 8 | 9 |

→

Confirm the date, all weighings and reports older than those specified by the date are removed. Quantity of deleted weighings and reports is displayed.

15. COMMUNICATION

Communication menu is located in <Parameters> menu. It is accessed by pressing Setup button or <Setup> quick access key. The mass comparator enables communicating with peripheral devices via the following ports:

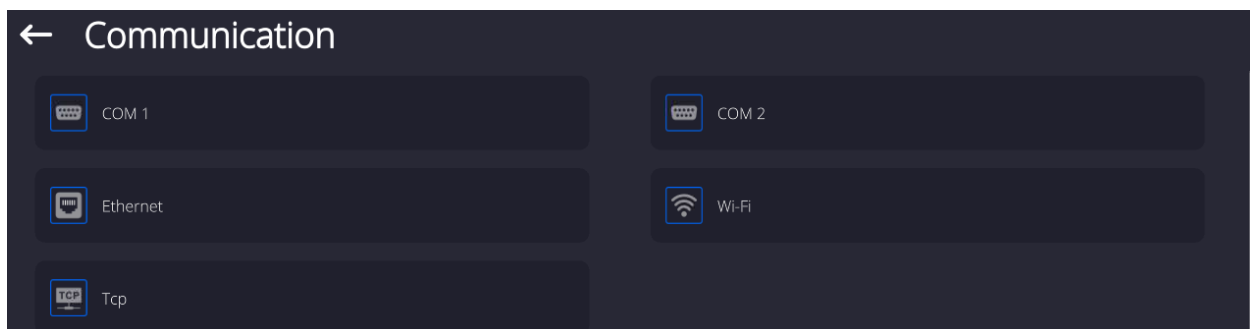

The ports are to be configured depending on the needs.

15.1. RS 232 Settings

CAUTION: to ensure correct communication between the peripherals via RS 232 port, use USB – RS232 converter.

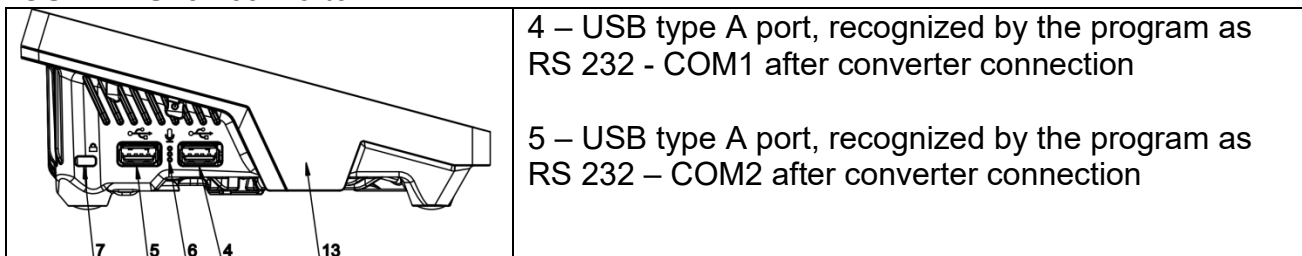

4 – USB type A port, recognized by the program as RS 232 - COM1 after converter connection

5 – USB type A port, recognized by the program as RS 232 – COM2 after converter connection

Procedure:

- Select communication port <COM1> or <COM2>.
- Configure ports.

There are following transmission parameters for RS 232 ports:

- Baud rate: 4800, 9600, 19200, 38400, 57600, 115200 bit/s
- Data bits: 5, 6, 7, 8
- Stop bits: None, 1, 1.5, 2
- Parity: None, Odd, Even, Marker, Interval

15.2. ETHERNET Settings

Procedure:

- Select communication port <Ethernet>. Set appropriate values:
 - DHCP: Yes – No
 - IP Address: 192.168.0.2
 - Subnet mask: 255.255.255.0
 - Default gate: 192.168.0.1

Caution:

Above settings are for information purpose only. Transmission parameters have to be selected in accordance with the settings of customer's local network.

Upon completed modifications, press  button, the following message is displayed: <Restart balance to implement changes>. Return to weighing mode and restart the device.

15.3. Wi-Fi Settings

Mass comparator equipped with Wi-Fi module displays:

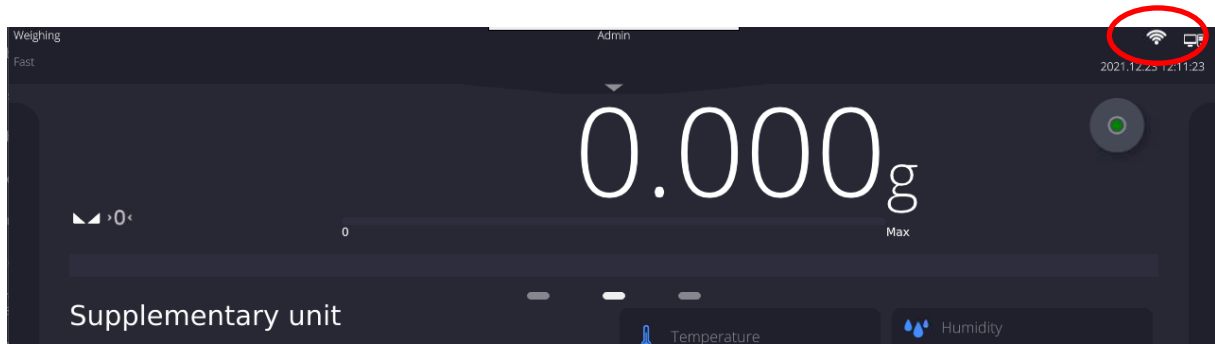

Procedure:

- Select <Wifi> communication interface. Set the following parameters:
 - DHCP: Yes – No
 - IP Address: 10.10.9.155
 - Subnet mask: 255.255.255.0
 - Default gate: 10.10.8.244

Caution:

Above settings are for information purpose only. Transmission parameters have to be selected in accordance with the settings of customer's local network.

Upon completed modifications, press  button, the following message is displayed: <Restart balance to implement changes>. Return to weighing mode and restart the device.

You may use <Available networks> parameter to view the list of networks detected by the balance:

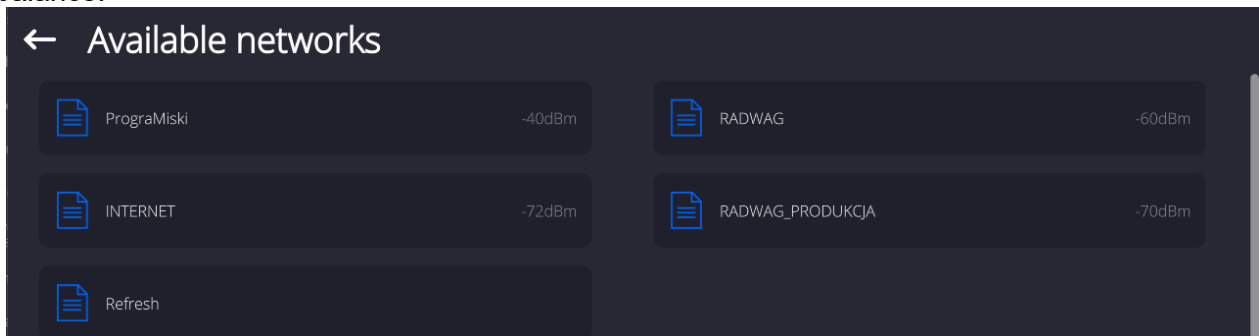

Pictogram with a padlock means that the password is required. Press <Refresh> pictogram to search for available networks.

Press <Network status> field to check selected network parameters. The following parameters are displayed:

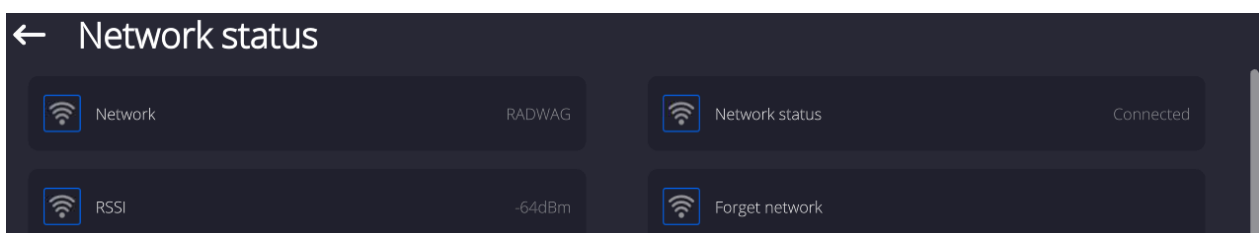

Selected network and parameters for connection are stored in the mass comparator's memory. The software connects to the network using the stored parameters each time the mass comparator is activated. You may change this by selecting <Forget network> which disconnects given network.

16.3.1. Hot Spot

Hot Spot – physical location where Internet access can be obtained, allowing wireless connection with a balance using another device: laptop, tablet, telephone, via wireless network based on Wi-Fi standard. Hot spot owner himself decides with whom and how he intends to share his link by logging in, which requires individual user name and password (data assigned during the hotspot service start-up and stored in the balance memory).

16.3.2. Switching Hot Spot Service On

1. Enter Wi-Fi parameter

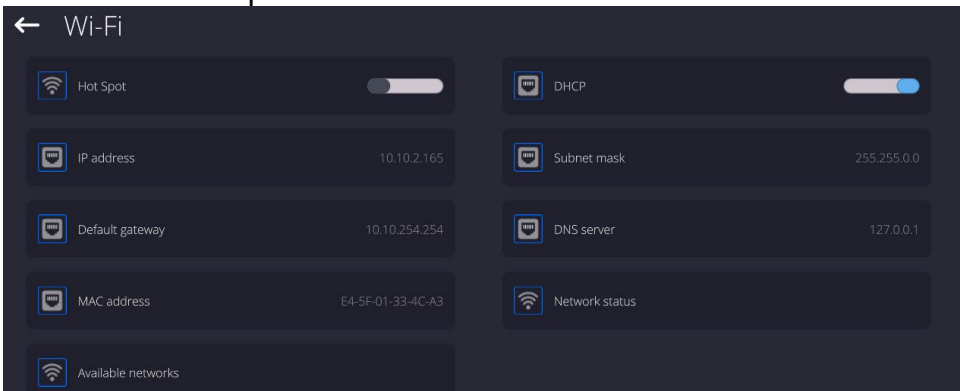

2. Switch Hot Spot on, wait for the service settings to display.

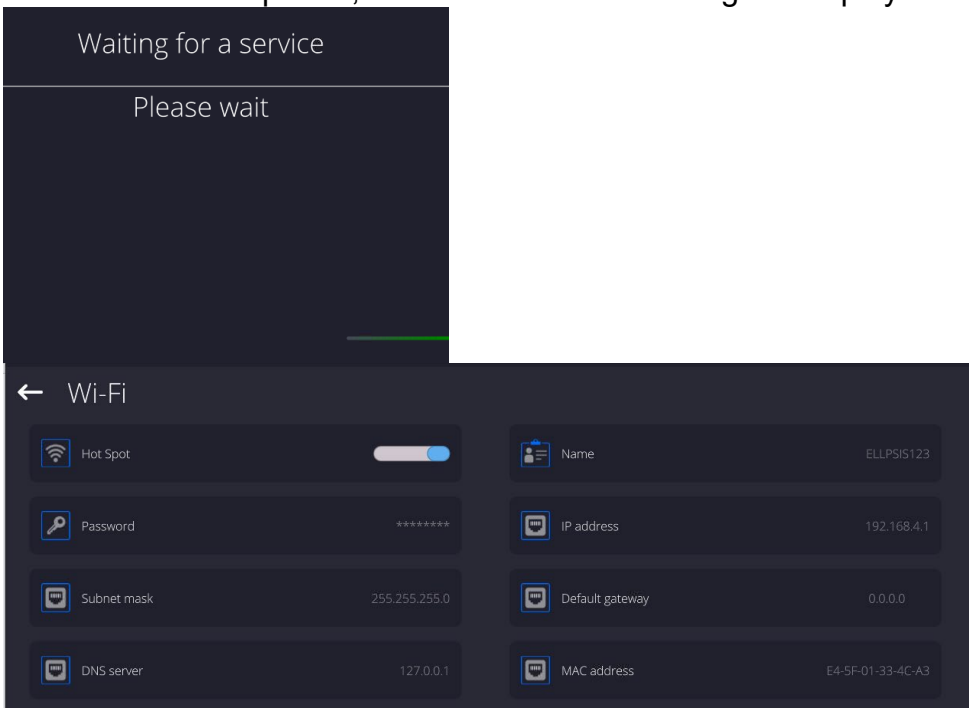

3. Provide user name and password (the password must comprise 8 characters minimum).

← Name

ELLPISIS123

→

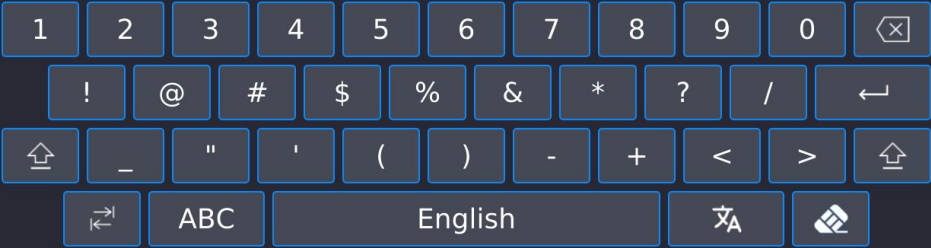

Waiting for a service

Please wait



← New password

→

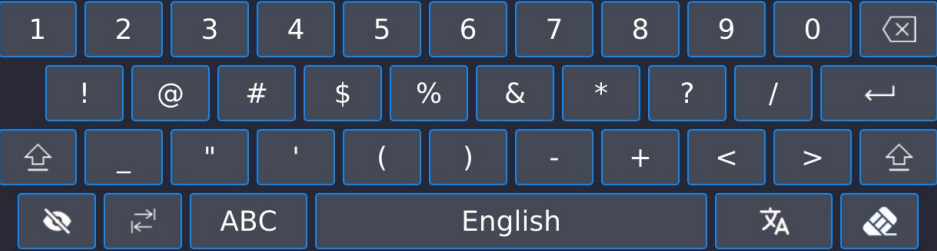

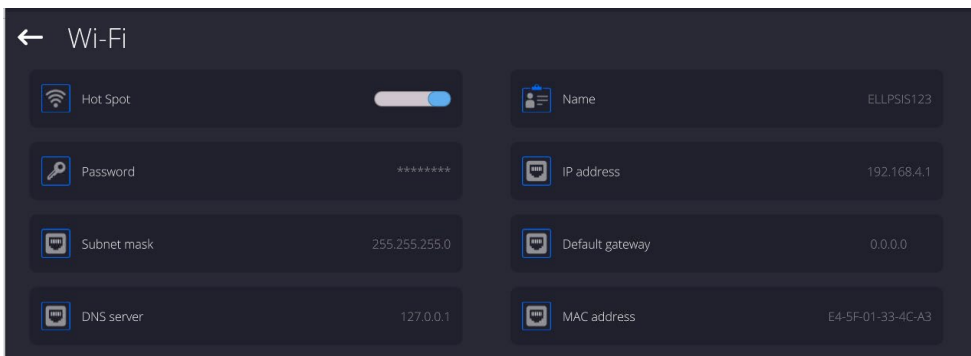
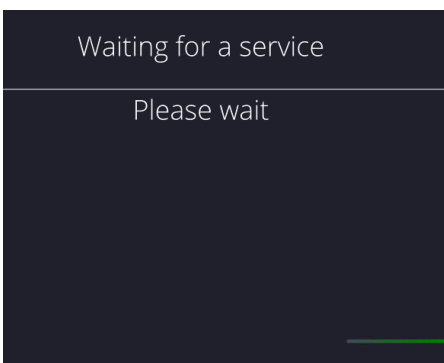
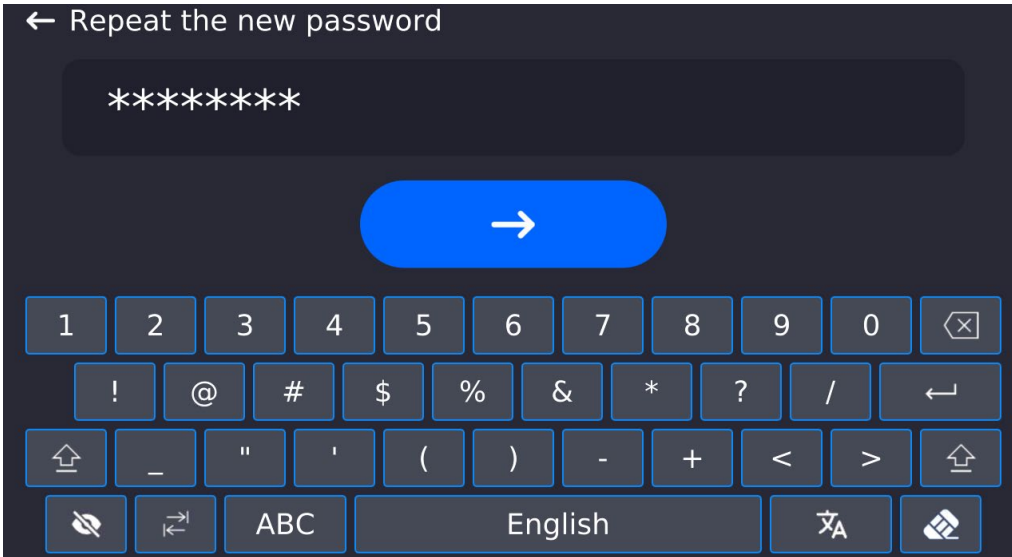

4. From now on, the hot spot service is on, the subnetwork will be detected by other devices such as smartphone under the set name, the user will be able to connect to it with the set password.

15.4. TCP Settings

TCP (*Transmission Control Protocol*) operating in customer-server mode enables communication between two computers. You can establish connection on port specified by server.

Procedure:

- Enter <Communication> parameters.
- Select <Tcp / Port>; a <Port> window with an on-screen keyboard is opened.
- Insert required port number and press  button to confirm.

17. PERIPHERALS

<Peripherals> menu is located in <Parameters> menu. It is accessed by pressing <Setup> key. The menu comprises list of peripheral devices communicating with the mass comparator.

17.1. Computer

 pictogram displayed at the top bar of the home screen signals active connection between a mass comparator and a computer. <Computer> submenu enables configuration of connection settings.

Procedure:

- Press Setup key, next press <Peripherals/ Computer> parameters.
- Set the following parameters:
 - Computer port
available options: none, COM 1, COM 2, Tcp, USB Free Link

USB FREE LINK - USB type C port (port 10 at the back of the housing), to which the computer is connected via USB typeA/typeC cable.

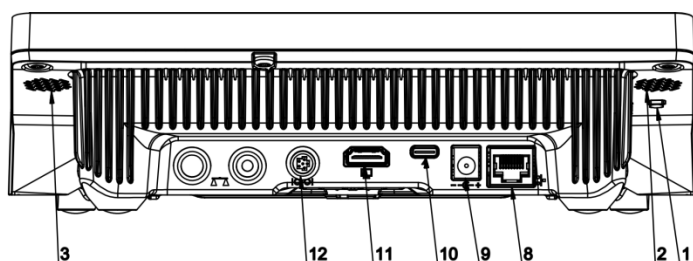

Tool enabling data entering, intended for peripheral devices, operating as a keyboard. With this upon respective modification of standard or non-standard printout, and upon either sending of a respective command from a computer, or pressing ENTER key on a balance keyboard, data contained in non-standard printout are entered directly from the balance to programs such as Excel, Word, Notepad and many other. In order to ensure correct communication with program such as Excel, it is necessary to configure non-standard printout, which must be done by entering format characters, like Tab, Enter or diacritical signs, specific for a particular language, into the designed printout. It must be also remembered to set the correct decimal point (either dot or coma), accepted by our program of Excel type. In order to set the decimal point go to: *Setup/Miscellaneous/Decimal point*.

Example of printout project, and printout printed in Excel:

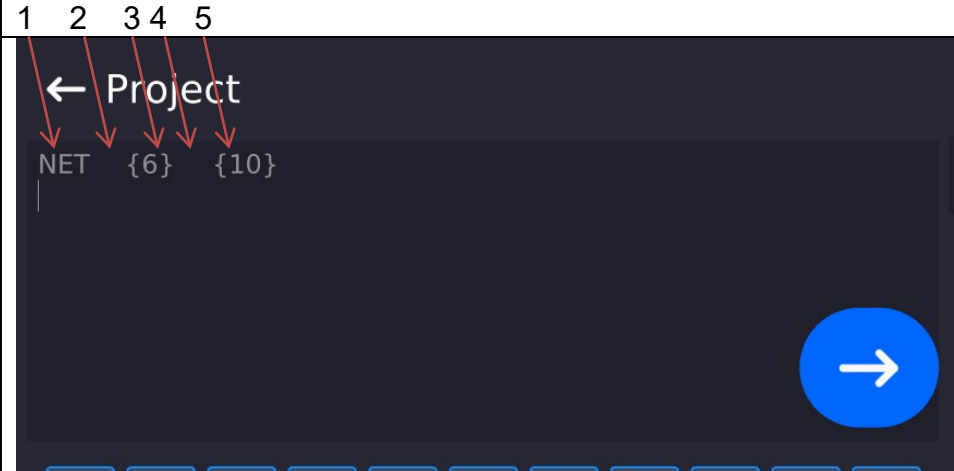
| | |
|--|--|
|  | <p>1 – fixed text 2 – tabulator 3 – variable {6}, net mass in adjustment unit 4 – tabulator 5 – variable {10}, mass unit</p> |
|--|--|

| Y39 | | fx | | | | | |
|-----|---|----|---|--------|----------|---|---|
| | A | B | C | D | E | F | G |
| 1 | | | | | | | |
| 2 | | | | | | | |
| 3 | | | | NETTO: | 1,1235 g | | |
| 4 | | | | NETTO: | 1,1455 g | | |
| 5 | | | | NETTO: | 1,1258 g | | |
| 6 | | | | NETTO: | 1,1325 g | | |

- Address
give address of mass comparator connected to a computer,
- Continuous transmission
available options: NO, YES (*printout format depends on printout template set in a mass comparator– see next parameter*),
- Interval:
Parameter enables setting printout frequency for continuous transmission.
Printout frequency is set in seconds, with 0.1s accuracy.
You can set frequency in a range from 0.1 to 1000 seconds for continuous transmission activated using mass comparator and computer.
- Printout template for weighing
Parameter enables printout customization that is to be carried out in a window with printout template.
- E2R System
E2R System performs supervision and control over all weighing processes carried out using mass comparator. Upon enabling the option, the processes carried out on some of the databases are carried out only from the computer level (mode not available in mass comparator's standard version).

Caution:

<E2R System> can only be activated by mass comparator manufacturer or by authorized personnel. To provide correct cooperation with E2R System continuous transmission has to be activated.

17.2. Printer

<Printer> submenu allows you to:

- set port for establishing communication with a printer,
 - define printer's code page (default: 1250),
 - define control codes for PCL printer or receipt printer.
- Caution: Codes must be entered in a hexadecimal form!**
- define printout templates.



To ensure correct balance – printer operation (correct printout of diacritical signs of a given language), respective baud rate, obligatory for a given printer, must be chosen (see the printer settings). Additionally, the code page of a sent printout must be accordant with the code page of a printer.

There are two methods for obtaining code page accordance:

- by setting the right code page in printer settings (read the printer manual) –
- respective to the printout code page set in the balance;

| Code page | Language |
|-----------|--|
| 1250 | Polish, Czech, Hungarian. |
| 1252 | English, German, Spanish, French, Italian. |
| 1254 | Turkish. |

- by sending a control code from the balance to the printer, which automatically sets the right code page (respective to the code page set in the balance) before the data printout – it is possible only for printers equipped with this option.

| | |
|---|---|
|  | Default value of printer code page is 1250 – central European code page. |
|  | Detailed description of communication between the balance and the labeller is to be found in 'ANNEX 03'. |

USB FREE LINK - USB type C port (socket no. 10 on the back of the indicator), to which the computer is connected using a USB type A/type C cable.

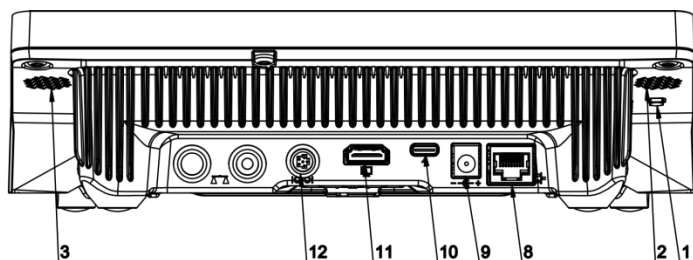

Tool for entering data, it functions as a keyboard. Upon proper modification of the standard or non-standard printout and sending a proper command from the computer, or upon pressing ENTER key located on the operation panel, the data from the non-standard printout are entered directly to computer programs, e.g. Excel, Word, Notepad etc. To ensure proper operation with Excel-type program, the non-standard printout must be properly configured by inserting the print formatting characters, such as Tab, Enter and language-specific diacritics, into the designed printout. Also remember to set the correct decimal separator (full stop or comma) that the Excel-type program will accept. It can be set in: *Setup/Misc./Decimal point*.

Below is an example of a printout template and the resulting printout in Excel:

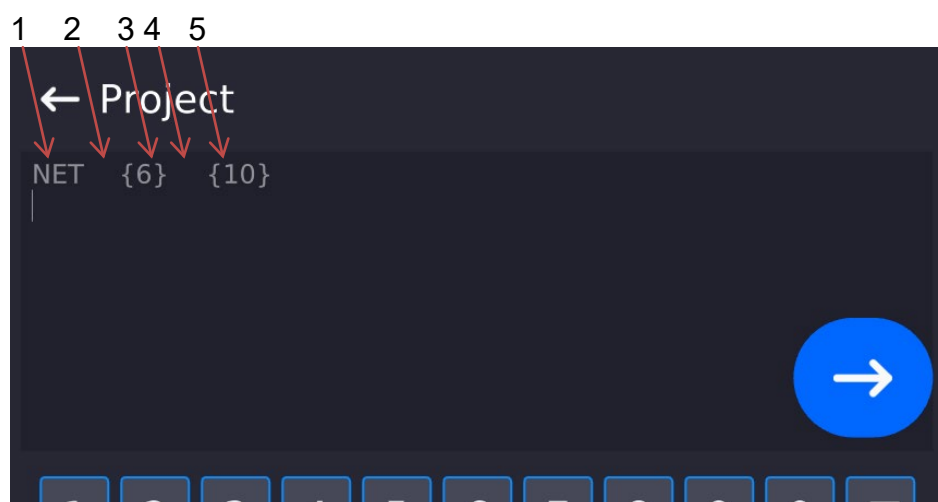

- 1 – fixed text
- 2 – tab key (skip to the next column)
- 3 – variable {6}, net weight in an adjustment unit
- 4 – tab key (skip to the next column)
- 5 – variable {10}, mass unit

| | A | B | C | D | E | F | G |
|---|---|---|---|--------|----------|---|---|
| 1 | | | | | | | |
| 2 | | | | | | | |
| 3 | | | | NETTO: | 1,1235 g | | |
| 4 | | | | NETTO: | 1,1455 g | | |
| 5 | | | | NETTO: | 1,1258 g | | |
| 6 | | | | NETTO: | 1,1325 g | | |

If data with a high information content, such as the SQC report, is to be printed using Free Link, it is imperative that the parameter <Receipt printer speed [character/second]> is set to 15.

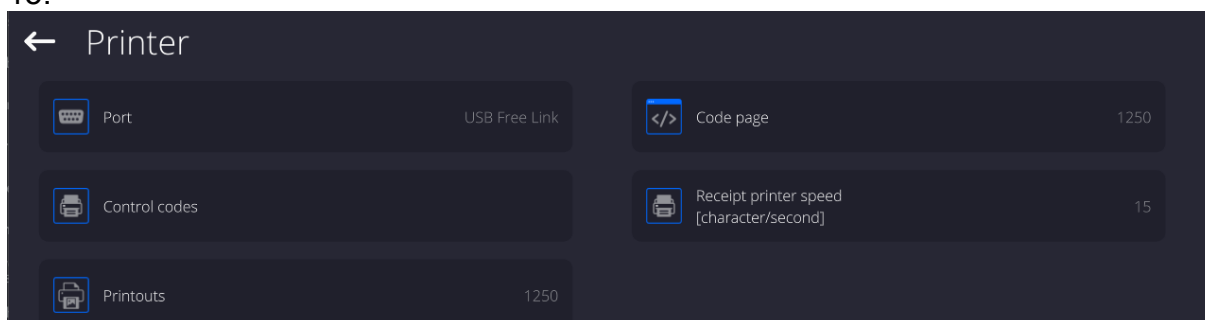

A printout template describes how to print information from databases.

The template can be modified. In order to check the format of a printout template, print the data related to e.g. product parameters. To do it, go to <Products/Edit product> submenu and press printer pictogram.

Default values for particular templates:

Product Printout Template:

{50}

{51}

User Printout Template:

{75}

{76}

Customer Printout Template:

{85}

{86}

Warehouse Printed Template:

{130}

{131}

Packaging Printout Template:

{80}

{81}

{82}

Ambient Condition Printout Template:

{275}

IS T1: {278} °C

IS T2: {279} °C

THB T: {276} °C

THB H: {277} %

Formulation Printout Template:

{165}

Pipette Printout Template: {169}
{310}
{311}

17.3. Barcode Scanner

Mass comparator allows communication with a barcode scanner. The barcode scanner is used to facilitate quick search for database records:

- Products,
- Operators,
- Customers,
- Packaging,
- Warehouses,
- Series in a differential weighing
- Universal variables,

To configure barcode scanner enter:

„**Setup / Peripherals/ Barcode scanner**”.

17.4. Port

Procedure:

- Enter **<Peripherals>** parameter and select „**Barcode scanner / Port**” entry. Select respective option:

Ports:

- USB

17.5. Prefix/Suffix



You can edit **<Prefix>** and **<Suffix>** to synchronize mass comparator’s software with barcode scanner.

Caution:

In RADWAG weighing instruments prefix contains character (byte) presented as 01 hexadecimal, whereas suffix contains character (byte) 0D hexadecimal.

*For detailed description on mass comparator-barcode scanner communication refer to **APPENDIX E** of this user manual.*

Procedure:

- Enter **<Barcode scanner>** submenu,
- Select **<Prefix>** parameter and enter hexadecimal value using on-screen keyboard. Press  button to confirm.
- Select **<Suffix>** parameter and enter hexadecimal value using on-screen keyboard. Press  button to confirm.

17.6. Field Selection

Parameter allowing you to specify, for which field the search is to be carried out in particular databases.

Procedure:

- Enter **<Peripherals>** submenu,
- Select „**Barcode scanner / Field selection**”. List of fields is displayed:

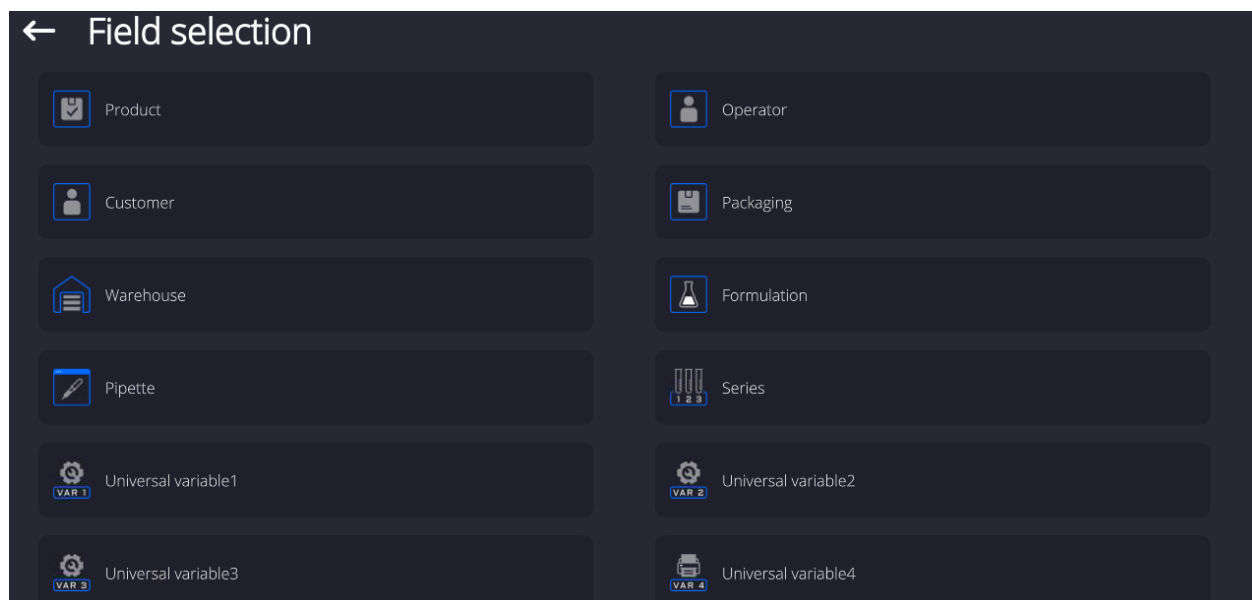

- Select one item from the list. The following parameters may be edited:

| | |
|----------------------|---|
| Filtering | Declaring search criteria (see table below) |
| Offset | Declaring the first significant code's character, characters preceding the first significant character are skipped during comparison search. All preceding sings are omitted. |
| Code length | Declaring the number of code's characters to be taken into account during search procedure. |
| Start marker | Declaring the starting point of scanned code used for searching. |
| End marker | Declaring the ending point of scanned code used for searching. |
| Ignore marker | Determining whether start and end markers are to be used when comparing scanned code with code saved to the mass comparator. |

Filtering criteria conditioned by field type:

| Field selection | Filtering |
|---------------------|----------------------------|
| Product | None, Name, Code, EAN code |
| Operator | None, Name, Code, |
| Customer | None, Name, Code, |
| Packaging | None, Name, Code, |
| Warehouse | None, Name, Code, |
| Formulation | None, Name, Code, |
| Pipette | None, Name, Code, |
| Series | None, Name, Code, |
| Universal variables | None, Active |

17.7. Test

<Test> parameter allowing you to verify if operation of a barcode scanner connected to a mass comparator is correct.

Procedure:

- Enter **<Barcode scanner>** submenu,
- Select **<Test>** parameter; **<Test>** edit box is displayed, it features ASCII and HEX fields.
- The code is scanned and entered to the ASCII field and HEX field, next the test result is displayed in the bottom part.

When:

- **<Prefix>** and **<Suffix>** declared in mass comparator settings comply with **<Prefix>** and **<Suffix>** of the scanned code, the test result is **<Positive>**,
- **<Prefix>** and **<Suffix>** declared in mass comparator settings do NOT comply with **<Prefix>** and **<Suffix>** of the scanned code, the test result is **<Negative>**,

17.8. Ambient Conditions Module

Ambient conditions module (THB) can be connected to the mass comparator via UDP or USB ports. In order to provide correct cooperation select port respective for ambient condition module connection.

18. MISCELLANEOUS

Parameters facilitating mass comparator operation, such as: language, date-time, beep sound, screen calibration, level control. To enter **<Misc.>** submenu, press Setup key, and next press **<Misc.>** button.

18.1. Language

Procedure:

Enter **<Misc.>** submenu.

Select **<Language>** parameter and select language.

Available languages: Polish, English, German, French, Spanish, Korean, Turkish, Chinese, Italian, Czech, Romanian, Hungarian, Russian.

18.2. Date and Time

You can set date, time and their formats.

Date and time setting methods:

- Press **<Date and time>** parameter located on the top of the display (home screen).
- Press **<Setup / Misc./ Date and time>** entry.

Enter date and time settings, an on-screen keyboard is displayed. Set date and time: year, month, day, hour, minute. Confirm.

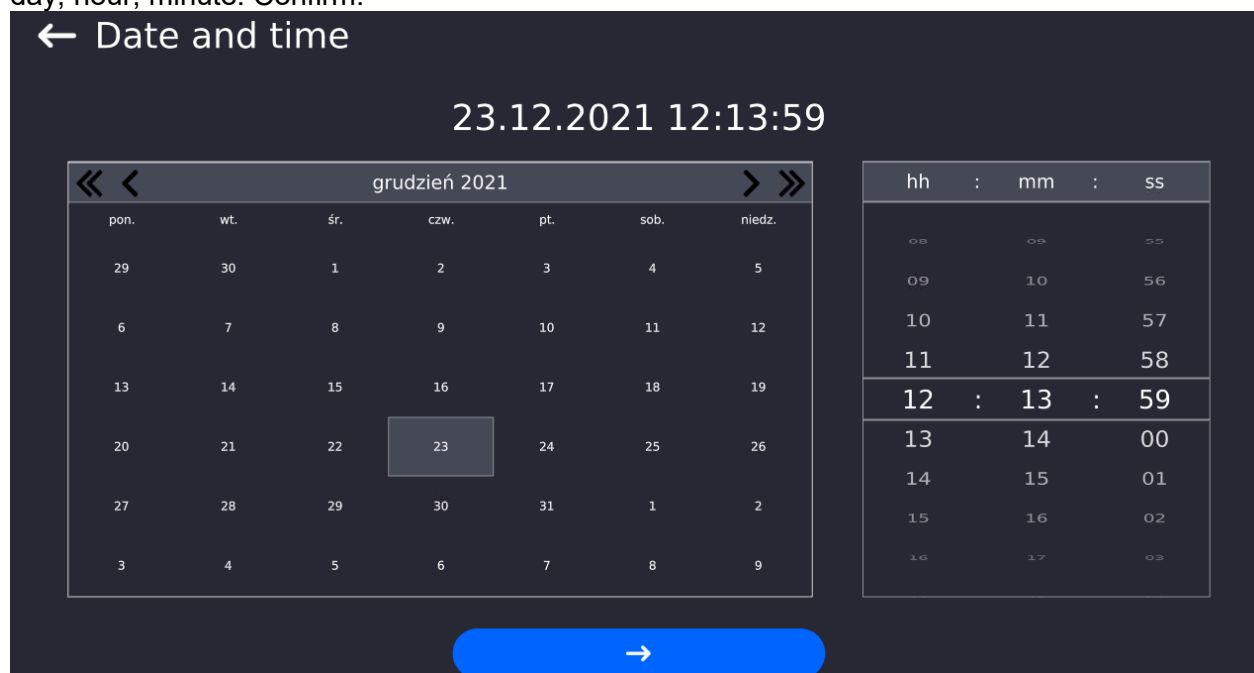

Submenu: <Setup / Misc./ Date and time> contains additional functions for defining date and time format:

| Name | Value | Overview |
|--------------------------------|------------------------|---|
| Time zone | Europe, Warsaw | Parameter value: name of time zone/country, which informs of summer/winter time change. |
| Date and time | 2016.04.04 08:00:00 | Mass comparator's date and time setting |
| Date format | yyyy.MM.dd * | Selecting date format. Available settings: d.M.yy, d/M/yy, d.M.yyyy, dd.MM.yy, dd/MM/yy, dd-MM-yy, dd.MM.yyyy, dd/MM/yyyy, dd-MMM-yy, dd.MMM.yyyy, M/d/yy, M/d/yyyy, MM/dd/yy, MM/dd/yyyy, yy-M-dd, yy/MM/dd, yy-MM-dd, yyyy-M-dd, yyyy.MM.dd, yyyy-MM-dd. |
| Time format | HH:mm:ss ** | Selecting time format. Available settings: H.mm.ss, H:mm:ss, H-mm-ss, HH.mm.ss, HH:mm:ss, HH-mm-ss, H.mm.ss tt, H:mm:ss tt, H-mm-ss tt, HH.mm.ss tt, HH:mm:ss tt, HH-mm-ss tt, h.mm.ss tt, h:mm:ss tt, h-mm-ss tt, hh.mm.ss tt, hh:mm:ss tt, hh-mm-ss tt |
| Hide time | No | Switching on/off date and time in the home screen |
| Time from the Internet | Yes | Possibility of date and time update if the weighing device is connected to the Internet |
| Synchronized with the Internet | Yes | Parameter informing whether the instrument date and time are synchronised with data from the Internet |

*) - For date format: y – year, M – month, d – day

***) - For time format: H – hour, m – minute, s – second

<Date and time> parameter enables previewing declared date and time formats.

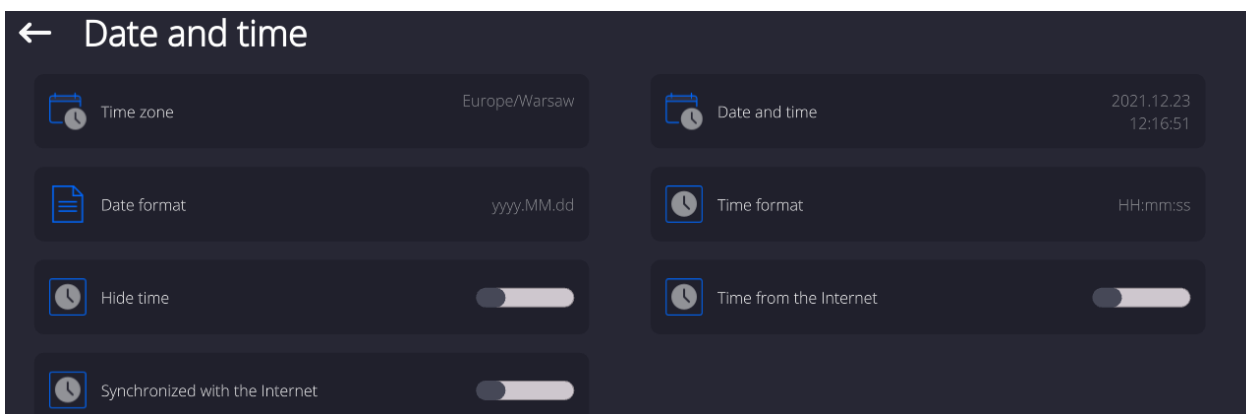

Caution:

<Date and time> parameter can be accessed only by an operator with appropriate permissions. Permissions level can be modified by Administrator in <Permissions> menu.

18.3. Extension Module

Option enabling the user to activate device compliance with FDA 21 CFR procedures, and communication protocol extension, and switching off standard licence (demo version).

Extension module activation requires licence number for particular options, to get the licence number it is necessary to contact the manufacturer.

Procedure:

Enter <Misc.> submenu, select <Extension module> parameter and follow the on=screen prompts.

18.4. Sound

Procedure:

Enter <Misc.> submenu, select <Sound> parameter and set appropriate option:

- Confirmation sound - Yes/No
- Touch panel sound - Yes/No
- Sensors - Yes/No
- Volume - volume range up to 100%

18.5. Display Sleep Mode

You can turn on display sleep mode.

Procedure:

Press Setup key and next go to <Misc./Display sleep mode> submenu.

Select one of the following options: [None; 1; 2; 3; 5; 10; 15]. Digit values stand for a number of minutes. Upon selecting desired value, the software returns to the previous menu.

Caution:

Display turns to sleep mode only when the mass comparator is not operated (the indication on the screen remains the same). Upon mass change, or pressing any key on the panel, the mass comparator returns to weighing.

18.6. Display Brightness

Display brightness influences mass comparator operation time, when the mass comparator is powered with battery. To lengthen the operation, brightness of the display has to be reduced.

Procedure:

Press Setup key and next press: <Misc./Display brightness>.

Enter desired value: [0% - 100%]. Display automatically changes brightness and the software returns to the previous menu.

18.7. Vibration Detection

The program enables detection of incorrect loading of the weighing pan with the sample, incorrect loading may cause greater indication errors. The function is signalled with display of a respective pictogram in mass indication section.



If the incorrect loading is detected, the pictogram turns to red, . This means that the weighing result may be burden with a greater error.

Procedura:

- Enter <Misc.> submenu.
- Select <Vibration detection> option,
- Set:
 - Yes – function enabled
 - No – function disabled

18.8. Level Control

The mass comparator is equipped with Automatic Level Control mechanism.

For non-verified instruments it is possible to define its operation method.

For verified instruments the settings are inactive, operation proceeds in accordance with default settings, i.e. <Active with lock>, weighing is possible only when the device is levelled.

Procedure:

- Enter <Misc.> submenu.
- Select <Level control> parameter, an edit box is displayed.
- Select one of available options:
 - None – level indicator is not displayed, the mass comparator does not control level status,
 - Active – level indicator is displayed, the mass comparator alerts level change by changing colour of level indicator (green→ level status OK, red→ level status lost),
 - Active with lock – level indicator is displayed, the mass comparator alerts level change by changing colour of level indicator (green→ level status OK, red → level status lost). If level indicator is red, the display also shows an alert – no Level - , and blocks weighing function until level status is restored.

Caution:

For detailed information on mass comparator levelling refer to section 9.3 of this user manual.

18.9. Decimal Point

Parameter enabling selection of decimal point type for the mass printout.

Procedure:

- Enter <Misc.> submenu.
- Select <Decimal point> parameter, an edit box is displayed.
- Select one of available options:
 - Dot
 - Coma
- Decimal point submenu is displayed

18,10, Proximity Sensors Sensitivity

The parameter is adjustable between 0 – 9, and it determines the distance from which the IR proximity sensors react.

As standard, the sensitivity is set within the range of 5 to 7.

Procedure:

- Enter <Misc.> submenu.
- Select <Proximity sensors sensitivity> parameter, an edit box is displayed.
- Select one of available options. The selection causes immediate returning to the menu window.

18.11. Doorway Degree

Parameter for setting how wide the door is to be opened at automatic operation.
Default value: <100 %> - maximally open door.

Procedure:

- Enter <Misc.> submenu.
- Select <Doorway degree> parameter, an edit box is displayed.
- Select the requested value, e.g. <75%>.
- Confirm. The software returns to menu window.

18.12. Automatic Ionisation

Parameter allowing either to switch the ionisation on or to set its rate.
Values: None/Low/High/Continuous operation.

Procedure:

- Enter <Misc.> submenu.
- Select <Automatic ionisation> parameter, an edit box is displayed.
- Select the requested value, e.g. <Low>.
- Confirm. The software returns to menu window.

18.13. Autotest

<AUTOTEST> function is designed to aid you in both assessing mass comparator's operation and diagnosing the reasons for occurrence of errors in weighing which exceed the maximum permissible values for a given mass comparator model.

By means of a simple, repeatable and fully documented way the function enables optimizing mass comparator's settings to maintain the best possible repeatability and weighing time at a workstation. The main purpose of function operation is the possibility of monitoring the above mentioned parameters at optional moment and saving records from carried out tests.

The functions is divided into two modules:
AUTOTEST FILTER; AUTOTEST GLP.

Before testing the mass comparator controls its level status, temperature and humidity.

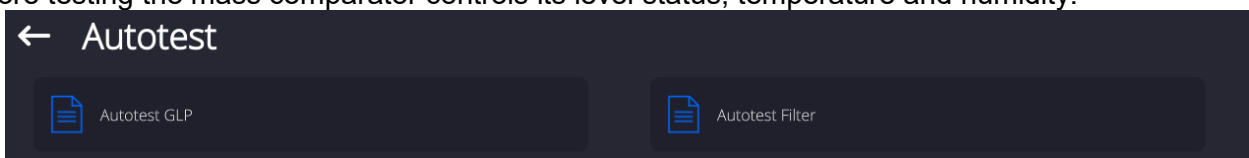

AUTOTEST FILTER

It is a process of 10 times loading and unloading of the internal weight for all possible settings of mass comparator's filter and value release. The test controls 2 parameters: Repeatability and stabilization time of measurement result.

The whole testing process takes approximately 1 hour. Upon completing the test for all possible settings, mass comparator displays a message with obtained results.

You are given information on optimum mass comparator settings in present ambient conditions.

The function provides data on the best possible mass comparator settings for obtaining the highest measurement repeatability and the shortest measurement time with acceptable value of repeatability.

Test results are stored in mass comparator memory until the mass comparator is turned off.

Additionally the function enables:

- Printing test results
- Selecting optimum parameters from the mass comparator's option level.

Upon completed autotest, a summary with results is displayed. The software automatically informs on filter settings by means of respective pictograms displayed next to the results:

- settings providing the fastest measurement (the shortest time interval for measurement performance).
- settings providing the most accurate measurement (the lowest possible value of deviation for 10 measurements).
- settings providing optimal measurement (the lowest value of time and deviation product).

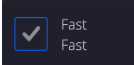

- current settings for filters.

Measurement results:

- *Filter type.
- *Setting of <Value release> parameter.
- *Repeatability of indications expressed as standard deviation.
- *Average time of measurement stabilization.

Example:

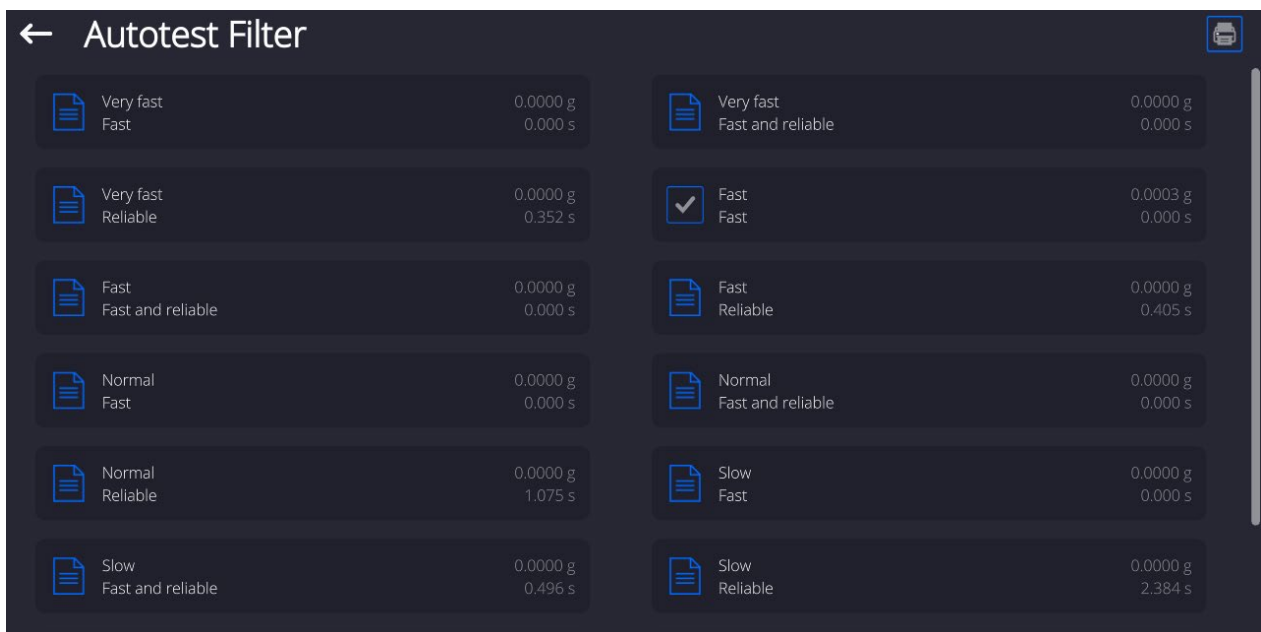

Report template:

```

----- Autotest Filter: Report -----
Mass comparator type   AK/100 5Y
Mass comparator S/N   442566
Operator              Hubert
Software ver.         NL1.6.5 S
Date                  2015.05.07
Time                  09:34:48

-----
Reading unit          0.0001/0.0001 g
Internal weight mass  148.9390 g
Temperature: Start    25.26 °C
Temperature: Stop     25.66 °C

-----
Filter                Very fast
Value release         Fast
Repeatability         0.0042 g
Stabilization time    4.505 s
    
```

Filter *Very slow*
Value release *Reliable*
Repeatability *0.0207 g*
Stabilization time *5.015 s*

Signature

Procedure:

Upon function activation, the process starts automatically. Progress of the process is displayed. Upon process completion, a summary is displayed, current filter settings are shown. The report can be printed.

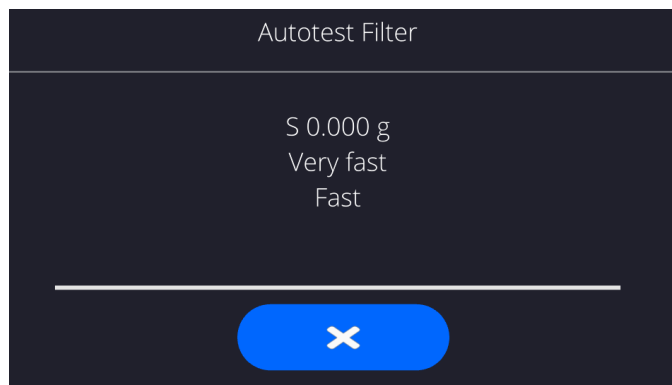

You can abort the process at any moment. To do that press <X> button.

AUTOTEST GLP

The test controls repeatability of loading the internal weight and determining error of indication with reference to mass comparator's maximum capacity.

Procedure:

- Two times loading of the internal weight, followed by 10 times loading of the internal weight.
- Mass comparator internal adjustment.
- Calculating and recording the value of standard deviation.
- In mass comparators with automatically opened doors, door opening and closing test is carried out.

Additionally the function enables: displaying and printing a report on available printers and saving the report in mass comparator's memory. The report contains basic data on mass comparator's parameters, ambient conditions and test results.

Test results:

- *Deviation for maximum capacity.
- *Value of repeatability expressed as standard deviation.
- *Result of door test (positive / negative) – if a mass comparator features automatic door opening system.

Report template:

```
.....  
----- Autotest GLP: Report -----  
Mass comparator type    XA 5Y  
Mass comparator S/N    400010  
Operator    Admin  
Software ver.    L0.0.21 S  
Date    2012.01.16  
Time    09:17:16  
-----  
Measurements quantity    10  
Reading unit    0.0001 g  
Internal weight mass 140.094 g
```

Filter Average
Value release Fast & reliable

Deviation for Max. -0.0118 g
Repeatability 0.00088 g
Signature

Procedure:

Upon pressing a field with test name, the mass comparator displays a message box. Here, you can:

- Start subsequent AUTOTEST GLP process,
- Preview results of completed autotests, and export all saved test results as file with *.csv extension,
- Delete all saved test results.

You can abort the process at any moment by pressing <X> button.

Results of carried out autotests are displayed as a table (each line features date and time of autotest procedure and its result).

To preview detailed data of an autotest, press a specified line of the table with test results.

In order to print a result of a single autotest, enter its details (see above) and generate a printout by pressing <Print> key located on the top of the display.

Autotest results can be exported by pressing <Export> field in the window with all saved reports. Data is sent to a USB flash drive connected to mass comparator's USB port as a file with *.csv extension.

18.14. Start-Up Logo

(option enabled only for authorized mass comparator operators)

The parameter enables changing a logo that appears on the mass comparator's display on a start-up procedure.

18.15. Export of System Events

(option enabled only for authorized mass comparator operators)

The parameter enables generating a special type of a file that is automatically saved upon enabling an option on a USB flash drive connected to mass comparator's USB port. The file is used by RADWAG service for diagnosing any potential problems that occur during mass comparator operation.

Procedure:

- Plug a USB flash drive to mass comparator's USB port.
- Enter <Misc.> submenu.
- Select <Export system events> parameter.
- The software generates a file and automatically saves it on the USB flash drive.
- The generated file has to be sent to RADWAG.

18.16. Text-to-Speech Conversion

The parameter enables conversion of names of particular menu groups and parameters to speech, emitted from the speakers of the operation panel.

19.SCHEDULED TASKS

'Scheduled tasks' menu features settings allowing to plan repetition of tasks such as adjustment or display of particular message in a cyclic manner.

19.1. Adjustment

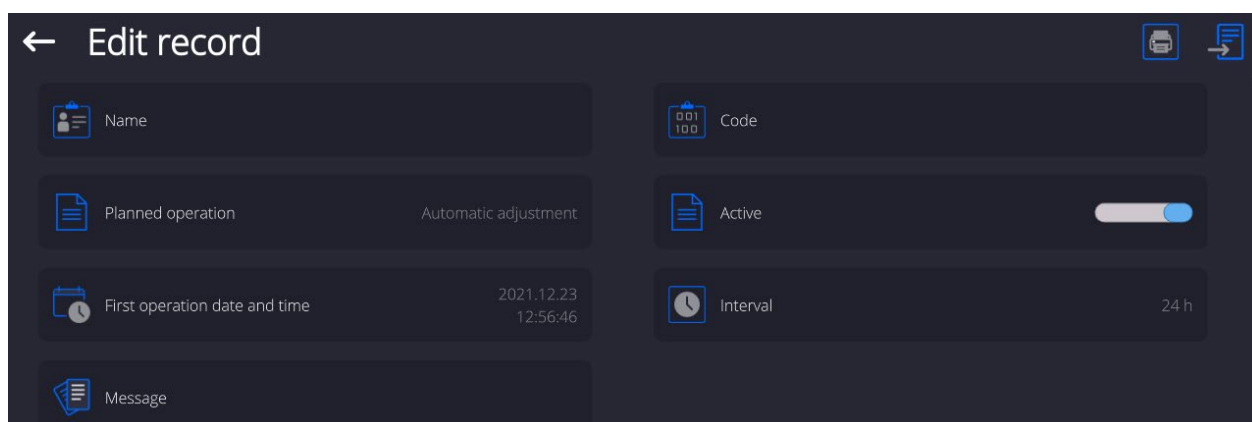



<Scheduled adjustment> parameter enables user to declare exact time and interval of adjustment performance. This function operates independently from an automatic adjustment and its triggering criteria (time, temperature). The user may plan either an internal or external adjustment. In order to plan external adjustments enter mass standards, using which the adjustment is to be performed, to the device memory.

Settings:

Prior to setting the adjustment plan, enter mass standards data, using which the adjustment is to be performed, to the device memory.

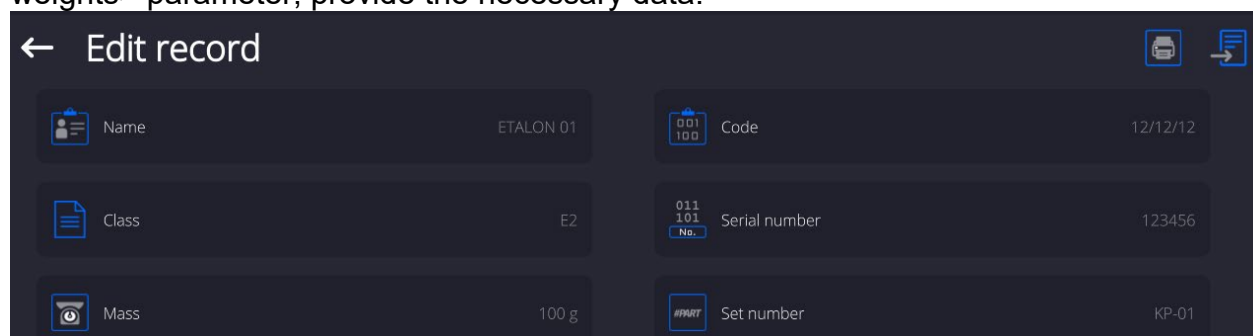
To do it go to the user menu, enter <Adjustment> parameter group and find <Adjustment weights> parameter, provide the necessary data:



| | |
|--|--|
| | <p>Go to the user menu, enter <Scheduled tasks> entry. Respective window opens where Administrator may add new records.</p> |
| | <p>To add new record press  key, window with data of planned adjustments opens.</p> |
| | <p>Select scheduled task entry: automatic adjustment (internal) or external.</p> |

| | |
|--|--|
| <p>← Edit record</p> <p>Name: test 01 Code: 12345</p> <p>Planned operation: Automatic adjustment Active: <input checked="" type="checkbox"/></p> <p>First operation date and time: 2021.12.23 12:59:25 Interval: 24 h</p> <p>Message</p> | <p>In the case of automatic adjustment, provide data on the adjustment and its schedule.</p> |
| <p>← Edit record</p> <p>Name: test 01 Code: 12345</p> <p>Planned operation: External adjustment Adjustment weight: ETALON 01</p> <p>Active: <input checked="" type="checkbox"/> First operation date and time: 2021.12.23 12:59:25</p> <p>Interval: 24 h Message</p> | <p>In the case of external adjustment, provide data on the adjustment, the mass standard using which the adjustment is to be done, and the schedule.</p> |
| <p>← Scheduled tasks</p> <p>test 01</p> | <p>Go back, new record is added.</p> |





Leave the menu.

Now the adjustments will be carried out automatically: in accordance with the set time and interval.

19.2. Message

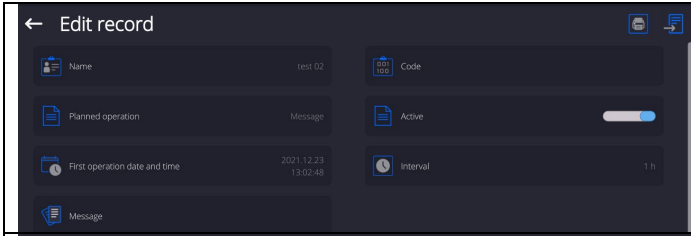
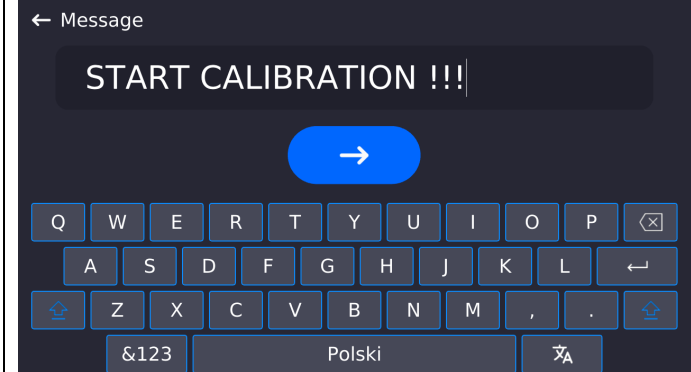
Parameter enabling the user to declare exact time and interval for display of a specific message informing the user about the necessity to take up a particular action

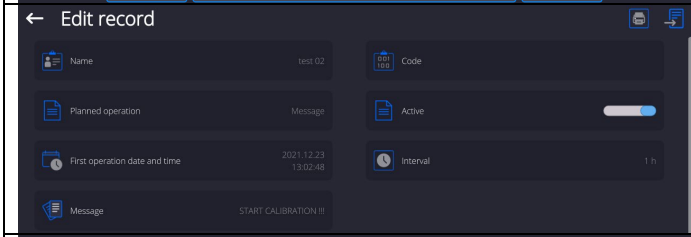
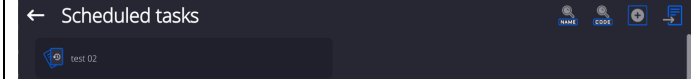
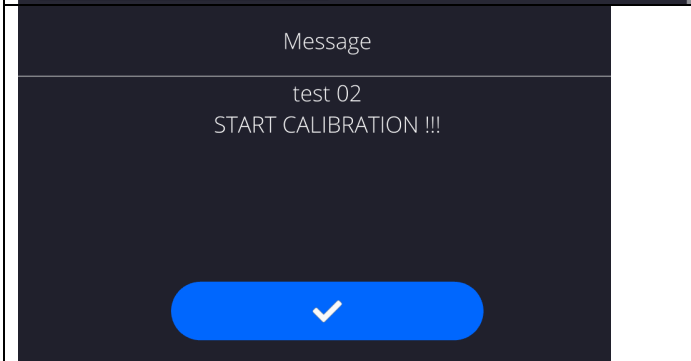
| | |
|---|--|
| <p>← Scheduled tasks</p> | <p>Go to the user menu, enter <Scheduled tasks> entry.</p> <p>To add new task press  key.</p> |
| <p>← Edit record</p> <p>Name: test 01 Code: 12345</p> <p>Planned operation: Automatic adjustment Active: <input checked="" type="checkbox"/></p> <p>First operation date and time: 2021.12.23 12:59:25 Interval: 24 h</p> <p>Message</p> | <p>Respective window opens, select <Scheduled tasks> entry.</p> |
| <p>← Planned operation</p> <p>Automatic adjustment</p> <p>Message</p> <p>External adjustment</p> | <p>Select <Message> option.</p> |

| | |
|---|---|
|  | <p>Message settings window opens. Set message display frequency (first operation date and time, interval) and provide message text to be displayed.</p> |
|  | <p>Confirm by pressing <  > key.</p> |
|  | <p>Previously displayed window opens.</p> |
|  | <p>Submenu window features planned task field. Go to the home screen.</p> |
|  | <p>With the message display criteria met (time), the message is displayed automatically. Press <  > key, the window closes, carry out the planned task.</p> |

20. AMBIENT CONDITIONS

Mass comparators are equipped with ambient conditions sensors, which record ambient conditions of the mass comparator's inside, and optionally with an external THB module which records ambient conditions outside the mass comparator:

- Internal sensor: Temperature 1
- Internal sensor: Temperature 2
- Internal sensor: Humidity
- *External sensor: THB ambient conditions module

*External sensor is provided on a customer request.

You can modify the following parameters in <Ambient conditions> submenu:

- Ambient conditions recording interval
- Ambient conditions module

Procedure

Enter <Parameters> menu.

Select <Ambient conditions> parameter.

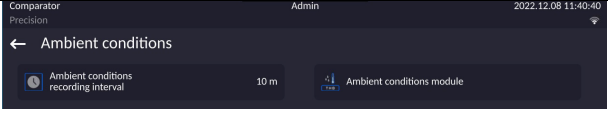
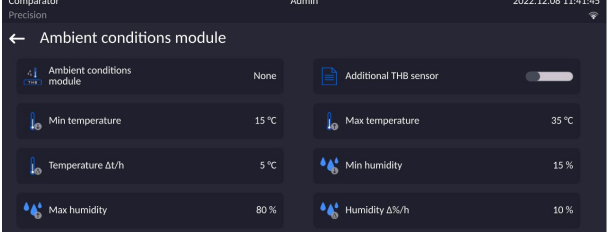
| | |
|---|--|
| <p>Enter <Ambient conditions recording interval> parameter and specify the intervals for ambient conditions records. You can view the history of ambient conditions records. All ambient conditions records are to be found in <Database> in <Ambient conditions> database.</p> |  |
| <p>Enter <Ambient conditions> menu and determine ambient conditions parameters. Thermo-hygro-barometer (THB) <Ambient conditions module> is a module that records 3 types of ambient conditions:</p> <ul style="list-style-type: none"> • Temperature • Humidity |  |

Caution:

Ambient conditions determined by the operator cannot exceed the limits specified in ambient conditions module Technical Specifications. If ambient conditions are different than those specified in the Technical Specifications, the mass comparator may not operate as intended.



21. UPDATE

The function enables updating:

- Area of an operator: APPLICATION.
- Metrological parameters: main board (only administrator).

Updating process takes place automatically by loading data from a USB flash drive connected to mass comparator's USB port.

Procedure:

- Prepare a USB flash drive with update file. Required file extension: **.lab4*.
- Connect the USB flash drive to mass comparator's USB port.
- Log in as an Administrator
- Enter the balance menu, to do it press  key
- Select <Update> option, .
- Select <Application> entry.
- The content of the USB flash drive is displayed, search for the update file, click the file.
- Balance restart proceeds, application update takes place automatically.
- Shall the restart fail, turn the balance off and on.

The process of updating the main board files takes places analogously to the above described procedure, but the required extension of the update file is: **.cm4mbu*.

22. ABOUT

This menu contains data on mass comparator specification and installed applications. Most of parameters in this menu are for the information purpose only.

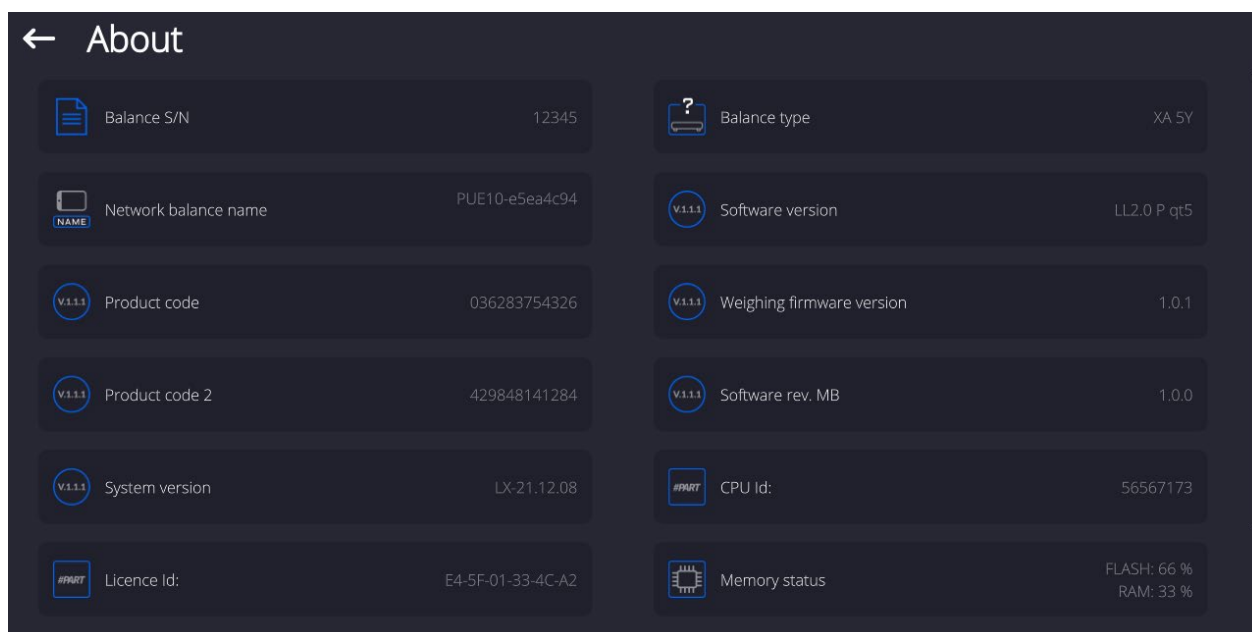

<Ambient conditions> parameter enables previewing present ambient conditions: temperature, humidity, pressure (if a mass comparator features corresponding ambient conditions sensors). Upon selecting <Print settings> parameter, the mass comparator sends all settings to a printer.

23. COMMUNICATION PROTOCOL



Detailed description of protocol of communication between the balance and the computer is to be found in 'CBCP-07' manual.

23.1. Manual Printout/Automatic Printout

The mass comparator enables generating manual and automatic printouts.

- Manual printout: upon indication stabilization press  key.
- Automatic printout is generated automatically in accordance with the settings for automatic printout (read section 14.5 of this user manual).

The content of printout depends on settings of <Standard printout> - <Weighing printout template> menu (read: section 14.5 of this user manual).

Mass printout format:

| 1 | 2 | 3 | 4 -12 | 13 | 14 | 15 | 16 | 17 | 18 |
|------------------|-------|-----------|-------|-------|------|----|----|----|----|
| stability marker | space | character | mass | space | unit | | | CR | LF |

Stability marker [space] if stable
[?] if unstable
[!] if air buoyancy compensation mode is enabled
[^] if high limit is out of range
[v] if low limit is out of range

Character [space] for positive values
[-] for negative values

Mass 9 characters with decimal point, right justification

Unit 3 characters, left justification

Example:

--- -- **1 8 3 2 . 0 _ g _ _ CR LF** - a printout generated from a mass comparator upon pressing  key, according to settings of <Weighing printout template>:

| | | | |
|---------------------------|-----------|----------------------------|------------|
| N (measurements quantity) | NO | Universal variable 1 ... 5 | NO |
| Date | NO | Net | NO |
| Time | NO | Tare | NO |
| Level status | NO | Gross | NO |
| Customer | NO | Current result | NO |
| Warehouse | NO | Supplementary unit | NO |
| Product | NO | Mass | YES |
| Packaging | NO | Non-standard printout | NO |

24. PERIPHERAL DEVICES

Mass comparator can cooperate with the following peripheral devices:

- computer,
- receipt printer: EPSON,
- PCL6 printer,
- barcode scanner,
- fingerprint reader,
- an optional peripheral device operating ASCII communication protocol.

25. ERROR MESSAGES

Max weighing threshold exceeded
Unload the weighing pan

Min weighing threshold exceeded
Install weighing pan

Zeroing out of range
Press tarring button or restart the balance

Display capacity out of range
Unload the weighing pan

Tarring out of range
Press zeroing button or restart the balance

Start mass out of range
Install weighing pan

Zeroing/tarring time out of range
Weighing indication unstable

-no level- Balance not levelled

-Err 100- Weighing module restart

In process An ongoing process in the course of which the indication may be unstable
(automatic feeder – the process of feeding a pill, or mass comparator – the process of load change)













26. ADDITIONAL EQUIPMENT

| Type | Name |
|---------------------------|---|
| RTP-UEW80 lub RTP-RU80 | Dot printer |
| | PCL6 Printer |
| LS2208 | Barcode scanner |
| SAL | Anti-vibration table for XA series balances |
| | PC keyboard |

Computer software: „LABEL EDITOR”

27. APPENDIX B – Programmable Buttons List

| Pictogram | Function | Pictogram | Function |
|---|-----------------|---|---------------------------|
|  | Profile |  | Parameters |
|  | Adjustment |  | Produkt change |
|  | Zero |  | Warehouse change |
|  | Tare |  | Customer change |
|  | Set tare |  | Help |
|  | Disable tare |  | Edit universal variable 1 |
|  | Enable tare |  | Edit universal variable 2 |
|  | Packaging |  | Edit universal variable 3 |
|  | Print |  | Edit universal variable 4 |
|  | Header printout |  | Edit universal variable 5 |
|  | Footer printout |  | Working mode change |
|  | Units |  | Operator change |

| | | | |
|---|--------------------------------------|---|-----------------------------------|
|  | Statistics |  | Abort |
|  | Adding the measurement to statistics |  | Accept |
|  | Disable last digit display |  | Disable three last digits display |
|  | Disable two last digits display |  | Robot control |
|  | Reference weights |  | Test weight |
|  | Comparison procedure |  | Weights positioning wizard |
|  | Quick comparison | | |



RADWAG BALANCES AND SCALES
ADVANCED WEIGHING TECHNOLOGIES

