

# NEW MOISTURE ANALYZERS

WEIGHING SPEED, RELIABILITY, ACCURACY



**MA 60.3Y**

**MA 200.3Y**

- TOUCH SCREEN DISPLAY
- DRYING CHAMBER VENTILATION
- NEW SYSTEM OF DRYING CHAMBER ADJUSTMENT
- AUTO TEST
- DRYING PROCESS VISUALIZATION
- SAMPLE MASS CONTROL
- GLP SYSTEM
- DATABASES
- DYNAMIC CONTROLLING OF HEAT SOURCE
- WIDE RANGE OF APPLICATIONS



<p>Touch screen display Intuitive menu Customized settings</p>	<p>New system of drying chamber calibration</p>	<p>Quick determining of humidity content in different samples</p>	<p>Graphic interpretation of the humidity content trend</p>	<p>Communication Data exchange between MA.3Y series</p>
--	---	---	---	---

# MOISTURE ANALYZERS MA.3Y SERIES

## TOUCH SCREEN DISPLAY

INNOVATION, ERGONOMICS, OPERATION SPEED

Design of the moisture analyzer MA.3Y series comprises a colourful touch screen display that considerably increased its functionality. The solution enabled designing an interactive and INTUITIVE menu structure.

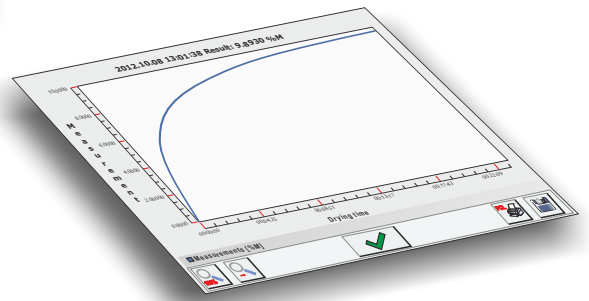

## HIGHLIGHTS

- Quick access to data related to a drying process
- Easy and clear programming of drying and tested sample parameters
- User defined settings
- Charts visualizing a process created in an on-line mode
- Multi-language system enabling adding new language versions to the menu

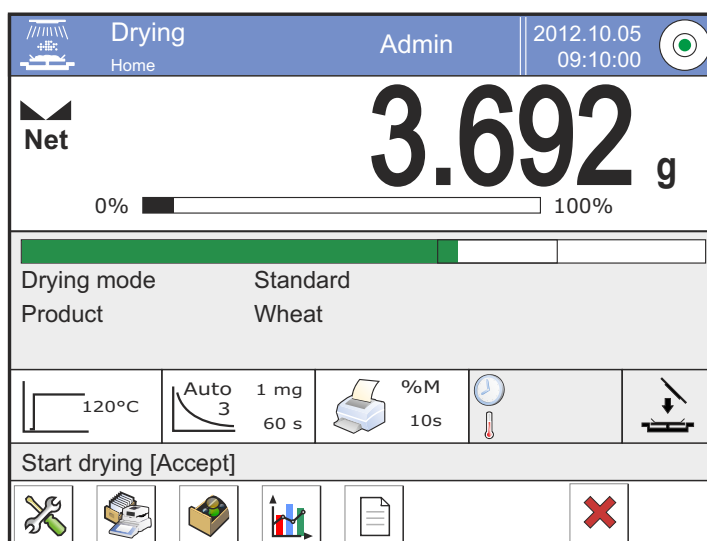

UPPER INFORMATION BAR

MAIN DISPLAY FIELD

WORKSPACE PROVIDING ACCESS TO OPTIONS ON A WORKING MODE

BAR PROVIDING ACCESS TO DRYING PARAMETERS

INFORMATION BAR

BOTTOM BAR WITH ACCESS TO THE MENU

MAIN SECTIONS OF THE TOUCH SCREEN DISPLAY

# MOISTURE ANALYZERS MA.3Y SERIES



## HIGHLIGHTS

- Quick humidity purging from the area over the tested sample
- Eliminating heat emission from the drying chamber to the weighing module

## MEANS OF OPERATION

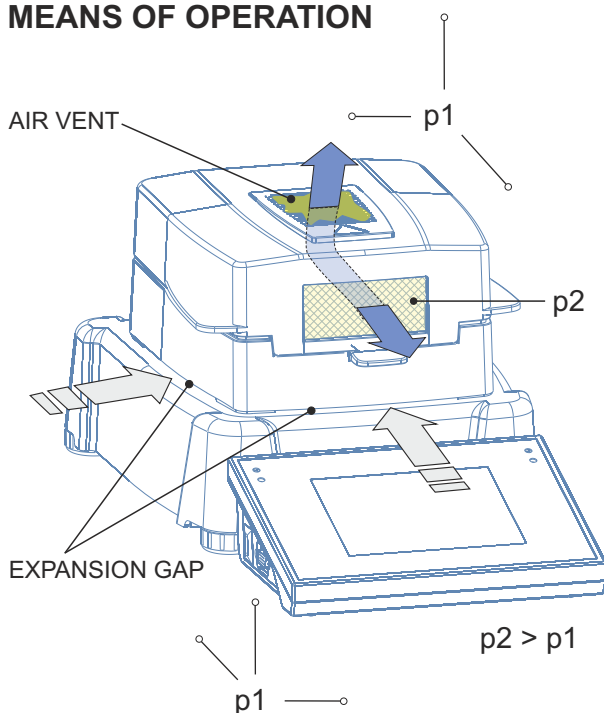

## BASIC ERROR OF A MOISTURE ANALYZER

When drying a sample with 0 (zero) humidity content (e.g. a standard), the start mass [ $m_1$ ] should equal to the end mass [ $m_2$ ]. If the [ $m_1 = m_2$ ] condition is maintained then the actual analysis of the sample is not burdened with an error.

## DRYING CHAMBER VENTILATION

### DRYING SPEED

Drying process requires that humidity is efficiently removed not only from the tested sample but also from the interior of the drying chamber. The solution uses natural air circulation arising from the difference in pressure occurring between two media (drying chamber interior  $p_1$  weighing room).

### EXPANSION GAPS

Air having higher temperature is removed from the area under the drying chamber by a fan located at its back section. Air exchange takes place in the dilatation gaps on the side and the front of the drying chamber, thus preventing heat emission from the drying chamber to the weighing module.

### AIR VENT

It considerably speeds up air removal and exchange in the drying chamber. The air vent enables limiting the systematic error caused by the difference in pressure generated while heating a tested sample.

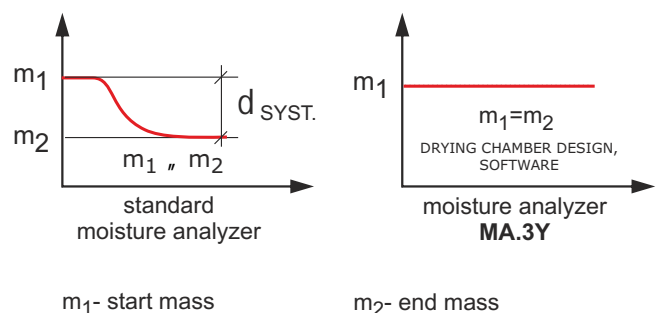

# MOISTURE ANALYZERS MA.3Y SERIES



## HIGHLIGHTS

- Unique position of the temperature sensor in relation to the drying pan surface
- Uniform temperature distribution
- Higher precision and accuracy of the adjustment process

## ADJUSTMENT SET – STRUCTURE



The adjustment set comprises a mechanical part [1] and a measuring module, i.e. a thermometer PT 105 [2]. Both components are connected together when manufactured. The measuring component [3] is located approximately 2 mm above the drying pan [4]. The thermometer cantilever [5] ensures its unique position in relation to the drying pan. The additional thermometer housing [6] stabilizes its temperature during adjustment process.

## NEW SYSTEM OF DRYING CHAMBER ADJUSTMENT

REPEATABILITY, SIMPLE OPERATION, UNIFORM TEMPERATURE DISTRIBUTION

A factor determining the humidity content in a sample is the drying temperature. Locating the control thermometer directly above the drying pan enables reading the temperature value close to the one of the drying pan (MA.3Y series). Therefore, the adjustment is carried out in thermal conditions equal to those occurring during a regular drying process. The determined adjustment factors are reliable and accurate.

## DRYING CHAMBER ADJUSTMENT

Drying chamber adjustment is a process intended to determine the temperature of the drying chamber interior in 3 static phases. The first one is the ambient temperature, and the following two are phases determined after heating intervals.

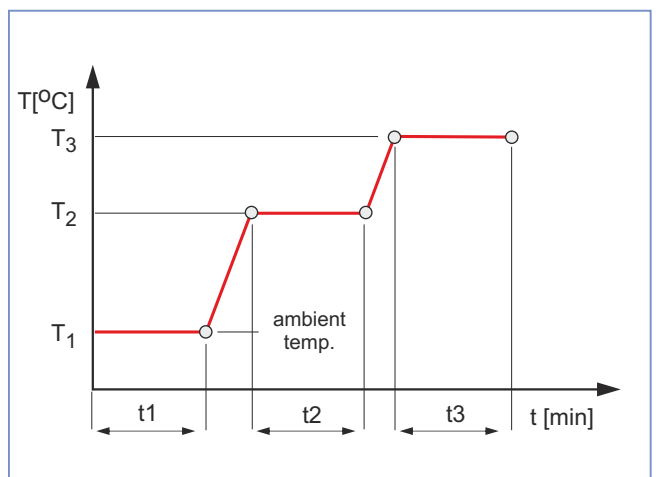

$$t_1 = t_2 = t_3$$

The adjustment and control processes can be carried out using the factory supplied adjustment set.

# MOISTURE ANALYZERS MA.3Y SERIES

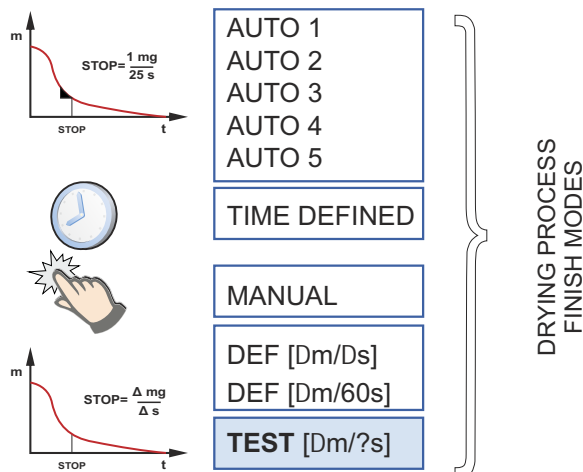
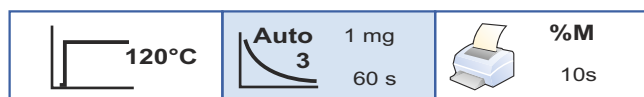

## HIGHLIGHTS

- Optimized drying time
- Improved repeatability
- Shortened time needed to create a drying methodology

## MEANS OF OPERATION

The test function analyses change of sample mass during drying process with automatically provides data on fulfilled time criterion of the finish modes: Auto 1 - 5. Select the finish mode for which the obtained value is the closest to the reference value.

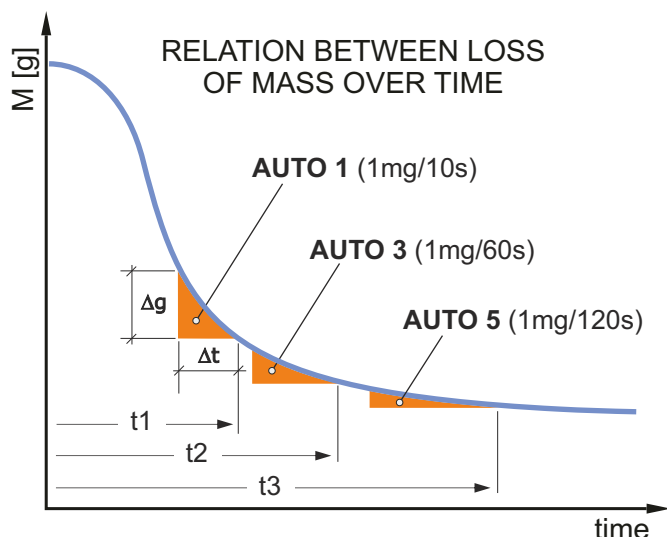

## TEST FUNCTION

### AUTOMATIC PROCEDURE OF DRYING PARAMETERS SELECTION

The moisture content result obtained in an analysis is conditioned by multiple factors. The main ones are drying temperature, finish mode, and sample size. Therefore, optimizing the drying parameters requires multiple tests, and it is time consuming.

The process can be partially automated using the Test function. The Test demonstrates which finish mode is the optimum one in a set drying temperature (convergence of the moisture content result with the reference value).

HEADER	
Initial mass	2.7548 g
0:00:10	0.1503 %M
0:00:20	0.6258 %M
----- Finish mode -----	
0:08:08	<b>Auto 1</b>
Result	11.4789 %M
0:08:10	11.4876 %M
0:08:20	11.5268 %M
----- Finish mode -----	
0:11:05	<b>Auto 2</b>
Wynik	11.9058 %M
0:11:10	11.9116 %M
0:11:20	11.9210 %M
----- Finish mode -----	
0:13:55	<b>Auto 3</b>
Wynik	12.0502 %M
0:14:00	12.0546 %M
0:14:10	12.0590 %M
----- Finish mode -----	
0:15:20	<b>Auto 4</b>
Wynik	12.0858 %M
0:15:30	12.0953 %M
0:15:40	12.0974 %M
0:18:10	12.1526 %M
----- Finish mode -----	
0:18:10	<b>Auto 5</b>
Wynik	12.1526 %M
FOOTER	

Diagnostic printout of the TEST function



# MOISTURE ANALYZERS MA.3Y SERIES

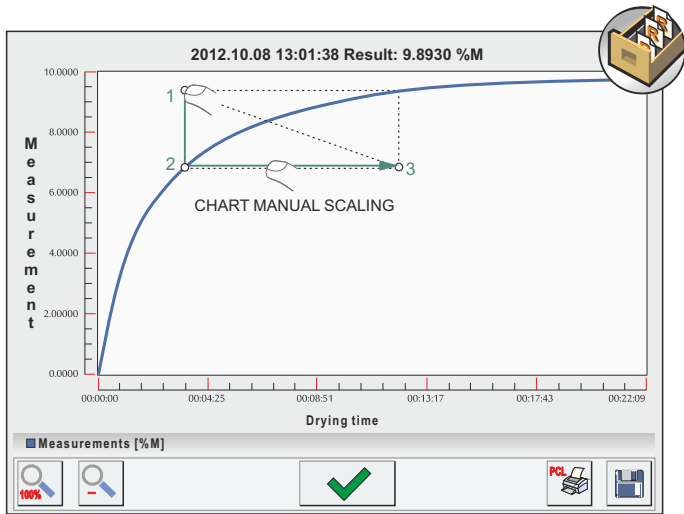

Moisture content – graphic interpretation

## HIGHLIGHTS

- Dynamic evaluation of a drying process (drying curve)
- Records of sample humidity content over time trend (monitoring)

Name	Wheat
Description	Typ 650
Code	432
EAN code	4014500006093
reference value	9,75 %
Unit	%M
Drying mode	Standard
Max	2,8 g
Min	3,5 g
Tolerance	1 %
Tare	0 g
Price	0

DATABASE - PRODUCTS

The analysis enables previewing different values, such as %M, %D, %r, g, chart.



## DRYING PROCESS VISUALIZATION GRAPHICS, DATA EXPORT, STATISTICS, TIME TREND

During a moisture analysis the majority of moisture analyzers enable previewing data on the start mass and humidity.

The newest RADWAG moisture analyzer MA.3Y series enables on-line tracking of the drying process visualized as a chart. The dynamics of chart's curve increase demonstrates sample ability to release free water. The drying curve is automatically saved in the database of completed drying processes, and can be optionally scaled or exported to a graphic file.

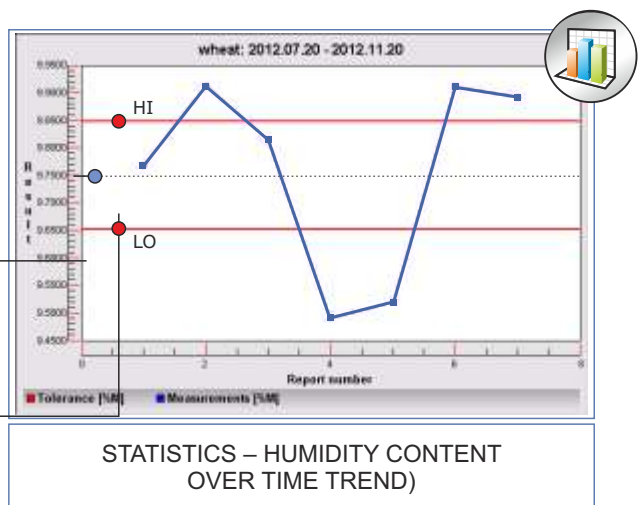



The results of drying analysis are easily used for monitoring humidity content over time trend of a specific product. The tolerance expressed in percent of the reference value allows for determining the high and low limits of the humidity content.

Now sample humidity content can be monitored in production stage, and verified on delivery.

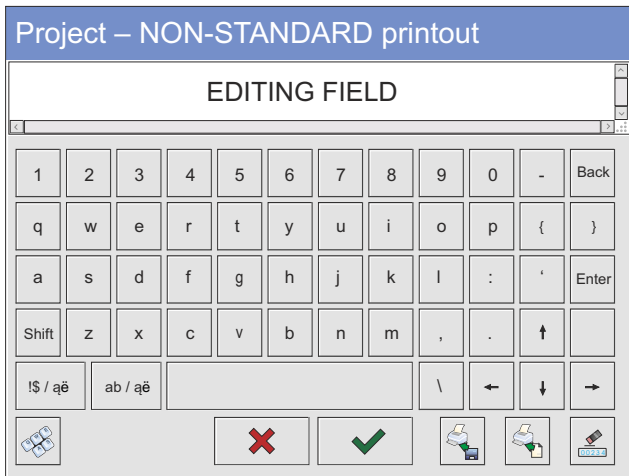
# MOISTURE ANALYZERS MA.3Y SERIES



 **FULL SCREEN MODE**  
(connect an external keyboard to terminal's USB port and start typing, the text space in unlimited).

 **IMPORT YOUR PRINTOUT**  
(connect an external data storage device to terminal's USB port and import ready printout templates to save time).

 **USE READY DATA**  
(fill your comments with ready to use variables and results of an analysis).

A NON-STANDARD printout enables creating user defined descriptions and comments, and applying default information (as in a standard printout template). The system enables designing multiple printout templates. Each printout consists of a Header, a Line and a Footer.

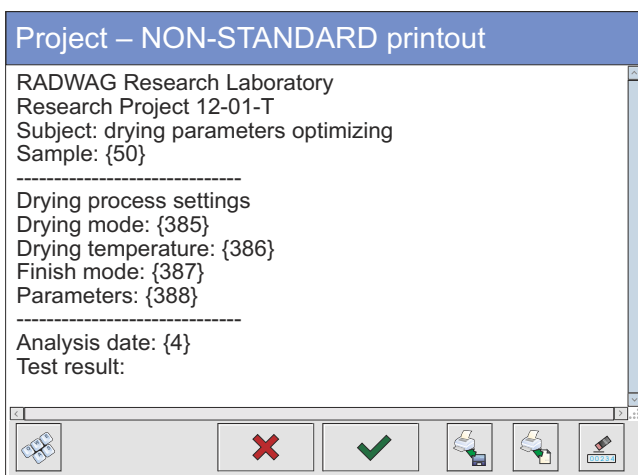

An example of  
a NON-STANDARD printout template

## DOCUMENTING A DRYING PROCESS

### STANDARD AND NON-STANDARD PRINTOUTS

The majority of applications requires that the test result is saved, printed or maintained in other format for future use, as required by a Quality System or product verification criteria during manufacturing process, storage or delivery.

In the MA.3Y series the procedures are realized by standard or optionally configured non-standard printout templates.

----- Drying -----	
Start date	2012.10.17
Start time	12:11:39
User	Admin
Product	ABS
Drying program	S\90\CZ\2
Drying mode	Standard
Drying mode parameters	90°C
Finish mode	Time defined
Start mass	9.6214 g
0:00:30	0.0414 %M
0:01:00	0.0479 %M
0:01:30	0.0523 %M
0:02:00	0.0561 %M
0:02:30	0.0604 %M
0:03:00	0.0644 %M
Status	Completed
End date	2012.10.17
End time	12:14:39
Drying time	0:03:00
User	Admin
End mass	9.6152 g
Current result	0.0645 %M

An example of  
a STANDARD printout template

Header
  Line
  Footer

A standard printout template consists of 3 sections. The content of each section is modifiable by selecting ready elements.

# MOISTURE ANALYZERS MA.3Y SERIES



No need to set any parameters. Communication is established immediately on connecting a printer to a moisture analyzer MA.3Y series.

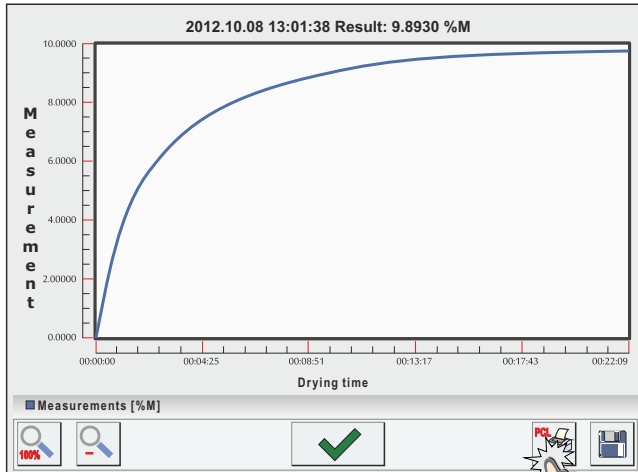

Humidity content graphic interpretation

The PCL enables printing data in a graphic format, for instance:

- Charts from drying processes (drying curve)
- Humidity content over time trend

## QUICK PRINTOUT PCL STANDARD

PRINTOUTS HAVE BECOME QUICKER AND SIMPLER

All moisture analyzers MA.3Y series cooperate with printers which implement the PCL (Printer Command Language) protocol. In practice your printouts from an analysis and summaries are easily printed on an optional office printer. A dedicated printer for the moisture analyzer is no longer needed.

RADWAG Research Laboratory  
Research Project 12-01-T  
Subject: drying parameters optimizing  
Sample: ABS

Drying settings  
Drying mode: Standard  
Drying temperature: 90°C  
Finish mode: Automatic 1  
Parameters: 1mg/10s

Analysis date: 2012.10.17 14:12:30

Test results:

0:00:10	0.1857 %M
0:00:20	0.2531 %M
0:00:30	0.2740 %M
0:00:40	0.2955 %M

Status Completed  
Carried out by:

Test carried out on MA 60.3Y  
Factory no.: 0  
Time and result of the analysis  
0:00:40 0.2961 %M

An example of a NON-STANDARD printout template

■ Header      ■ Line      ■ Footer



# MOISTURE ANALYZERS MA.3Y SERIES



## SAMPLE MASS CONTROL

### OPTIMIZED DRYING PROCESS ECONOMY

Optimized results of humidity content analysis depend on volume of a tested sample.

Too large sample mass usually results in long drying time. In case of valuable substances it means unnecessary economic loss. Too small mass of an analyzed sample prevents obtaining repeatable results. Therefore, sample mass control is obligatory.

Sample mass control in a moisture analyzer MA.3Y series is based two values: MIN and MAX. The parameters are determined in the database and they refer to a specific sample. Graphic presentation of the limits while weighing a sample aids selecting sample quantity.

Poprzez kontrolę masy próbki uzyskujemy:

- Optimized time of an analysis
- Repeatability of a drying series
- Efficiency in managing of tested substance

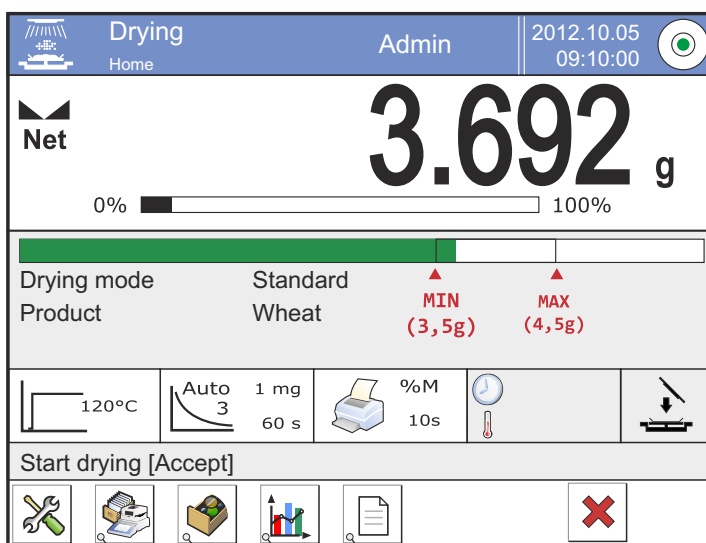

- 1 Drying mode
- 2 Databases (HOT KEY)
- 3 Chart (ON-LINE)
- 4 Sample description

Sample description is a prompt related to a carried out analysis. It consists of three main blocks:

1. Equipment related to a sample
2. Sample preparation
3. Recommended sample size

Data related to these fields are filled by a user when creating their own drying methodology.

# MOISTURE ANALYZERS MA.3Y SERIES

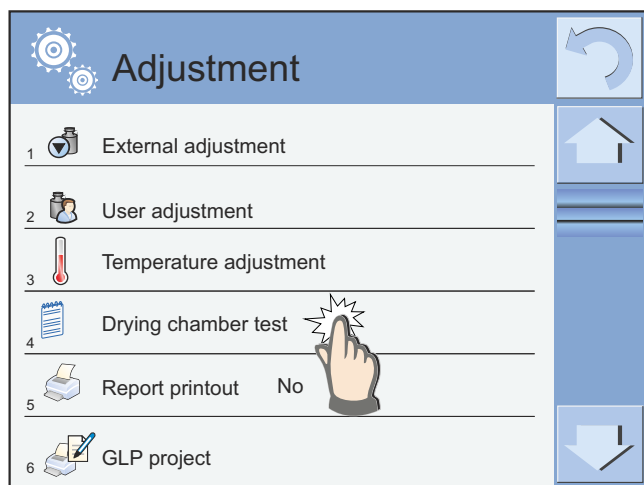

## HIGHLIGHTS

- Speed, uniqueness
- Customized printout templates (mass measurement)
- Automated control of drying temperature
- Selectable temperature of carried out test (optimization)

The correctness of temperature indications is monitored by a dedicated testing set and a software function "Drying chamber test". The procedure does not require simultaneous controlling mass as it is independent.

Correct operation of drying chamber is evaluated after stabilization period by comparing indications of a thermometer built in a moisture analyzer and an external control thermometer of the testing set.

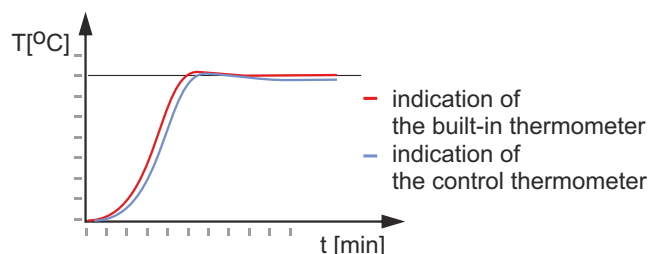
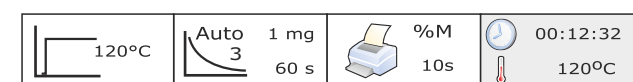

## GLP SYSTEM

### SEMI-AUTOMATIC PROCEDURES FOR CONTROLLING MASS AND DRYING TEMPERATURE

Mass measurement accuracy is ensured by the adjustment system with an external mass standard of appropriate accuracy class. On completing the adjustment procedure the moisture analyzer saves data and stores it in its memory (Menu: Adjustment History). Additionally, the adjustment result can be printed on a peripheral device. Printout content is defined by a user.

```

----- Adjustment: External -----
----- Weighing -----
Date                2012.10.10
Time                11:23:33
Balance type       MA 3Y.NP
Balance ID         342354
Operator           client
Level status       Yes
Difference          -0.0001
Temperature        30 °C
-----

Signature
    
```

An example of an adjustment report

Maximum permissible errors for mass standards ( $\pm$  dm in mg)

	ACCURACY CLASS			
	E <sub>1</sub>	E <sub>2</sub>	F <sub>1</sub>	F <sub>2</sub>
<b>50 g</b>	0,03	0,1	0,3	1,0
<b>200 g</b>	0,1	0,3	1,0	3,0

OIML R 111-1

Adjusting with a mass standard is obligatory if the moisture analyzer MA.3Y series is used for precise mass measurement processes.

# MOISTURE ANALYZERS MA.3Y SERIES



## HIGHLIGHTS

- Large capacity
- Quick access to data
- Detailed product description with related information
- Interactive, programmable database structure. Data export and import
- Data exchange between instruments – cloning



The databases can also store other data on users, operating conditions, marking types, required GLP data and more. The main database modules are:

- PRODUCTS
- WEIGHING RECORDS
- USERS
- DRYING PROGRAMS
- DRYING REPORTS
- STATISTICS FROM DRYING REPORTS
- AMBIENT CONDITIONS
- PACKAGES
- WAREHOUSES
- UNIVERSAL VARIABLES
- DELETE DATA OLDER THAN
- EXPORT DATABASE TO A FILE

## DATABASES

LIST OF PRODUCTS, MEASURING METHODS AND PROCEDURES, RECORDS ON COMPLETED ANALYSES, STATISTICS

Innovative technical concepts contained in the design and software of the MA.3Y series enabled forming an intuitive DATABASE. It is the basic data storing module on weighed samples, their characteristics, description, names, drying modes, humidity content and more. The information is used in an on-line mode during weighing and drying processes.



### PRODUCTS

sample description, tolerance of weighing and drying (min-max)



### WEIGHING RECORDS

electronic data archiving and previewing



### CLIENTS

access system to menu, data safety and user defined settings



### DRYING PROGRAMS

adjusting drying parameters to a sample (validation)



### DRYING REPORTS

drying analyses archiving (tabular or graphic)



### STATISTICS FROM DRYING REPORTS

humidity content over time trend for a sample

Optimal use of data contained in a database ensures speed and clarity of operation, and verification of all data related to weighing (drying).

# MOISTURE ANALYZERS MA.3Y SERIES



## DATABASE EDITOR

### DATABASE PROGRAMMING USING A COMPUTER SOFTWARE

Managing large amount of data requires care and frequent updating. In case of MA.3Y series this issue is solved by cooperation with a computer software Database Editor.

**Users**

- Users

**Databases**

- Products
- Weighing records
- Clients
- Drying programs
- Drying reports
- Ambient conditions
- Packages
- Warehouses
- Printouts
- Universal variables

**Settings**

Code	Name	Description
12	Mustard	Mustard
13	Soy beverage powdered	Soy beverage
14	Pistachio nut	Pistachio nut
15	Walnut	Walnut
16	Wheat bran	Wheat bran
17	PA 6	PA 6
18	Feedstuff	Feedstuff
19	Soy pate with mushroom	Soy pate with...
20	PC (polycarbonate )	PC (polycarb...
21	Pellet	Pellet
22	Black gingerbread	Black gingerb..
23	Cornflakes	Cornflakes
24	Dishwashing liquid	Dishwashing li..
25	Fabric softener	Fabric softener
26	Floor soap	Floor soap
27	Washing liquid	Washing liquid
28	Window cleaner	Window cleaner
29	POM (polioxymethylene)	POM
30	Ash	Ash
31	Egg powder	Egg powder
32	Wheat	Wheat
33	Smoke-box dust	Smoke-box d..
34	Coal dust	Coal dust
35	Rape	Rape
36	Gouda cheese slices	Gouda cheese..
37	Cream cheese	Cream cheese
38	Processed cheese	Processed ch...
39	Whey	Whet
40	Straw	Straw
41	Forest litter	Forest litter
42	Pasteurized cream	Pasteurized c...
43	Rapeseed meal	Rapeseed meal
44	Sunflower meal	Sunflower meal
45	Soybean meal	Soybean meal

**Product Configuration Panel 1 (Walnut):**

- Name: Walnut
- Description: Walnut
- Code: 3
- EAN code: 985432765432
- Target value: 4,23
- Unit: %M
- Tare: 0
- Max: 4,5
- Drying mode: [Dropdown menu with options: Soy beverage powdered, Pistachio nut, Walnut, Wheat bran, Candied papaya, Feed in pellets, Soy pate with mushroom]
- Min: [Empty]
- Tolerance: [Empty]
- Density: [Empty]
- Price: [Empty]
- Date: [Empty]
- Printout: [Empty]
- Ingredient: [Empty]
- No. of validity days: [Empty]
- VAT: [Empty]

**Product Configuration Panel 2 (Wheat bran):**

- Name: Wheat bran
- Description: Wheat bran
- Code: 22
- EAN code: 985432765429
- Target value: 8,98
- Unit: %M
- Tare: 0
- Max: 3,6
- Drying mode: Standard
- Min: 3,2
- Tolerance: 2
- Density: [Empty]
- Price: [Empty]
- Date: [Empty]
- Printout: Standard
- Ingredient: [Empty]
- No. of validity days: [Empty]
- VAT: [Empty]

The software features the same structure and the databases of the MA.3Y series and enables creating user defined drying methodology in a simpler and quicker way. IMPORT/EXPORT option ensures data security.

# MOISTURE ANALYZERS MA.3Y SERIES

## DATA BASE EDITOR

DATABASE PROGRAMMING USING A COMPUTER SOFTWARE



Products are quickly added to the database



Products managing and updating



Import database from a MA.3Y to a computer



Export database from the Database Editor application to a moisture analyzer



Export database from/to a .csv file (modifiable in a spreadsheet)

Code	Name	Description
12	Mustard	Mustard
13	Soy beverage powdered	Soy
14	Pistachio nut	Pistachio
15	Walnut	Walnut
16	Wheat bran	Wheat
17	PA 6	PA 6
18	Feedstuff	Feedstu
19	Soy pate with mushroom	Soy pate
20	PC (polycarbonate)	PC (pol
21	Pe	
22	Bl	
23	Co	
24	Di	

Database of products

Optionally defined content with customized descriptions

Databases contain information on drying and other carried out processes. The software contains the following databases: Products, Weighing Records, Clients, Drying Programs, Ambient Conditions, Packages, Warehouses and Universal Variables.

Name:	Walnut		
Description:	Walnut		
Code:	3	EAN code:	98543276
Target value:	4,23	Unit:	%M
Drying mode:	<ul style="list-style-type: none"> <li>Soy beverage powdered</li> <li>Pistachio nut</li> <li>Walnut</li> <li>Wheat bran</li> <li>Candied papaya</li> <li>Feed in pellets</li> <li>Soy pate with mushroom</li> </ul>		
Min:		Tare:	0
Tolerance:		Max:	4,5
Density:		No. of validity days:	
Price:		VAT:	
Date:			
Printout:	x		

Detailed information on a product



# MOISTURE ANALYZERS MA.3Y SERIES

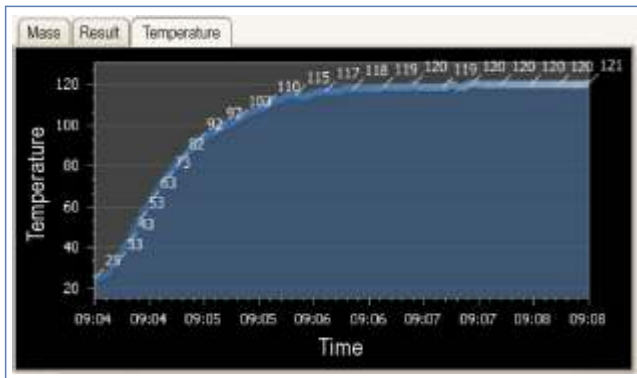

## HIGHLIGHTS

- On-line operation of up to 100 moisture analyzers
- Reports and charts from processes
- Network operation
- Programmable interface
- Different language versions
- Data stored in the MS SQL database

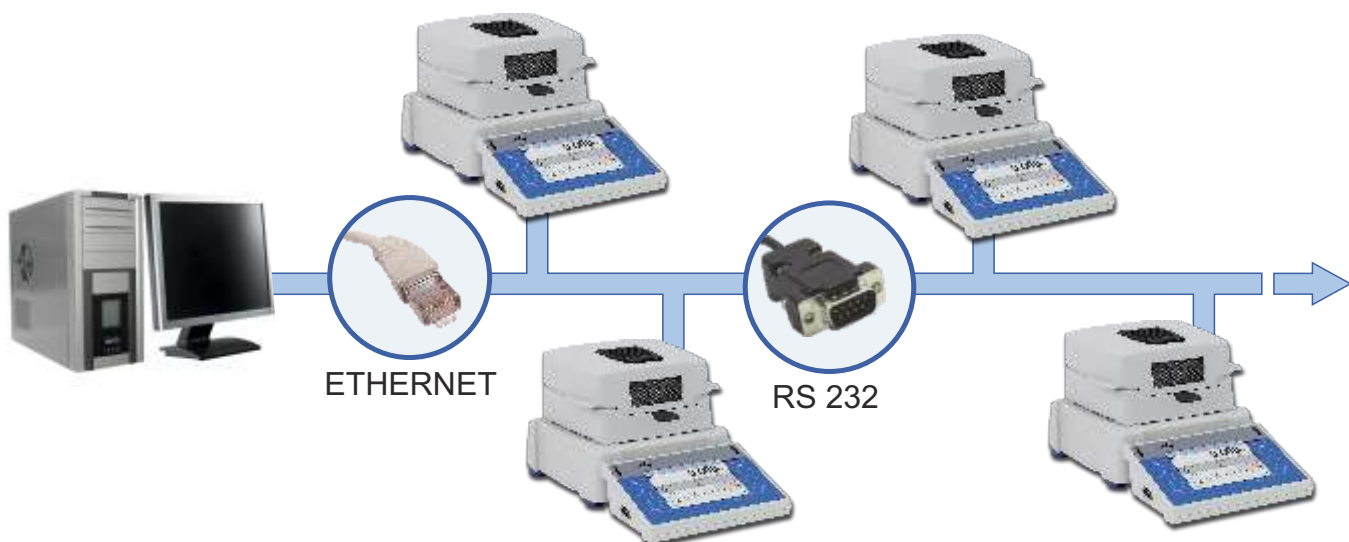

## COMPUTER SOFTWARE E2R MOISTURE ANALYZER

### MOISTURE ANALYZERS NETWORKING

Monitoring and reacting to obtained analysis results requires on-line access to information even if the workstations are distant from each other. In such case the supervision over the moisture analyzers MA.3Y series is enabled by networking them in a computer software E2R MOISTURE ANALYZER.

The software runs measurement archives and saves data in a computer database supported by MS SQL 2000 or 2005. Acquired data is used to on-line generating of charts and statements.

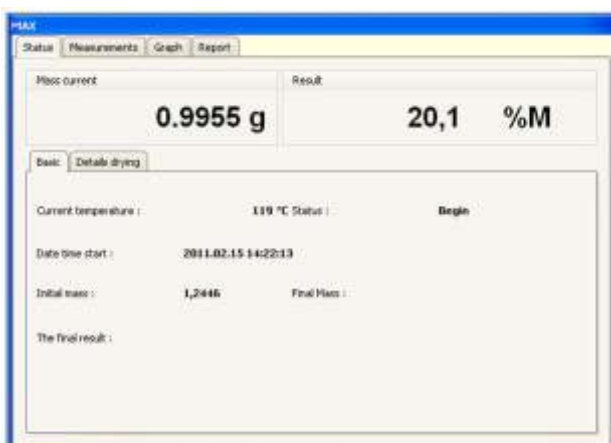

- Current mass in grams
- One of current results expressed in: %M, %D, %R, [g], chart,
- Current drying temperature
- Drying order status
- Start date and time of drying process
- Drying time
- Time of saving measurements in a database

# MOISTURE ANALYZERS MA.3Y SERIES

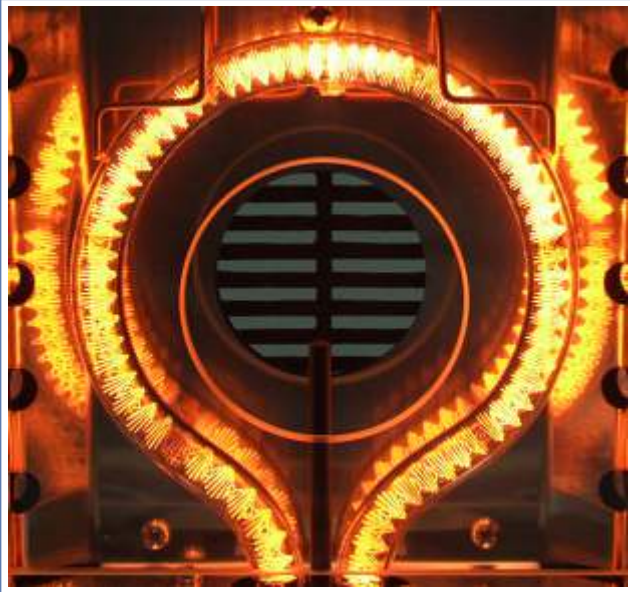

IRS (infrared short) wave length,  $\lambda = 1,2\mu\text{m}$   
IRM (infrared medium) wave length,  $\lambda = 3\mu\text{m}$   
IRL (infrared long) wave length,  $\lambda = 5\mu\text{m}$

A heat source in a moisture analyzer MA.3Y series is a medium length IR emitter. Highly stable feedback system with a temperature sensor ensures thermal stability during an analysis.

The method of dynamic temperature controlling in a drying chamber is one of elements intended to obtain short analysis time and repeatability of a drying series.

RADWAG designed method ensures drying temperature stability within  $\pm 2^\circ\text{C}$  in respect to set temperature value.

## HEATING MODULE

### INFRARED EMITTER IN DRYING PROCESSES

Halogens and IR emitters applied in a moisture analyzer use the phenomenon of wave emission within the range of  $0,75\ \mu\text{m}$  to  $1000\ \mu\text{m}$ . The generated heat is transferred onto a dried sample. Basically both heat sources are in fact the IR emitters but they operate at different wave length. Their naming results from the need to differentiate them.

### DRYING CURVES OF MOSTURE ANALYZERS FEATURING DIFFERENT HEATING MODULES

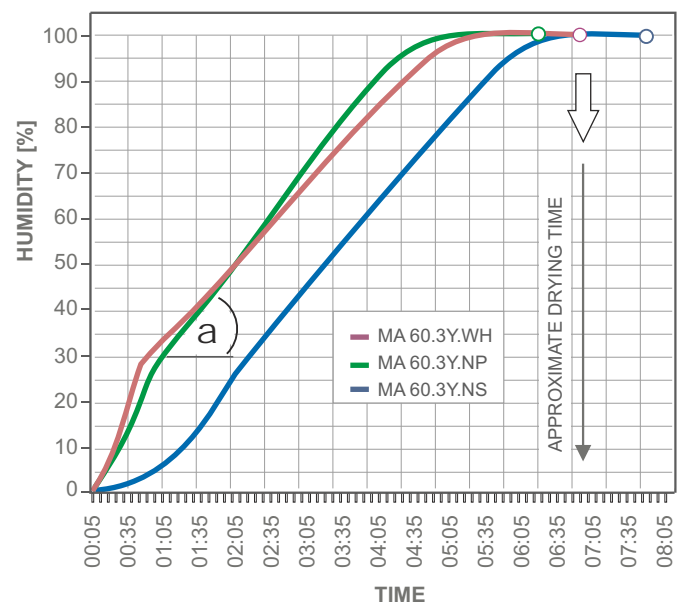

An IR emitter as a heat source is efficient when determining moisture content of materials such as powders, liquids, pastes, semi-fluid substances and solids.

# MOISTURE ANALYZERS MA.3Y SERIES

TECHNICAL DATA	MA 60.3Y	MA 200.3Y
Max capacity	60 g	200 g
Reading unit	0,1 mg	1 mg
Tare range	-60 g	-200 g
Max sample mass	60 g	200 g
Accuracy of moisture reading	0,0001 %	0,001 %
Repeatability	+/-0,24% (m<2g), +/-0,06% (m= 2-10g), +/-0,04% (m>10g)	
Drying temperature range*	max. 160° C	
Heating module**	Infrared emitter	
Maximum height of the tested sample	h= 20 mm	
Pan size	ø 90 mm, h= 8 mm	
Drying modes	standard, quick, step, mild	
Finish modes	Humidity stabilization, time defined, manual, custom	
Additional functions	Sample identification, drying chart	
Power of heating device	400 W	
Working temperature	+10° - +40 °C	
Interface	2 x USB 2.0; 4WE / 4WY; RS 232; Ethernet 10/100Mbit	
Power supply	230V 50Hz AC	
Display	5,7" colourful touch screen display	

\* Moisture analyzer available with maximum drying temperature upgraded to 250°C

\*\* Optionally available heating modules: halogen (max= 250°C), metal heater (max= 160°C)

## DRYING METHOD VALIDATION

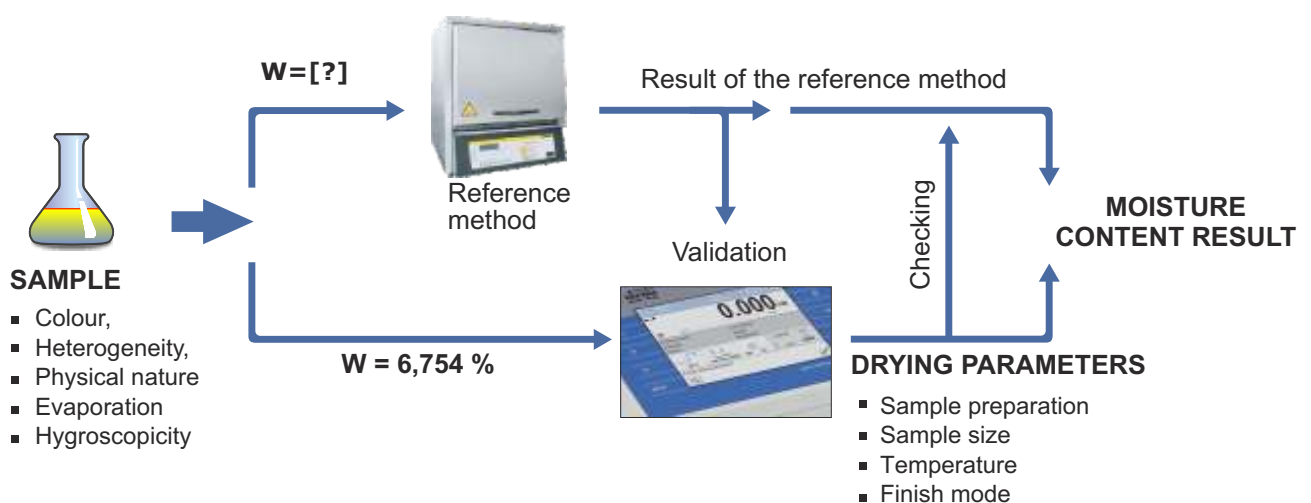

DRYING PROCESS VALIDATION FOR DIFFERENT SAMPLES IS CARRIED OUT BY RADWAG RESEARCH LABORATORY