

User Manual

Scales of Y series

Manual number:
ITKU-43-17-07-15-A



- **WLY Scales**
- **WPY Scales**



**MANUFACTURER OF ELECTRONIC
WEIGHING INSTRUMENTS**

RADWAG Wagi Elektroniczne, 26-600 Radom, Bracka 28, POLAND
Phone +48 48 38 48 800, fax. +48 48 385 00 10
export@radwag.com
www.radwag.com

JULY 2015

Table OF CONTENTS

1. INTENDED USE	9
2. PRECAUTIONARY MEASURES	9
3. WARRANTY CONDITIONS	9
4. UNPACKING AND MOUNTING	10
4.1. Scales of Y/C2, Y/F1 series	10
4.2. Scales of Y/D2 series	11
5. SCALE STRUCTURE	11
5.1. Main dimensions	11
5.2. Description of connectors	14
5.2.1. Connectors' description in PUE 7.1	14
5.2.2. Connectors' description in PUE 7.1P	14
5.2.3. Description of glands PUE 7.1P	14
5.2.4. Connector with RS232 and I/O	15
6. GETTING STARTED	15
6.1. Balance levelling	16
7. KEYPAD OVERLAY	16
8. FUNCTIONS OF KEYS	17
9. PROGRAM STRUCTURE	17
9.1. Main menu items	17
9.2. Inventory of parameters	18
9.2.1. Scale parameters - weighing	18
9.2.2. Working modes	19
9.2.3. Communication	25
9.2.4. Devices	27
9.2.5. Display	29
9.2.6. Inputs / Outputs	31
9.2.7. Authorization	32
9.2.8. Units	34
9.2.9. Other	34
9.2.10. User Adjustment	35
9.2.11. Info	36
9.2.12. Update	36
10. INDICATING WINDOW	37
10.1. Top bar	37
10.2. Weighing window	38
10.3. Workspace	38
10.4. Function keys	39
11. LOGGING IN	39
11.1. Logging in - procedure	39
11.2. Logging out procedure	40
11.3. Authorization access levels	40
12. NAVIGATING WITHIN THE MENU	41
12.1. Keys	41
12.2. Return to weighing	43
13. WEIGHING	43
13.1. Conditions of operational use	43
13.2. Zeroing	44
13.3. Tarring	45
13.4. Inscribing tare	45
13.5. Weighing for dual range scales	46
13.6. Toggling between weighing units	46
14. SCALE PARAMETERS	47
14.1. Median filter	47
14.2. Filter	48
14.3. Autozero	48
14.4. Minimum weight for different functions (LO)	49
14.5. Last digit	49
15. COMMUNICATION	50
15.1. RS 232 settings	50

15.2. ETHERNET setting.....	51
15.3. TCP protocol setting.....	51
15.4. Wi-Fi.....	52
15.4.1. Wi-Fi network status.....	52
15.4.2. Available networks.....	52
15.4.3. Transmission parameters.....	53
16. DEVICES.....	54
16.1. Computer.....	54
16.1.1. Computer port.....	54
16.1.2. Computer address.....	55
16.1.3. Continuous transmission.....	55
16.1.4. Weighing printout template.....	55
16.1.5. Cooperation with "E2R System".....	56
16.2. Printer.....	57
16.2.1. Printer port.....	58
16.2.2. Printer code page.....	58
16.2.3. Templates for printouts.....	58
16.3. Printouts activation.....	60
16.4. Barcode scanner.....	61
16.4.1. Port for barcode scanner.....	61
16.4.2. Prefix / Suffix.....	62
16.4.3. Field selection.....	62
16.4.4. Test.....	64
16.5. Transponder card reader.....	65
16.5.1. Com port for transponder card readers.....	65
16.5.2. Procedure of attributing the card number to an operator.....	66
16.6. Additional display.....	66
16.6.1. Additional display port.....	66
16.6.2. Communication protocol frame.....	67
16.7. Modbus RTU.....	67
16.7.1. Communication port.....	68
16.7.2. Address.....	68
16.8. Advanced settings.....	68
17. DISPLAY.....	69
17.1. Text strings.....	70
17.1.1. Display templates.....	70
17.2. Function keys.....	72
17.3. Displaying platforms.....	77
17.4. Bargraph.....	77
17.4.1. Bargraph type.....	77
17.4.2. Bargraph "Fast weighing".....	78
17.4.3. Bargraph "Signalling of checkweighing ranges".....	79
17.4.4. Bargraph type: „Linear".....	80
17.4.5. "Control" bargraph.....	81
18. INPUTS / OUTPUTS.....	83
18.1. Configuration of inputs.....	83
18.2. Configuration of outputs.....	84
19. AUTHORIZATION.....	85
19.1. Anonymous Operator.....	85
19.2. Date and time.....	86
19.3. Printouts.....	86
19.4. Databases edition.....	87
19.5. Delete older data.....	87
19.6. Set element from the database.....	88
19.7. CPG.....	89
20. UNITS.....	89
20.1. Units accessibility.....	89
20.2. Start unit.....	90
20.3. User defined units.....	91
20.4. Acceleration of gravity.....	91
21. OTHER PARAMETERS.....	92
21.1. Languages.....	92

21.2. Setting date and time.....	92
21.3. Sound signal.....	93
21.4. Screen volume.....	94
21.5. Screen brightness.....	94
21.6. Touch panel calibration.....	94
21.7. Energy saving mode.....	95
21.8. Screen timeout.....	95
21.9. Proximity sensor.....	96
21.10. Logging in required.....	96
21.11. Start logo.....	97
21.12. Error information preview time.....	97
21.13. Export / import of settings.....	98
22. USER ADJUSTMENT.....	98
22.1. Adjusting procedure.....	99
22.2. Start mass adjustment.....	100
22.3. Report from adjustment process.....	101
22.4. Adjustment track record.....	102
23. SOFTWARE UPDATE.....	102
23.1. ON-LINE updating.....	103
23.2. Update from pen drive.....	104
23.3. Changes in software.....	105
24. SPECIAL FUNCTIONS OF WORKING MODES.....	106
24.1. Working modes accessibility.....	107
24.2. Save mode.....	108
24.3. Down-weighing.....	108
24.4. Checkweighing.....	109
24.5. Tare mode.....	109
24.6. Labelling mode.....	110
24.6.1. Setting of the number of labels to print.....	111
24.6.2. Setting of the number of cumulative labels to print.....	111
24.6.3. Setting of the number of CC labels to print.....	111
24.6.4. Automatic triggering of cumulative labels.....	112
24.6.5. Automatic triggering cumulative labels of cumulative labels.....	113
24.7. Statistics.....	115
24.8. Differential weighing.....	115
24.8.1. Local settings.....	116
24.8.2. Reporting realized processes of differential weighing.....	116
24.9. Peak hold.....	116
24.10. Information about saved measurement.....	117
24.11. Packaging quantity query.....	118
25. WORKING MODE - WEIGHING.....	118
25.1. Starting the working mode.....	118
25.2. Local setting of a working mode.....	119
26. WORKING MODES – PARTS COUNTING.....	119
26.1. Starting the working mode.....	119
26.2. Local settings of the working mode.....	120
26.2.1. Automatic correction of reference mass.....	121
26.2.2. Minimum reference mass.....	122
26.3. Setting a reference unit by entering known piece mass.....	122
26.4. Setting a reference unit by weighing a sample.....	123
26.5. Setting the reference mass by entering single piece mass directly to the database.....	124
26.6. Inscribing the unit mass to the database.....	124
27. WORKING MODES – PERCENT SETUP (DEVIATIONS).....	124
27.1. Starting the operating mode.....	125
27.2. Local settings of the working mode.....	125
27.3. Reference unit mass estimated by weightment.....	126
27.4. Reference unit mass inscribing into the memory.....	126
28. WORKING MODES - DOSING.....	126
28.1. Starting the working mode.....	127
28.2. Dosing process structure.....	127
28.3. Local setting of a working mode.....	128
28.4. Description of functions and setting dosing process.....	129

28.5. Creating a new dosing process	132
28.6. Instances of dosing processes	133
28.6.1. Instance 1 – Manual dosing process of 4 ingredients on 2 weighing platforms	133
28.6.2. Instance 2 – Automatic dosing of 2 ingredients on 2 weighing platforms	135
28.6.3. Instance 3 – Mixed dosing process	137
28.7. Reporting of completed dosing processes	140
29. WORKING MODES – FORMULATION	141
29.1. Starting the working mode	141
29.2. Local setting of a working mode	142
29.3. Creating a new formulation	143
29.4. Formula making process	146
29.5. Reporting from completed formula making processes	148
30. WORKING MODE – CPG (CONTROL OF PREPACKED GOODS)	149
30.1. Starting the working mode	150
30.2. Control settings mode window	151
30.3. Local setting of a working mode	152
30.4. Editing a product to be controlled	152
30.5. Control start procedure	155
30.6. Control aborting procedure	156
30.7. Logging out from a control process in progress	157
30.8. Non-destructive average tare control mode	158
30.9. Performing non-destructive testing in mode Empty-Full	165
30.10. Performing destructive testing in modes Empty-Full and Full-Empty	166
30.11. Control in accordance with internal criteria	167
30.11.1. Abort of control - procedure	169
30.11.2. Procedure of control completion	170
30.12. Simultaneous carrying out two control processes	170
30.13. Report from estimating average tare	172
30.14. Report from product testing	173
31. WORKING MODES – DENSITY	176
31.1. Starting the working mode	176
31.2. Local setting of a working mode	176
31.3. Carrying out density determination procedure	177
31.3.1. Determining density of liquids	177
31.3.2. Determining density of solids	179
31.3.3. Determining density of pycnometer	180
31.3.4. Determining density of a porous body	182
31.4. Reporting from completed density determination processes	184
31.5. Table of density parameter for water	185
31.6. Table of density parameter for ethyl alcohol	185
32. WORKING MODES – ANIMAL WEIGHING	186
32.1. Starting the operating mode	186
32.2. Local setting of a working mode	186
32.3. Carrying out animals weighing procedure	187
33. WORKING MODE – VEHICLE SCALE	187
33.1. Working mode activating procedure	187
33.2. Working mode local settings	189
33.3. Vehicle transaction course	189
33.3.1. Entrance / Exit transaction	189
33.3.2. Control weighment transaction	193
33.4. Open transactions table	195
33.5. Printout templates for an ongoing transaction	195
33.6. Executed transactions – reporting	197
34. DATABASES	197
34.1. Database configuration	198
34.1.1. Databases accessibility	198
34.1.2. Categories	199
34.1.3. Database variables operation	200
34.1.4. Change name of an extra variables database	200
34.1.5. Change database records preview	201
34.1.6. Databases export / import	201
34.2. Searching databases	202

34.2.1. Quick name search	202
34.2.2. Quick code search	202
34.3. Adding new items in databases	203
34.4. Deleting items in databases.....	203
34.5. Printing items from databases	203
34.6. Context menu	204
34.7. Database edit window	205
34.7.1. Operators' database	205
34.7.2. Database of products	206
34.7.3. Database of clients	208
34.7.4. Database of dosing processes.....	208
34.7.5. Database of formulations	209
34.7.6. Database of PGC schedules.....	210
34.7.7. Database of vehicles	210
34.7.8. Database of identification processes	211
34.7.9. Database of packages.....	211
34.7.10. Database of warehouses	212
34.7.11. Database of labels	212
34.7.12. Database of universal variables	213
34.7.13. Extra variables database	214
34.7.14. Images database.....	214
35. REPORTS	215
35.1. Reports configuration	216
35.1.1. Reports accessibility	216
35.1.2. Configuration of a lot number.....	216
35.1.3. Configuration of a batch number.....	217
35.1.4. Query for number of weighings to be deleted	217
35.2. Deleting older data	218
35.3. Weighment date search.....	219
35.4. Reports from weighment records.....	219
35.4.1. Filtering.....	219
35.4.2. Report printout	220
35.4.3. Weighments chart.....	221
35.4.4. Export a database to a file	222
35.4.5. Counter of weighments records	225
35.5. Reports preview	225
35.5.1. Weighments / Alibi	225
35.5.2. Reports from dosing	227
35.5.3. Reports from recipes	227
35.5.4. Density reports	228
35.5.5. Controls reports	229
35.5.6. Average tare reports.....	230
35.5.7. Report from vehicle scale	232
35.5.8. Differential weighments reports.....	232
36. IDENTIFICATION PROCESSES	233
36.1. Identification process – creation	234
36.2. List of identification process functions	235
36.3. Identification process – activation procedure	237
36.3.1. Activation by programmable button.....	237
36.3.2. Activation by operator logging.....	238
36.3.3. Activation by product selection.....	238
36.3.4. Example of process forming and its realization	239
37. COMMUNICATION PROTOCOL.....	242
37.1. General information.....	242
37.2. List of RS commands	243
37.3. Respond message format.....	244
37.4. Command's description	244
37.4.1. Zeroing	244
37.4.2. Tarring	245
37.4.3. Get tare value	245
37.4.4. Set tare value	245
37.4.5. Send the stable result in basic unit	246

37.4.6. Send the result immediately in basic unit	246
37.4.7. Send immediate results from all platforms in basic units	247
37.4.8. Send the stable result in current unit	247
37.4.9. Send the result immediately in current unit	248
37.4.10. Switch on continuous transmission in basic unit	249
37.4.11. Switch off continuous transmission in basic unit	249
37.4.12. Switch on continuous transmission in current unit	249
37.4.13. Switch off continuous transmission in current unit	250
37.4.14. Set lower threshold	250
37.4.15. Set upper threshold	250
37.4.16. Read lower threshold	250
37.4.17. Read upper threshold	251
37.4.18. Simulation of pressing ENTER/PRINT key	251
37.4.19. Change platform	251
37.4.20. Give balance serial number	252
37.4.21. Set mass value of a single item	252
37.4.22. Set reference mass value	252
37.4.23. Activate sound signal	253
37.4.24. Give available working modes	253
37.4.25. Set working mode	254
37.4.26. Give current working mode	255
37.4.27. Send all implemented commands	255
37.5. Manual printouts / automatic printouts	256
38. MODBUS RTU COMMUNICATION PROTOCOL	256
38.1. Memory map	258
38.1.1. Output address	258
38.1.2. Input address	259
38.2. Description of variables	259
38.2.1. Output variables	259
38.2.2. Input variables	263
39. COOPERATION WITH PERIPHERAL DEVICES	266
40. DIAGRAMS OF CONNECTION CABLES	267
41. TECHNICAL PARAMETERS	269
41.1. Scales of WLY series	269
41.2. Scales of WPY series	270
41.3. Scales of WLY/KTP series	271
41.4. Scales of WPY/KTP series	272
42. ERROR MESSAGES	274
43. ADDITIONAL EQUIPMENT	274
44. APPENDIX A – Variables for printouts	275
44.1. Inventory of variables	275
44.2. Formatting variables	283
44.3. Mathematical function	285
45. APPENDIX B – Functions of programmable buttons	287
46. APPENDIX C – Label template	293
46.1. Designing a label from the terminal level	293
46.2. Designing a label on a computer	294
46.3. Saving label templates in the scale	298
46.4. Attributing a label to a product	298
46.5. Attributing a label to a client	299
46.6. Printing labels	299
47. APPENDIX D - CITIZEN printer setting	299
48. APPENDIX E - ZEBRA printer setting	300
49. APPENDIX F - Communication with barcode scanners	300
50. APPENDIX G – Computer Program „PGC Viewer”	301

1. INTENDED USE

Scales are the response for the market demands concerning simplicity of operation and high functionality. They are intended for quick and precise weighing in industrial and laboratory conditions. The state-of-the-art weighing terminal with TFT 5.7" colorful graphic displays with touch panels allows for intuitive operation without using keys.

Scales are equipped with 2 USB interfaces, 2 RS232 connectors, port Ethernet, 4 inputs /4 outputs (digital) and Wi-Fi b,g,n. They can cooperate with barcode scanners, receipt printers, label printers, transponder card readers (RFID) and standard PC equipment: mouse, keyboard, pendrives (limited use).

2. PRECAUTIONARY MEASURES

- A. Please, read carefully this user manual before and use the device according to its intended use;
- B. Weighed loads should be placed in possibly central part of scale pan;
- C. Do not clean the device with agents causing corrosion;
- D. Weighing pan should be loaded with goods having gross mass lower than maximal capacity of the scale;
- E. Do not leave loads on the pan for longer period of time ;
- F. In case of failure, immediately disconnect scale power supply;
- G. Devices that are to be withdrawn from usage should be utilized according to the law.

3. WARRANTY CONDITIONS

- A. RADWAG is obliged to repair or change those elements that appears to be faulty because of production and construction reason,
- B. Defining defects of unclear origin and outlining methods of elimination can be settled only in participation of a user and the manufacturer representatives,
- C. RADWAG does not take any responsibility connected with destructions or losses derives from non-authorized or inappropriate (not adequate to manuals) production or service procedures,

D. Warranty does not cover:

- Mechanical failures caused by inappropriate maintenance of the device or failures of thermal or chemical origin or caused by atmospheric discharge, overvoltage in mains or other random event,
- Inappropriate cleaning.

E. Forfeiture of warranty appears after:

- Access by an unauthorized service,
- Intrusion into mechanical or electronic construction of unauthorized people,
- Installing another operating system,
- Removing or destroying protection stickers.

F. The detailed warranty conditions one can find in warranty certificate.

G. Contact with the central authorized service:

+48 48 384 88 00 ext. 106 or 107.

4. UNPACKING AND MOUNTING

4.1. Scales of Y/C2, Y/F1 series

- A. Take the device out of the package,
- B. Put the scale on an even stiff ground,
- C. Remove transport protection:

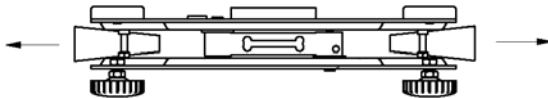

- D. Scale should be levelled by turning regulation feet. Levelling is correct if air bubble is situated in the central position:



4.2. Scales of Y/D2 series

- A. Take the device out of the package,
- B. Put the scale on an even stiff ground,
- C. Fit the pan and the bracket under the device according to the drawing:

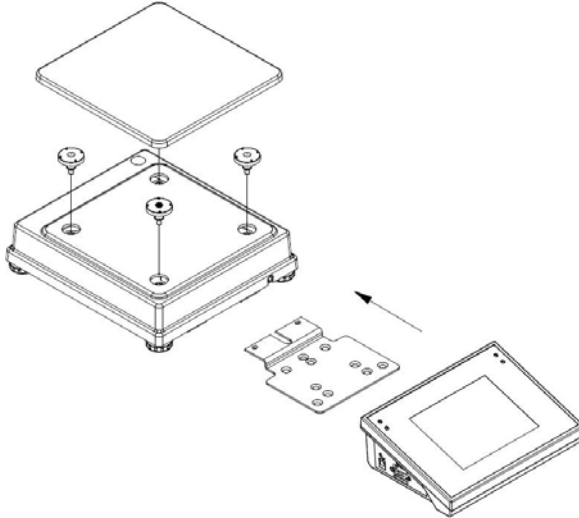

- E. Scale should be levelled by turning regulation feet. Levelling is correct if air bubble is situated in the central position:

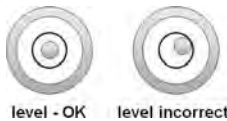

5. SCALE STRUCTURE

5.1. Main dimensions

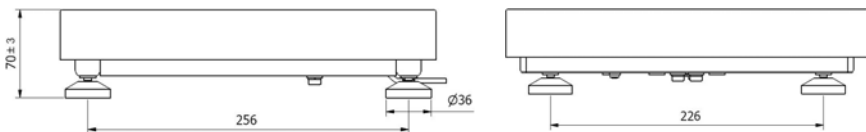

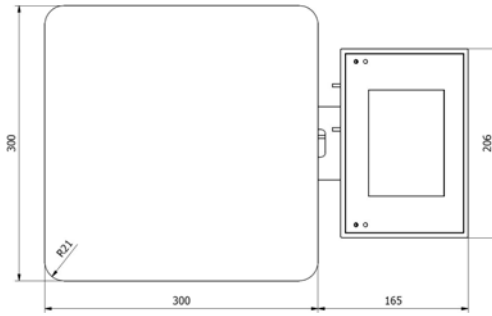

Y/F1/R series – main dimensions

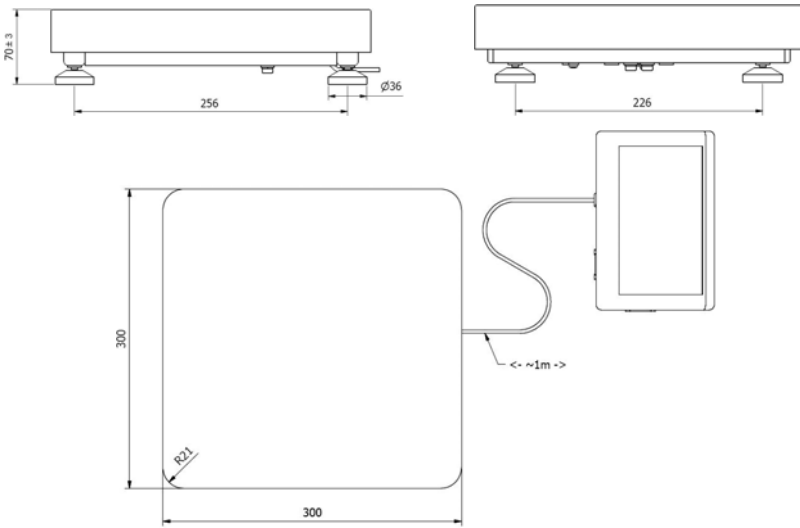

Y/F1/K series – main dimensions

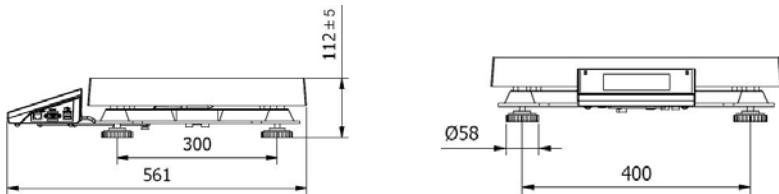

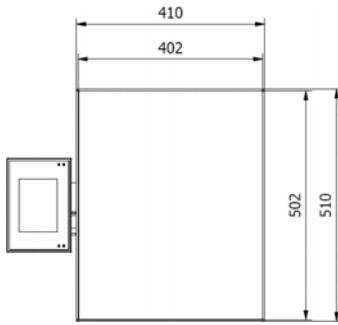

Y/C2/R series – main dimensions

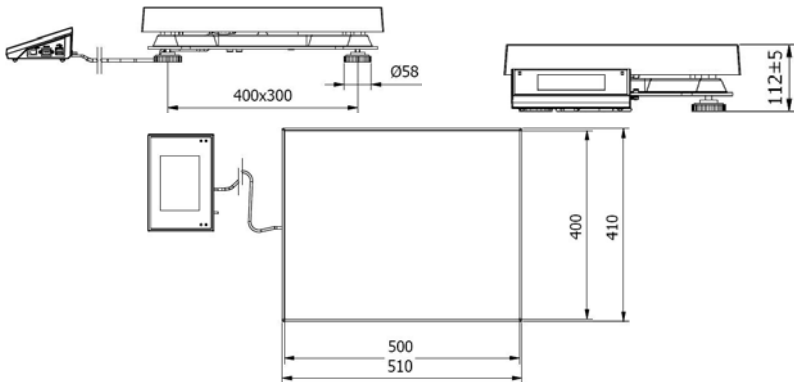

Y/C2/K series – main dimensions

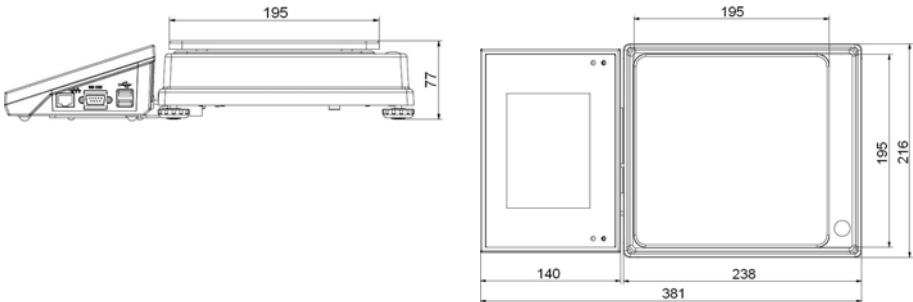

Y/D2 series – main dimensions

5.2. Description of connectors

5.2.1. Connectors' description in PUE 7.1

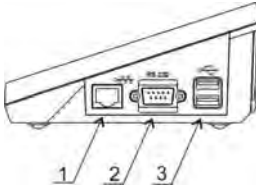

- 1 – Ethernet RJ45
- 2 – RS232 (COM1)
- 3 – USB

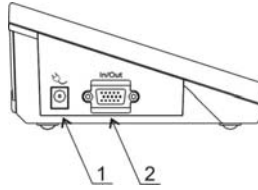

- 1 – power supply socket
- 2 – I/O, RS232 (COM2)

5.2.2. Connectors' description in PUE 7.1P

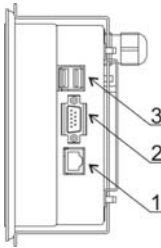

- 1 – Ethernet RJ45
- 2 – RS232 (COM1)
- 3 – USB

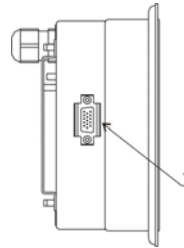

- 1 – I/O, RS232 (COM2)

5.2.3. Description of glands PUE 7.1P

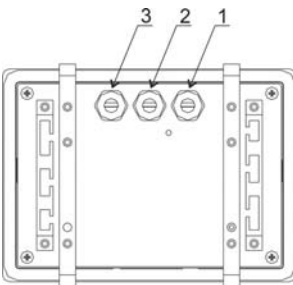

- 1 – Supply cord gland
- 2 – Gland for platforms 1, 2
- 3 – Gland for platforms 3, 4

5.2.4. Connector with RS232 and I/O

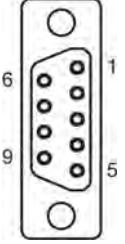
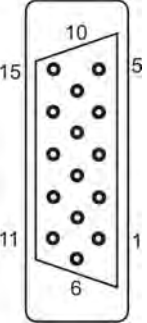
	<p>Pin2 – RxD Pin3 – TxD Pin4 – 5VDC Pin5 – GND</p>	<p>RS232 connector (COM1) DB9/M (male)</p>
	<p>Pin1 – GND_IN Pin2 - OUT1 Pin3 - OUT2 Pin4 - COMM Pin5 - 6÷9VDC Pin6 - IN4 Pin7 - IN3 Pin8 - TxD2 Pin9 - 5VDC Pin10 - GNDRS Pin11 - IN2 Pin12 - IN1 Pin13 - RxD2 Pin14 - OUT4 Pin15 - OUT3</p>	<p>IN/OUT connector, RS232 (COM2) DSUB15/F (female)</p>

6. GETTING STARTED

- After the terminal is connected to power the ON/LOAD diode starts to light.
- Press  to start the operating system loading procedure. Windows CE together with RADWAG software loading is signalled by blinking the red diode ON/LOAD.
- When the loading procedure is completed the main software window appears.

6.1. Balance levelling







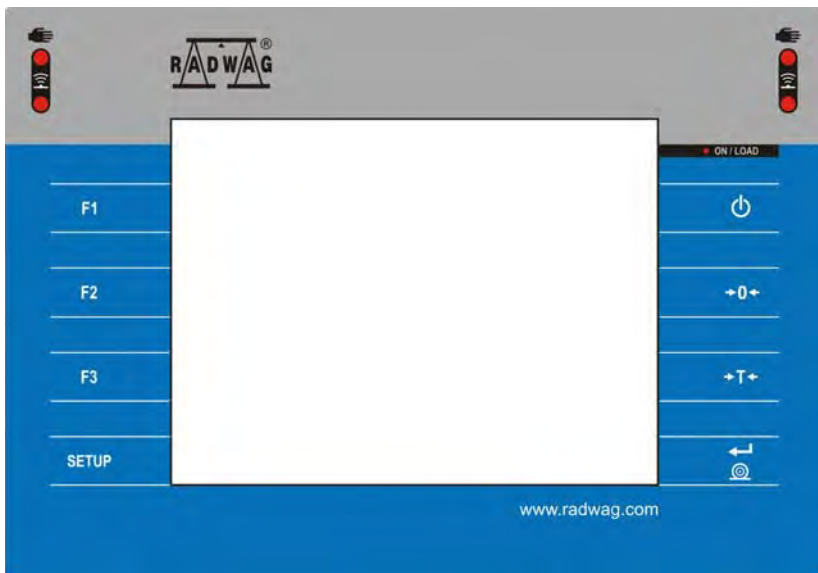

This applies to precision balances of WLY series

- For proper use of the device room temperature should be between + C°15 and + C°30;
- After switching on, the device needs the 30 minute warm-up time;
- During the thermal stabilization of the weighing scales the indication may drift;
- For verified weighing scales, user calibration should be performed after the warm-up time.

7. KEYPAD OVERLAY







8. FUNCTIONS OF KEYS











Key	Description
	Turning on/off the scale
	Zeroing
	Tarring
	Printing out the result or confirming some entered data
	Function key (entering the menu)
	Programmable key
	Programmable key
	Programmable key

9. PROGRAM STRUCTURE

The main menu has been divided into twelve functional groups. In every group there are parameters of similar use.







9.1. Main menu items

Pictogram	Description
	Scale
	Databases
	Reports
	Working Modes
	Communication

	Devices
	Display
	Inputs / Outputs
	Authorization
	Units
	Other
	User Adjustment
	Info
	Update
	Remote desktop



























9.2. Inventory of parameters



























9.2.1. Scale parameters - weighing

Pictogram	Description	Value
	Median Filter	0.5
	Filter	Fast
	Autozero	
	LO threshold	0.1
	Last digit	Always































9.2.2. Working modes





















Pictogram			Description	Value
			Accessibility	-
			Weighing	✓
			Parts counting	✓
			Percent setup	✓
			Dosing	✓
			Formulation	✓
			Animal weighing	✓
			Density	✓
			CPG	✓
			Vehicle scale	✓
			Weighing	-
			Save Mode	Manual, each stable
			Down-weighing	✓
			Checkweighing	✓
			Tare mode	Single
			Labelling mode	-
			Number of labels	1
			No. of cumulative labels	1















			No. of CC labels	1
			C label automatic triggering	-
			Mode	None
			Threshold	100
			CC label automatic triggering	-
			Mode	None
			Threshold	100
			Statistics	Global
			Differential weighing	-
			Activation	
			Batch portion type	Value
			Charge	1
			Min 2, Max 2 thresholds active	
			Peak hold	
			Information about saved measurement	
			Ingredient weight entered manually	
			Parts counting	-
			Automatic correction of reference mass	
			Minimum reference mass	10d
			Save Mode	Manual, each stable

				Down-weighing	
				Checkweighing	
				Tare mode	Single
				Labelling mode	-
				Number of labels	1
				No. of cumulative labels	1
				No. of CC labels	1
				C label automatic triggering	-
				Mode	None
				Threshold	100
				CC label automatic triggering	-
				Mode	None
				Threshold	100
				Statistics	Global
				Information about saved measurement	
				Ingredient weight entered manually	
				Percent setup	-
				Save Mode	Manual, each stable
				Down-weighing	
				Checkweighing	





			Tare mode	Single
			Labelling mode	-
			Number of labels	1
			No. of cumulative labels	1
			No. of CC labels	1
			C label automatic triggering	-
			Mode	None
			Threshold	100
			CC label automatic triggering	-
			Mode	None
			Threshold	100
			Statistics	Global
			Information about saved measurement	<input checked="" type="checkbox"/>
			Ingredient weight entered manually	<input checked="" type="checkbox"/>
			Dosing	-
			Ask for multiplier	<input checked="" type="checkbox"/>
			Ask for number of cycles	<input checked="" type="checkbox"/>
			Confirm batching ingredients manually	<input checked="" type="checkbox"/>
			No. of weighments for calculating the correction	0
			Automatic cycle	<input checked="" type="checkbox"/>
			Global	-























				Batching outputs	-
				Output 1	0
				Output 2	0
				Output 3	0
				Output 4	0
				Bulk batching output	-
				Output 1	0
				Output 2	0
				Output 3	0
				Output 4	0
				Correction	0
		MAX 		Maximum correctional value	0
				Formulation	-
				Ask for multiplier	
				Ask for number of cycles	
				Confirm batching ingredients manually	
				Automatic tare	
				Ingredient control	
				Portion weighing	
				Report printout	
				Animal weighing	-
				Averaging time	5
				Automatic mode	



			Checkweighing	<input checked="" type="checkbox"/>
			Tare mode	Single
			Labelling mode	-
			Number of labels	1
			No. of cumulative labels	1
			No. of CC labels	1
			C label automatic triggering	-
			Mode	None
			Threshold	100
			CC label automatic triggering	-
			Mode	None
			Threshold	100
			Statistics	Global
			Density	-
			Standard liquid	Water
			Temperature	21
			Standard liquid density	1
			Sinker volume	0
			Ask abort sample number	<input checked="" type="checkbox"/>
			Pycnometer mass	0
			Pycnometer density	0

		Unit	g/cm ³
		Save Mode	Manual, each stable
		Checkweighing	<input checked="" type="checkbox"/>
		Tare mode	Single
		Statistics	Global
		CPG	-
		Save Mode	Manual, each stable
		Number of accessible controls	1
		Ask for batch number	<input checked="" type="checkbox"/>
		Password required	<input checked="" type="checkbox"/>
		Vehicle scales	-
		Default transaction type	Entry
		Select vehicle	From a list
		Report printout	<input checked="" type="checkbox"/>

















9.2.3. Communication





















Pictogram		Description	Value
		RS 232 (1)	-
		Baud Rate	9600
		Data bits	8
		Stop bits	1
		Parity	None













		RS 232 (2)	-
		Baud Rate	9600
		Data bits	8
		Stop bits	1
		Parity	None
		Ethernet	-
		DHCP	
		IP Address	192.168.0.2
		Subnet mask	255.255.255.0
		Gateway	192.168.0.1
		DNS	192.168.0.1
		MAC Address	-
		Tcp	-
		Port	4001
		Wi-Fi	-
		Network status	-
		Available networks	-
		DHCP	
		IP Address	-
		Subnet mask	-
		Default gateway	-

		DNS	-
		Mac address	-







9.2.4. Devices

Pictogram		Description	Value
		Computer	
		Port	None
		Address	1
		Continuous transmission	<input checked="" type="checkbox"/>
		Weighing Printout Template	-
		E2R System	-
		 System is active	<input checked="" type="checkbox"/>
		 Lock selecting products	<input checked="" type="checkbox"/>
		Printer	-
		Port	RS 232 (1)
		Code page	1250
		Printouts	-
		 Weighing printout template	See ch. 16.2.3
		 Report From Weighments Printout Template	See ch. 35.4.2
		 Cumulative printout template	See ch. 16.2.3
		 Cumulative printout template for cumulative data	See ch. 16.2.3

		Adjustment report printout template	See ch. 22.3
		Dosing report printout template	See ch. 28.7
		Formulation report printout template	See ch. 29.5
		Printout Template of an Ingredient in a Formulation	See ch. 16.2.3
		CPG report printout pattern (Control of Packaged Goods)	See ch. 30.14
		Average tare report printout pattern (Control of Packaged Goods)	See ch. 30.13
		Entry Ticket Printout Template	See ch. 33.5
		Exit Ticket Printout Template	See ch. 33.5
		Control Weighment Ticket Printout Template	See ch. 33.5
		Report From Vehicle Scale Printout Template	See ch. 33.5
		Density printout template	See ch. 31.4
		Product printout template	See ch. 16.2.3
		Operator printout template	See ch. 16.2.3
		Client printout template	See ch. 16.2.3
		Warehouse printout template	See ch. 16.2.3
		Package printout template	See ch. 16.2.3
		Car printout template	See ch. 16.2.3
		Printouts activation	-
		Barcode reader	-
		Port	None
		Prefix	01

		Suffix	0d
		Field selection	See ch. 16.3.3
		Test	See ch. 16.3.4
		Transponder card reader	-
		Port	None
		Additional display	-
		Port	None
		Template	See ch. 16.5.2
		Modbus RTU	
		Port	None
		Address	1
		Advanced settings	-
		Number of printers	1





9.2.5. Display





Pictogram		Description	Value
		Text information	-
		Displaying template	See ch. 17.1.1
		Left displaying template	See ch. 17.1.1
		Right displaying template	See ch. 17.1.1
		Font	-
		Type	Courier

		Font size	Small
		Bold	
		Tilt	
		Colour	Black
		Background colour	Light grey
		Set Default	-
		Button functions	See ch. 17.2
		Show all platforms	
		Bargraph	-
		Bargraph type	None
		Fast weighing	-
		MIN, MAX thresholds working mode	Unstable
		OK threshold working mode	Unstable
		Min threshold signalling colour	Red
		OK threshold signalling colour	Intense green
		Max threshold signalling colour	Red
		Gradient	
		Background colour	Black
		Frame colour	White
		Signalling checkweighing ranges	-
		MIN, MAX thresholds working mode	Unstable
		OK threshold working mode	Unstable











		Min threshold signalling colour	Red
		OK threshold signalling colour	Intense green
		Max threshold signalling colour	Red
		Gradient	
		Background colour	Black
		Frame colour	White
		Linear	-
		Min threshold signalling colour	Red
		OK threshold signalling colour	Green
		Max threshold signalling colour	Red
		Min Max range background colour	Turquoise
		OK range signalling colour	Turquoise
		Gradient	

9.2.6. Inputs / Outputs

Pictogram		Description	Value
		Inputs	-
		Input 1	None
		Input 2	None
		Input 3	None
		Input 4	None

		Outputs	-
		Output 1	None
		Output 2	None
		Output 3	None
		Output 4	None

9.2.7. Authorization

Pictogram		Description	Value
		Anonymous operator	Operator
		Date & Time	Administrator
		Printouts	Administrator
		Databases edition	
		Products	Administrator
		Clients	Administrator
		Dosing processes	Administrator
		Formulations	Administrator
		Packages	Administrator
		Vehicles	Administrator
		Warehouses	Administrator
		Labels	Administrator
		Images	Administrator















	Traceability process	Administrator
	Weighing counter	Administrator
	Delete older data	Advanced Operator
	Set element from the database	-
	Products	Administrator
	Clients	Administrator
	Dosing processes	Administrator
	Formulations	Administrator
	Packages	Administrator
	Vehicles	Administrator
	Warehouses	Administrator
	Traceability process	Administrator
	Lot number	Operator
	Batch number	Operator
	CPG	-
	Batch number	Operator
	Batch size	Operator
	Sample quantity	Operator
	Average Tare Estimation	Advanced operator
	Tare	Operator
	Density	Advanced operator

9.2.8. Units

Pictogram	Description	Value
	Accessibility	-
	g	✓
	ct	✓
	lb	✓
	oz	✓
	N	✓
	Start unit	None
	Defined unit 1	-
	Multiplier	0
	Name	-
	Defined unit 1	-
	Multiplier	0
	Name	-
	Acceleration of gravity	9.80665





9.2.9. Other

Pictogram	Description	Value
	Language	English
	Date and Time	-
	Set date and time	-
	Date format	yyyy.MM.dd







		2013.03.29	11:10:09
		Beep	Yes
		Screen volume	0 %
		Screen brightness	90 %
		Touch screen calibration	-
		Energy saving mode	None
		Screen timeout	60 [s]
		Proximity sensor	2
		Log in required	<input checked="" type="checkbox"/>
		Start logo	-
		Error information preview time	Max
		Import	-
		Export	-

9.2.10. User Adjustment





An option only for non-verified scale

Pictogram	Description	Value
	Setting of start mass	-
	Adjustment	-
	Report printout	<input checked="" type="checkbox"/>
	Adjustment track record	-

9.2.11. Info

Pictogram	Description	Value
	Factory number	-
	Software version	2.7.3
	Version of weighing software	1.2.2
	Memory usage	FLASH: - [%]
	Image version	OS 1.0.0
	Wi-Fi	

9.2.12. Update

Pictogram	Description	Value
	Software version on server	Check version
	Update from server	-
	Update from pen drive	-
	Changes in software	-

10. INDICATING WINDOW

Main view:

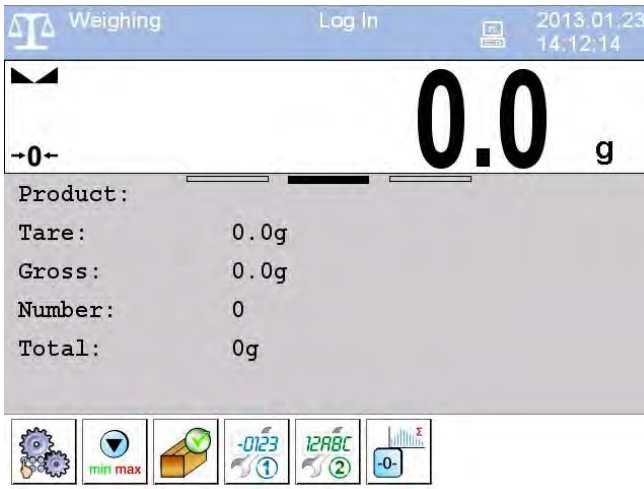



In the main application window one can see four separate parts:

- Top bar,
- Weighing window,
- Workspace,
- Function keys.

10.1. Top bar



The top bar on the display contains the following data:

 Weighing	Pictogram and name of an active working mode
Log In	Logged user
	Pictogram of an active connection with a computer
2012.06.06 06:06:06	Date and time

10.2. Weighing window

The weighing window contains data on carried out weighing process:



10.3. Workspace

The workspace is located under the weighing window:

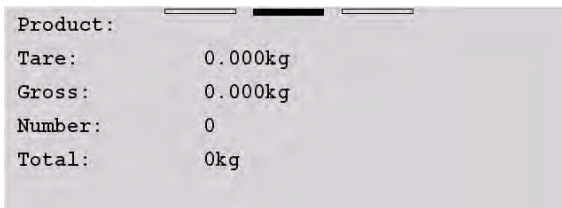

The workspace features three displaying templates. The upper section of the workspace comprises a graphic information on which of the three templates is enabled. Changing of the template is carried out by dragging the workspace to the right or left.

The data contained in the workspace is optionally programmable for each of the working modes. The default template format is described in point 17.1.1 of this user manual.

Caution:

An exception is an “initial workspace window” in the CPG mode, containing a logo and non-editable navigating line:

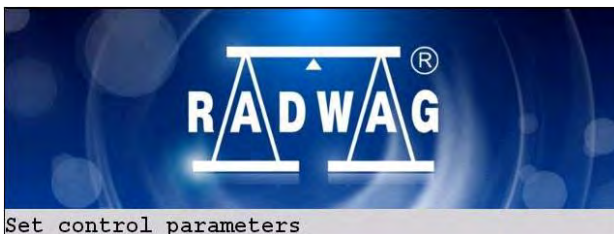

10.4. Function keys

Below the workspace area there is a set of on-screen function keys:



The on-screen function keys are editable in each of the available working modes. The procedure of enabling/disabling function keys is described in point 17.2 of this user manual.

11. LOGGING IN

In order to get full access to users parameters and to be able to edit database the user must log as an **<Administrator>**.

Caution:

For each brand new scale there is a default  **Admin** operator with **<Administrator>** authorization and no password. After the scales start the user automatically logs in as a default operator. If default operator data have been changed or if new operators have been added manual logging procedure is required.

11.1. Logging in - procedure

- Press **<Log in>** sign to open operators database window, **<Log in>** sign is located in the main window of an application at the top bar,
- Select a proper position and wait to see a screen keyboard with an edit field for an operator password,
- Enter the password and confirm it with  button,
- Program returns to the main window, the logged in operator name is displayed instead of **<Log in>** sign at the top bar of the main window.

11.2. Logging out procedure

- While in the main application window press the name of a logged in operator in the top bar on the screen to open the database of operators,
- Press Logging out button situated in the top bar of the operators' database window:



- The program returns to the main window and in the top bar the operators name is substituted by **<Log in>**.











11.3. Authorization access levels

There are four levels of authorization: Administrator, Advanced Operator, Operator, None.

Access to user parameters, databases and working modes depending on the authorization access level attributed:

Operator type	Access level description
None	No access to user parameters. No weighing can be confirmed. Cannot start procedure „CPG“. Cannot enter the reference mass unit and estimate the reference mass unit by weighing in „Counting Pieces“ and „Deviations“, density determination, carrying out dosing and formulation making processes. No access to <Export the weighing database to a file> in menu <Reports> ²⁾ .
Operator	Access to parameters in submenu: <Weighing>, <Display> ¹⁾ (excluding the group <Actions>), <Others> ¹⁾ . Can start and perform all weighing procedures. Access to <Export the weighing database to a file> in menu <Reports> ²⁾ .
Advanced Operator	Access to parameters in submenus: <Weighing>, <Working modes>, <Communication>, <Devices> ¹⁾ , <Display> ¹⁾ , <Others> ¹⁾ . Can start and perform all weighing procedures. Access to <Export the weighing database to a file> in menu <Reports> ²⁾ .
Administrator	Access to all user parameters, functions and databases ²⁾ . Can start and perform all weighing procedures.



1. Authorization level for editing functions:

-  **Printouts**> in submenu „ **Devices** /  **Printer**”,
-  **Sample**> in submenu „ **Devices** /  **Additional display**”,
-  **Displaying template**> in submenu „ **Display** /  **Text information**”,
-  **Date and Time**> in submenu  **Others**>,

The functions are declared in submenu  **Authorizations**>, which is accessible only for users with the **<Administrator>** authorization level (see ch. 19 of this manual).

2. A user logged in as **<Administrator>** in submenu



 **Authorizations**> (see ch. 19 of this manual) can change authorization levels for accessing different databases and functions:

 **Delete older data**>,  **Weighing counter**>. The exception are database  **Weighings / Alibi**>, that have the status „**Read only**”.

12. NAVIGATING WITHIN THE MENU

Owing to the colour display with the touch panel navigating within the menu is simple and intuitive.

12.1. Keys

	Entering the main menu
	Menu list „up”
	Menu list „down”



Scrolling „up-down”



Enter (OK)



Abort



Add a new item in a database



Disabling the formerly selected record e.g. Logging out the operator



Searching a database by date



Searching a database by name



Searching a database by code



Printing on item from a database



Exporting reports from testing and average tare
(for testing pre-packages mode PGC)



Clearing an editing field



Screen keyboard on / off



Reading a printout template from a *.lb file
(active after connecting a pen drive)



*Saving printout template in a file format *.lb (option enabled
on plugging a portable data storage device to scale port)*



Variables for a printout template





One level up



Immediate exit to the main window

12.2. Return to weighing

Changes made to the scale's settings are automatically saved in the memory on returning to the main software window. The scale provides two ways of returning to the main window:

- By pressing  key for a few times until returning to the main window,
- By pressing  key in the top bar, which causes immediate returning to displaying the main window.

13. WEIGHING

Put a load on the weight pan. When pictogram  is displayed the indication is ready to read.

Caution:

A weighing can be saved after stabilising a measurement (pictogram ).

13.1. Conditions of operational use

In order to assure a long term operating period with appropriate measurements following principles should be adhered to:

- Avoid applying mechanical shocks to the weight pan:

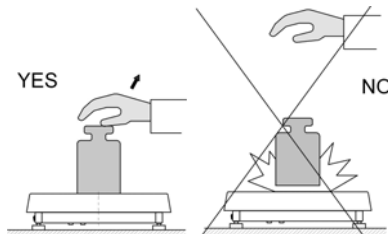

- Loads should be placed in the centre of the pan (eccentric errors are outlined in PN-EN 45501 chapter 3.5 and 3.6.2):

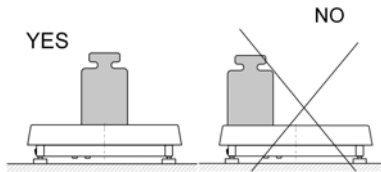

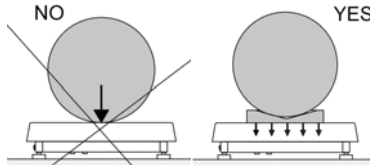

- Do not apply concentrated forces (all load in one point):

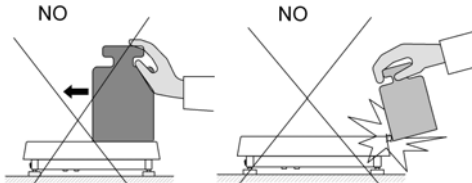

- Avoid side loads, particularly side strokes:



13.2. Zeroing

In order to zero the indication choose a platform on the touch panel and press . After zeroing is performed the indication is equal zero and following symbols usually appear: $\rightarrow 0 \leftarrow$ and .

Zeroing is possible only when the indication is stable.

Caution:

Zeroing is possible only within $\pm 2\%$ of full range around zero. If zeroing value is not within $\pm 2\%$ of maximal capacity the following message will be displayed:

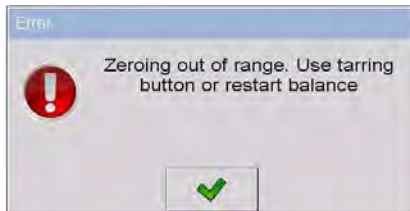

13.3. Tarring

In order to tare the scale choose a platform on the touch panel if necessary, put a package on the pan and press . You will see the indication equal zero and following symbols usually appear: **Net** and .

After placing a load on the weight pan net mass will be shown. Tarring is possible within the whole range of the scale. After unloading the pan the display shows the tarred value with minus sign.

You can also inscribe tare values to the product database. Every product has a field "Tare". In that case tare is automatically set to this value after selecting the product.

Caution:



Tarring cannot be executed when a negative or zero value is being displayed. In such case the following message will be displayed:



13.4. Inscribing tare

It is possible to inscribe a tare value.

Procedure:

- While in any work mode press , then the screen keyboard is displayed,
- Inscribe tare and press ,
- The program returns to weighing and the display shows the entered value with the „-“ sign provided there was zero before on the display.

13.5. Weighing for dual range scales

Switching between the **I range** and the **II range** happens automatically (exceeding Max of the **I range**).

Weighment in the second range is signalled by a pictogram in the top left corner of the display $\rightarrow|2|\leftarrow$. Then weighment is done with the accuracy of the **II range** to the moment of returning to zero (autozero range $\rightarrow 0 \leftarrow$) where the scale switches back to the **I range**.



Switching between the **II range** and **I range** is automatic both in the switching point the autozero zone. While in AUTOZERO – pictogram $\rightarrow 0 \leftarrow$ appears. Then pictogram $\rightarrow|2|\leftarrow$ is off and a scale returns to weighing in the **I range**.

13.6. Toggling between weighing units

Operators can change the weight unit in two ways:

- Pressing the unit symbol on the screen,
- Pressing formerly defined button \leftarrow  **Change unit** \rightarrow .

Possible selection:

- gram [g]
- kilogram [kg]
- carat [ct]
- pound [lb]
- ounce [oz] *
- Newton [N] *

*) – weighing unit inaccessible in a verified scale

Caution:

1. The user can also declare the start unit and determine two custom weighing units (user defined) – see point 20 of this user manual;
2. The procedure of attributing functions to buttons is described in ch. 17.2 of this manual.

14. SCALE PARAMETERS

Users can set the scale according to the ambient conditions (filtering level) or own needs (autozero) and set the LO threshold for minimum load that enables operation of some functions. These parameters are placed in

<  **Weighing**>.

In order to enter submenu <  **Weighing**>, press  and then: „ **Weighing**”.

Caution:

Weighing parameters are directly related to a specific weighing platform, so at the beginning the weighing platform should be selected for which we want to set parameters.

Inventory of scale parameters:

 Median Filter

 Filter

 Autozero



 LO Threshold

 Last digit

14.1. Median filter

The median filter is intended for eliminating short-lasting mechanical shocks.

Procedure:

- Enter <  **Weighing**> according to ch. 14 of this manual, select <  **Median Filter**> and then set an appropriate value.



Accessible settings:

None - median filter is off
0.5, 1, 1.5, 2, 2.5 - filtering level to choose

14.2. Filter

This filter is intended to suppress continuous mechanical vibrations at the cost of stabilization time.

Procedure:

- Enter <  **Weighing**> according to ch. 14 of this manual, select <  **Filter**> and then set an appropriate value.

Accessible settings:



None, V.Fast, Fast, Average, Slow.

Caution:

The higher filtering level the longer stabilization time.



14.3. Autozero

The autozero function has been implemented in order to assure precise indications. This function controls and corrects „0” indication.



While the function is active it compares the results continuously with constant frequency. If two sequential results differ less than the declared value of autozero range, so the scale will be automatically zeroed and the pictograms  and  and **0** will be displayed.

If AUTOZERO is disabled zero is not corrected automatically. However, in particular cases, this function can disrupt the measurement process e.g. slow pouring of liquid or powder on the weighing pan. In this case, it is advisable to disable the autozero function.

Procedure:

- Enter <  **Weighing**> according to ch. 14 of this manual, select <  **Autozero**> and then set an appropriate value.



Accessible settings:

-  - Autozero off
-  - Autozero on

14.4. Minimum weight for different functions (LO)

Parameter <LO THRESHOLD> is associated with automatic weighing. Next weighing will not be saved until the indication goes under the **THRESHOLD LO** (net).

Procedure:

- After entering < **Threshold Lo**> according to ch. 14 of this manual a keyboard is displayed,
- Inscribe LO and confirm by pressing .

14.5. Last digit

The last digit option < **Last digit**> is to switch off the last digit of measured mass indication – the measurement is carried out with decreased accuracy.

Procedure:





- Enter group of parameters < **Weighing**> in accordance with ch. 14 of this user manual, select parameter < **Last digit**> and set its desired value.

Accessible settings:

- | | |
|--------------------|--------------------------------------------------------|
| Always | - Last digit always visible |
| Never | - Last digit always switched off |
| When stable | - Last digit visible only on stable indication of mass |

15. COMMUNICATION

The scale can communicate with external devices via different ports:

-  RS232 (1),
-  RS232 (2),
-  Ethernet,
-  Tcp,
-  Wi-Fi.

The communication can be configured in parameters' group



<  **Communication** >.

In order to enter <  **Communication** >, press  and then:

„  **Communication** ”.

15.1. RS 232 settings

Procedure:



- Enter <  **Communication** > according to ch.15 of this manual, select <  **RS232 (1)** > or <  **RS232 (2)** >, and then set an appropriate value.

For RS 232 following parameters are accessible:

- Baud Rate - 4800, 9600, 19200, 38400, 57600, 115200 bit/s
- Data bits - 5, 6, 7, 8
- Stop Bit - No, 1, 1.5, 2
- Parity - No – Odd – Even – Mark – Space

15.2. ETHERNET setting



Procedure:

- Enter < **Communication**> according to ch.15 of this manual, select < **Ethernet**> and then set an appropriate value.

Following settings are accessible for Ethernet:

- DHCP - Yes – No
- IP Address - 192.168.0.2
- Subnet Mask - 255.255.255.0
- Default gateway - 192.168.0.1
- DNS - 192.168.0.1
- MAC Address - ---





Caution:

1. *The above settings are presented for information purpose only. Transmission parameters have to be selected in accordance with client's local network settings.*
 2. *Parameter <MAC Address> is automatically assigned to a device and it is has <Read only> Attribute.*
 3. *In case of declaring the <DHCP> parameter to value  and on device restart, the other transmission parameters have <Read only> attribute.*
- After making changes press  key, then a new message is displayed: <Restart to apply the changes>.
 - Go back to weighing and restart the device.

15.3. TCP protocol setting

TCP (*Transmission Control Protocol*) is a protocol for communication between two computers. It operates in mode client-server. Server awaits on connection initiation on a specified port while client initiates connection to the server. Scale software allows setting the port for the „**Tcp**” protocol.

Procedure:

- Enter < **Communication**> parameter group as described in chapter 16 of this manual,
- Select: „ **Tcp** /  **Port**” then you will see window <**Port**> with the screen keyboard,
- Enter the required number and press .

Caution:

The number of **TCP** port in **RADWAG** instruments is set to default value: **4001**.

15.4. Wi-Fi

15.4.1. Wi-Fi network status

In order to view selected network parameters click <**Network Status**> field. Displayed window provides the following parameters:





Name	Value	Description
Network	-	Network name
Network status	Connected	Network status with values: connected, disconnected
RSSI	- dbm - %	Signal strength
Forget the network	-	Disconnection from a selected network

Selected network and parameters set for connection are stored within the scale program, each time the scale is turned on it connects to the selected network in accordance with pre-set parameters.

15.4.2. Available networks

The user can view < **Available networks**> detected by the scale.

Procedure:



- Enter <  **Communications**> parameter group as described in chapter 15 of this manual,
- Go to <  **Wi-Fi** /  **Available networks**> submenu and select determined network out of the list,
- In order to search for available networks again, select <  **Refresh**> option.

Caution:



Pictogram located next to the network name, informs whether the network requires password or not (pictogram with a padlock).

15.4.3. Transmission parameters

Procedure:



- Enter <  **Communications**> parameter group as described in chapter 15 of this manual, select <  **Wi-Fi**> and set particular values.

For **Wi-Fi** the scale software provides the following transmission parameters:

DHCP	 Yes,  No
IP Address	192.168.0.2
Subnet mask	255.255.255.0
Default gateway	192.168.0.1
DNS	192.168.0.1
Mac address	---

Caution:



1. *The above settings serve only for information purposes. Transmission parameters must be set in order to comply with customer's local network settings.*
2. *< **MAC address**> parameter is assigned to a particular device automatically and it is characterised with < **Read only**> attribute.*

3. When setting **<DHCP>** parameter to  value and restarting the device, the remaining parameters are characterized with **<Read only>** attribute.
- With modifications carried out press  button, the following message is displayed **<Restart to apply the changes>**,
- Enter weighing mode and restart the device.

16. DEVICES

16.1. Computer

The scale can cooperate with a computer. Active connection **scale-computer** is signalled by icon  in the top bar of the main window. In submenu **<PC Computer>** some settings needs to be configured for cooperation with computers.

Enter submenu **<PC Computer>**, press  and then:
„ **Devices / PC Computer**”.

16.1.1. Computer port

Procedure:





- Enter parameters' group **<Handheld Scale Devices>** according to ch. 16 of this manual,
- Select „**PC Computer / Port**” and then set the appropriate option.

The scale can communicate with a computer via following ports:

- RS232 (1),
- RS232 (2),
- Tcp.





16.1.2. Computer address

Procedure:



- Enter < **Devices**> parameter group as described in chapter 16 of this manual,
- Choose „ **Computer** /  **Address**” then the window <**Address**> with the screen keyboard appears,
- Enter the required address and confirm it by pressing .

16.1.3. Continuous transmission



Users can enable continuous transmission from the scale to a computer.

Setting parameter < **Continuous transmission**> starts subsequent sending data from < **Weighing Printout Template**> set in submenu: „**Setup** /  **Devices** /  **Computer** /  **Weighing Printout Template**”.

Procedure:

- Enter parameters' group < **Devices**> according to ch. 16 of this manual,
- Choose „ **Computer** /  **Continuous transmission**” and then set an appropriate value.





Accessible settings:

-  - Continuous transmission off
-  - Continuous transmission on

16.1.4. Weighing printout template

Users in parameter < **Weighing Printout Template**> can define variables included in the printout from the scale to a computer.

Procedure:

- Enter < **Devices**> parameter group as described in chapter 16 of this manual,
- Choose „ **Computer** /  **Weighing Printout Template**” then the editing field <**Weighing Printout Template**> with the screen keyboard appears,
- Modify the template if necessary and confirm the changes by pressing .

Caution:

There are additional buttons in the bottom line of the screen keyboard. They can be used while modifying a printout template.:



Screen keyboard on/off



Reading a printout template from a *.lb file (button active while connecting a USB pen drive)



Saving printout template in a file format *.lb (option enabled on plugging a portable data storage device to scale port)



List of variables for printout templates (see the list in APPENDIX A of this manual)



Clear the editing field

16.1.5. Cooperation with “E2R System”





Scales can cooperate with computer software „**E2R System**” that is a modular system for complex production supervising by monitoring of weighments processes. In order to allow the cooperation with

„**E2R System**” enable parameter < **E2R System**>.



Caution:



*The parameter < **E2R System**> can be activated by an authorized service or the manufacturer.*

Procedure:

- Enter < **Devices**> parameter group as described in chapter 16 of this manual,
- Choose „ **Computer** /  **E2R System** /  **System is active**” and then set an appropriate value.



Accessible settings:

-  - System is not active
-  - System is active

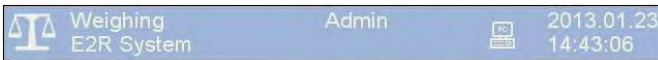
- If during cooperation with < **E2R System**> product selection lock is required for operators, go to parameter < **Lock selecting products**> and set its value to  .
- Active connection with the computer software is indicated by additional information displayed in the top bar of the software:



Where:

-  - parameter active < **System is active**>
-  - active connection with a computer software

16.2. Printer

In < **Printer**> submenu users can:

- Set communication with a printer,
- Set code page of a printer,
- Set templates of printouts,
- Activate/deactivate printout of demanded standards.

To enter < **Printer**>, press  and then: „ **Printer**”

16.2.1. Printer port

Procedure:

- Enter < **Devices**> parameter group as described in chapter 16 of this manual, choose „ **Printer** /  **Port**” and then select an appropriate option.

Printers can be attached to:

- RS232 (1),
- RS232 (2),
- USB,
- Tcp.

16.2.2. Printer code page

Procedure:

- Enter parameters < **Devices**> as described in chapter 16 of this manual,
- Choose „ **Printer** /  **Code Page**” then the screen keyboard will be displayed,
- Write the required code page and confirm by pressing .

Caution:

The default value is 1250 – code page for Middle-East Europe.

16.2.3. Templates for printouts

Enter < **Printouts**> to define printout templates.

Procedure:

- Enter parameter group < **Devices**> as described in chapter 16 of this manual, then choose „ **Printer** /  **Printouts**”,

- After editing a template a memo box with the default content and the screen keyboard,
- Modify the template according to your requirements and confirm it by pressing .

Caution:

There are additional buttons in the bottom line of the screen keyboard. They can be used while modifying a printout template.:



Screen keyboard on/off



*Reading a printout template from a *.lb file (button active while connecting a USB pen drive)*



*Saving printout template in a file format *.lb (option enabled on plugging a portable data storage device to scale port)*



List of variables for printout templates (see the list in APPENDIX A of this manual)



Clear the editing field

Default printouts' settings:



Weighing Printout Template

{0}



Weighments Report Printout Template

See ch. 35.4.2



Cumulative Printout Template

N={15} SUM={16}



Cumulative of Cumulative Printout Template

N2={20} SUM2={21}



Dosing Report Printout Template

See ch. 28.7



Formulation Report Printout Template

See ch. 29.5



Printout Template of an Ingredient in a Formulation

-















CPG Report Printout Template
(Control of Packaged Goods)

See ch. 30.14



Average Tare Report Printout Template
(Control of Packaged Goods)



See ch. 30.13

	Density Printout Template	See ch. 31.4
	Enter Ticket Printout Template	See ch. 33.5
	Exit Ticket Printout Template	See ch. 33.5
	Control Weighing Ticket Printout Template	See ch. 33.5
	Vehicle Scales Report Printout Template	See ch. 33.5
	Product Printout Template	{50} {51}
	Operator Printout Template	{75} {76}
	Client Printout Template	{85} {86}
	Warehouse Printout Template	{130} {131}
	Package Printout Template	{80} {81} {82}
	Vehicle Printout Template	{210} {211}
	Adjustment report printout template	See ch. 22.3



16.3. Printouts activation

 **Printouts activation** submenu enables activation/deactivation of demanded standards printout.

Procedure:

- Enter  **Devices** parameters group, following point 16 of this manual select „ **Printer** /  **Printouts activation**”,
- Activate/deactivate demanded standard intended for printout.

Where:

-  - Inactive standard
-  - Active standard

16.4. Barcode scanner

The balance allows for cooperation with a barcode scanner. The scanner can be used for quick search of:

- Products,
- Operators,
- Clients,
- Packages,
- Warehouses,
- Dosing process,
- Formulation,
- Universal variables,
- Lot number,
- Batch number.

Configuration of communication can be configured in:



“ /  **Devices** /  **Barcode reader**”.

Caution:

In submenu  **Communication** set the baud rate (default 9600b/sec). The detailed description of cooperation scale – barcode scanner can be found in **APPENDIX F** in this manual.

16.4.1. Port for barcode scanner



Procedure:

- Enter  **Devices** according to ch.16 of this manual, choose „ **Barcode reader** /  **Port**” and then set the appropriate value.

Barcode scanners can be connected to:

- RS232 (1),
- RS232 (2),
- USB.





16.4.2. Prefix / Suffix

Users can edit a prefix  <  **Prefix**> or / and suffix <  **Suffix**> in order to adjust the program to accept transmission frames from the scanner.

Caution:

*A special protocol is required in order the code be received by RADWAG equipment. It is required to program an appropriate prefix and suffix. Prefix – one byte 01 hexadecimally, suffix one byte 0D hexadecimally. The detailed description of cooperation scale – barcode scanner can be found in **APPENDIX F** in this manual.*



Procedure:

- Enter <  **Barcode Scanner**> according to ch.16.3 of this manual,
- Chose parameter <  **Prefix**> and then enter, using the screen keyboard, a required value (hexadecimal) and confirm it by pressing .
- Chose parameter <  **Suffix**> and then enter, using the screen keyboard, a required value (hexadecimal) and confirm it by pressing .







16.4.3. Field selection

This option is connected with selecting data which the program will search after reading a barcode.





Procedure:

- Enter <  **Devices**> according to ch.16 of this manual,
- Chose „  **Barcode Scanner** /  **Field selection**” and then the following list will be displayed:

-  Product
-  Operator
-  Client
-  Package



-  Source warehouse
-  Target warehouse
-  Dosing process
-  Formulation
-  Universal variable 1
-  Universal variable 2
-  Universal variable 3
-  Lot number
-  Batch number



- Select an item and then you can edit following parameters:

	Filtering	Declaring an item, according to which searching is supposed to be performed
	Offset	Setting the first significant character in code from which the comparison with items is performed during searching. All preceding characters are skipped
	Code length	Setting the number of characters to be taken for the search procedure counting from Offset
	Start marker	Start marker declaration
	End marker	End marker declaration





Caution:

An exception from the above is < **Formulation**>, which features an additional submenu < **Ingredient**> containing the following parameters:

	Filtering	Declaring an item, according to which searching is supposed to be performed (options: None , Code)
	Offset	Setting the first significant character in code from which the comparison with items is performed during searching. All preceding characters are skipped
	Code length	Setting the number of characters to be taken for the search procedure counting from Offset

	Start marker	Start marker declaration
	End marker	End marker declaration



Inventory of items to be selected for filtering:

Record	Item for filtering
Product	None, Name, Code, EAN Code
Operator	None, Name, Code
Client	None, Name, Code
Package	None, Name, Code
Source warehouse	None, Name, Code
Target warehouse	None, Name, Code
Dosing process	None, Name, Code
Formulation	None, Name, Code
Universal variable 1	None, Code
Universal variable 2	None, Code
Universal variable 3	None, Code
Lot number	 No,  Yes
Batch number	 No,  Yes

16.4.4. Test

Operators, using parameter  **<TEST> Test**, can verify if a barcode connected to the scale works properly.

Procedure:

- Enter submenu  **Barcode Scanner** according to ch. 16.3 of this manual,
- After entering parameter  **<TEST> Test** window **<Test>** is opened with an ASCII text box and HEX (hexadecimal) field,

- After scanning the code is entered to the ASCII field and HEX filed and at the bottom of the window a test result is displayed.

When:

- **<Prefix>** and **<Suffix>** declared in settings are the same as **<Prefix>** and **<Suffix>** in the read code then the test result is **<Positive>**,
- **<Prefix>** and **<Suffix>** declared in settings are not the same as **<Prefix>** and **<Suffix>** in the read code then the test result is **<Negative>**.

16.5. Transponder card reader

Each time after turning on the device, it is possible to select (log in) the operator using a transponder card reader and a transponder card.

Caution:

*In case of problems with reading transponder cards check the submenu  **Communication** and set appropriate baud rate (default 9600b/s).*

16.5.1. Com port for transponder card readers

Procedure:

- Enter group of parameters  **Devices** according to chapter 16 of this manual, select „ **Transponder cards reader /  Port**” and set appropriate option.





The scale can communicate with the reader via following ports:

- RS232 (1),
- RS232 (2).

16.5.2. Procedure of attributing the card number to an operator

To use a transponder card to log on an operator the card needs to be ascribed to the operator in the database of operators.



Procedure:

- Connect the transponder card reader to the required communication port (RS 232 (1) or RS 232 (2)),
- Choose a communication port for the reader (see ch. 16.4.1 in this manual),
- In submenu  **Communication**> set the baud rate to the same as in the reader (default 9600b/s),
- Enter the database of operators and edit the selected operator going to the field  **Card Number**>,

- After entering the field  **Card Number**> you will see the editing field **Card Number**> with the screen keyboard,
- Having approached the card to the reader the program automatically displays in editing field **Card Number**> the number of read card,
- Confirm the number by pressing  and return to weighing.

16.6. Additional display

16.6.1. Additional display port

Procedure:

- Enter parameters group  **Devices**> according to ch. 16 of this manual, select  **Additional display** /  **Port** and then choose an appropriate option from the list.

Communication with additional displays can be performed via following ports:

- RS232 (1),
- RS232 (2),
- Tcp.

16.6.2. Communication protocol frame





PUE 7.1 weighing indicator with following displays:

- WD display,
- WWG display.

To start cooperation of PUE 7.1 with displays go to parameter

< **Sample**> and define an appropriate communication protocol.

Procedure:

- Enter parameters' group < **Devices**> according to ch. 16 of this manual,
- Choose „ **Additional display** /  **Sample**” then the editing field <**Sample**> with the screen keyboard appears,
- Inscribe the required frame template using the screen keyboard or choose the it from the list after pressing .

Specified templates for displays:

- {141} - Protocol template for WD displays
- {142} - Protocol template for WWG display

- Confirm the changes by pressing .

Caution:

*In default settings parameter < **Sample**> has ascribed {141} (display WD series).*

16.7. Modbus RTU

Modbus RTU is a standard communication protocol determining means for exchange of information between two or more devices. **ModBus RTU** provides as fast data transfer as possible, wherein the data is monitored in order to provide that it is reliable.

Caution:

For detailed overview of memory map and of variables of Modbus RTU communication protocol go to chapter 38 of this manual.

16.7.1. Communication port

Procedure:





- Enter < **Devices**> parameter group as described in chapter 16 of this manual, select „ **Modbus RTU** /  **Port**” and set respective value.

Available values:

- None,
- RS232 (1),
- RS232 (2),
- Tcp.

16.7.2. Address





Procedure:

- Enter < **Devices**> parameter group as described in chapter 16 of this manual,
- select „ **Modbus RTU** /  **Address**” and wait to see <**Address**> window featuring an on screen keyboard,
- enter determined address and press  button to confirm.

16.8. Advanced settings

< **Advanced settings**> submenu enables declaration of printers cooperation with scales, cooperation of 1-3 printers may be declared.

Procedure:

- Enter parameters' group <  **Devices**> according to ch. 16 of this manual,
- Select „ **Advanced settings** /  **Number of printers**”, next set demanded number of printers (1, 2 or 3),
- <  **Devices**> parameters group will automatically be extended with new positions.





17. DISPLAY

Users can adapt the main display and visible information to their needs. All parameters of the display can be found in the parameters' group

<  **Display**>. Entering <  **Display**> can be made in two ways:

- Pressing  and then: „ **Display**”,
- Direct pressing the workspace area of the main display (does not apply to the “home screen” and “settings display” of the CPG (Control of Prepacked Goods mode)).

Inventory of parameters of the main display:











	Text information
	Button functions *
	Show all platforms
	Bargraph

*) – In case of the working mode **CPG**, the function keys are separately defined for:

- Home screen,
- Settings screen,
- Process screen.

17.1. Text strings

In  **Text information**> users can set:

		Display template	
		Left displaying template	Data displayed in the workspace. Detailed description in point 17.1.1.
		Right displaying template	
		Font	
		Type	Changing font type for text data displayed in the workspace. Available fonts: Arial, Courier.
		Font size	Declaring font size of text data displayed in the workspace. Available font size: Small, Medium, Large.
		Bold font	Bolded font for text data displayed in the workspace.
		Tilt	Text data in the workspace in italics.
		Colour	Font colour for text data in the workspace. Available in 18 colours palette.
		Background colour	Colour of the workspace background. Available in 18 colours palette.
		Set Default	Default settings for "Text data" submenu.

17.1.1. Display templates

The main window contains a workspace which displays optionally configured data specified for each working mode.

The workspace comprises three displaying templates:



- Displaying template,
- Left displaying template,
- Right displaying template.

The upper section of the workspace comprises a graphic information on which of the three templates is enabled. Changing of the template is carried out by dragging the workspace to the right or left.

Change of the displaying template is carried out in submenu:

“ /  **Display** /  **Text information**”.

Procedure:

- While in an optional weighing mode enter submenu < **Display**> in accordance with point 17 of this user manual,
- Select option < **Text information**> and then a desired displaying template, which is followed by displaying an editing field with its default content and an on-screen keyboard,
- Edit the content of the selected displaying template and accept it by pressing  key.

Caution:

There are additional buttons in the bottom line of the screen keyboard. They can be used while modifying a display template. :



Screen keyboard on/off



*Reading a template from a file with format *.lb (option enabled on plugging a portable data storage device to scale port)*



*Saving printout template in a file format *.lb (option enabled on plugging a portable data storage device to scale port)*



Selecting variables for a template from a list (list of variables is provided in the APPENDIX A of this user manual)







Clear the editing field

Default settings of a displaying template in each of the working modes:

CPG	Product: {50} Code: {51}
Weighing:	{40:Product:,-15}{50} {40:Tare:,-15}{9}{11} {40:Gross:,-15}{8}{11} {40:Number:,-15}{15} {40:Total:,-15}{16}{11}
Parts counting:	{40:Product:,-15}{50} {40:Sample weight:,-15}{35}{11} {40:Net:,-15}{7}{11} {40:Tare:,-15}{9}{11}
Percent setup:	{40:Product:,-15}{50} {40:Sample weight:,-15}{36}{11} {40:Net:,-15}{7}{11} {40:Tare:,-15}{9}{11}
Dosing:	Dosing process: {175}
Formulation:	{220} {40:Ingredient:,-12}{230}/{231}[{226}] {40:Portion:,-12}{228}{11}/{227}{11} {40:Charge:,-12}{232}/{233} {40:Completed:,-12}{225:F0}
Density:	Product: {50}
Animal weighing:	{40:Tare:,-15}{9}{11} {40:Gross:,-15}{8}{11}



17.2. Function keys

In submenu  **Actions**> users can set actions following keys:



















-  function keys,
-  screen keys,
-  proximity sensors.

Function keys and proximity sensors are programmable specifically for each working mode. If a button has been attributed then it is equal to activating a function. If no function is assigned to a button or sensor then it remains inactive.

Procedure:

- While in optional working mode go to submenu  **Display** in accordance with point 17 of this user manual,
- Choose  **Button functions** and choose a required setting for a chosen button: F1, F2, F3, 9 screen buttons or proximity sensors.

Default functions of buttons for working mode CPG:

Home screen		F1 Button	- Choose product
		F2 Button	- Choose client
		F3 Button	- Set tare
		Screen button 1	- Set control
Settings screen		F1 Button	- Choose product
		F2 Button	- Choose client
		F3 Button	- Set tare
		Screen button 1	- Local parameters
		Screen button 7	- Return to home screen
		Screen button 8	- Start
		Screen button 9	- Start
Process screen		F1 Button	- Choose product
		F2 Button	- Choose client
		F3 Button	- Set tare
		Screen button 6	- Data on control in progress
		Screen button 7	- Change: Workspace / chart
		Screen button 8	- Stop
		Screen button 9	- Stop

Default functions of buttons for other working modes:

Weighing:



F1 Button

- Choose product



F2 Button

- Choose client



F3 Button

- Set tare



Screen button 1

- Local parameters



Screen button 2

- Set MIN and MAX



Screen button 3

- Choose package



Screen button 4

- Edit lot number



Screen button 5

- Edit batch number



Screen button 6

- C Statistics : Zero

Parts counting:



F1 Button

- Choose product



F2 Button

- Choose client



F3 Button

- Set tare



Screen button 1

- Local parameters



Screen button 2

- Choose package



Screen button 3

- Insert unit mass



Screen button 4

- Estimate unit mass



Screen button 5

- Ascribe standard

Percent setup:



F1 Button

- Choose product



F2 Button

- Choose client



F3 Button

- Set tare



Screen button 1











- Local parameters















Screen button 2

- Choose package

Dosing:

	Screen button 3	- Insert mass of sample
	Screen button 4	- Estimate mass of sample
	F1 Button	- Select dosing process
	F2 Button	- Choose client
	F3 Button	- Set tare
	Screen button 1	- Local parameters
	Screen button 2	- Select dosing process
	Screen button 3	- Start
	Screen button 4	- Stop
	Screen button 5	- Emergency stop







Recipes:





	F1 Button	- Select formulation
	F2 Button	- Choose client
	F3 Button	- Set tare
	Screen button 1	- Local parameters
	Screen button 2	- Select formulation
	Screen button 3	- Start
	Screen button 4	- Stop
	Screen button 5	- Emergency stop
	Screen button 6	- Previous component
	Screen button 7	- Next component
	Screen button 8	- Give mass
	Screen button 9	- Edit lot number

Density:













	F1 Button	- Choose product
-------------------------------------------------------------------------------------	-----------	------------------

Animal weighing:

-  F2 Button - Choose client
-  F3 Button - Set tare
-  Screen button 1 - Local parameters
-  Screen button 2 - Determine liquid density
-  Screen button 3 - Determine solid density
-  Screen button 4 - Stop

-  F1 Button - Choose product
-  F2 Button - Choose client
-  F3 Button - Set tare
-  Screen button 1 - Local parameters
-  Screen button 2 - Start

Vehicle scale:

-  F1 Button - Choose a vehicle
-  F2 Button - Choose client
-  F3 Button - Set tare
-  Screen button 1 - Local parameters
-  Screen button 2 - Choose transaction
-  Screen button 3 - Choose transaction
-  Screen button 4 - Choose product
-  Screen button 5 - Choose product
-  Screen button 6 - Choose client
-  Screen button 7 - Choose client
-  Screen button 8 - Stop
-  Screen button 9 - Stop

Caution:

The list of functions that can be attributed to keys or buttons is listed in **APPENDIX B** of this manual.

17.3. Displaying platforms



If a scale is equipped with two platforms users can switch between platforms in three ways:

- By pressing the platform number on the scale screen,
- By pressing a formerly defined button  **Change platform**.
- By activating in parameters all platforms that will be separately placed in the main window of the program. In that case platforms can be activated by pressing the area of this platform.

Caution:

The procedure of attributing functions to buttons is described in ch. 17.2 of this manual.

To activate all platforms press , choose: „  **Parameters /  Display /   Show all platforms”**, and set appropriately.

-  - Displaying all platforms disabled
-  - Displaying all platforms enabled

17.4. Bargraph

A bargraph is a typical visualization procedure. It helps in quick weighing. It requires less concentration to read if a weighing is between minimum and maximum thresholds.

17.4.1. Bargraph type

To see the bargraph on the screen enable it in parameters.

Procedure:

- Enter submenu “  **Display /  Bargraph”** in accordance with point 17 of this user manual,

- Select option <  **Bargraph type**> and set desired bargraph type.

Accessible bargraphs:









- Quick weighing,
- None (Bargraph is not displayed),
- Signalling checkweighing ranges,
- Linear,
- Control *.

*) – Applies to the **CPG** mode only. In the **CPG** mode other bargraph types are not accessible.

17.4.2. Bargraph “Fast weighing”

Setting of bargraph type “**Quick weighing**” are accessible in submenu

„ **Display** /  **Bargraph** /  **Quick weighing**”:

	MIN, MAX thresholds working mode	Stable – signalling of MIN, MAX thresholds is previewed on exceeding LO threshold and reaching stable measurement result; Unstable – signalling of MIN, MAX thresholds is previewed on exceeding LO threshold
	OK threshold working mode	Stable – signalling of OK thresholds is previewed on exceeding LO threshold and reaching stable measurement result; Unstable – signalling of OK thresholds is previewed on exceeding LO threshold
	Min threshold signalling colour	Colour selection for signalling MIN threshold. 18 colours palette available.
	OK threshold signalling colour	Colour selection for signalling OK threshold. 18 colours palette available.
	Max threshold signalling colour	Colour selection for signalling MAX threshold. 18 colours palette available.
	Gradient	Enabling / Disabling filling effect “Gradient” type.
	Background colour	Colour selection of a bargraph background. 18 colours palette available.
	Frame colour	Colour selection of bargraph frame. 18 colours palette available.

Means of operation:



- The bargraph consists of 8 red fields and three green fields.











- The green fields signal weighments between MIN and MAX threshold, where:
 - MIN** = the minimum threshold of acceptable weighment - LO
 - MAX** = the maximum threshold of acceptable weighment - HI
- If a measurement is over the MIN (to the value of 1/3 of MIN-MAX) the green field with a triangle on the left is visible. If the measurement is between 1/3 and 2/3 of MIN-MAX the rectangular green field is visible. If the measurement is between 2/3 of MIN-MAX and MAX a green field with a triangle on the right is visible.
- If the mass value is below the MIN threshold red fields with red arrows on the left are visible. The lower mass value the more red arrows are visible.
- If the mass value is over the MAX threshold red fields with red arrows on the right are visible. The higher mass value the more red arrows are visible.

Thresholds MIN and MAX are on the borders between red and green fields.

17.4.3. Bargraph “Signalling of checkweighing ranges”

Settings of “**Signalling checkweighing ranges**” bargraph are accessible in submenu “ **Display** /  **Bargraph** /  “**Signalling checkweighing ranges**”:

	MIN, MAX thresholds working mode	<p>Stable – signalling of MIN, MAX thresholds is previewed on exceeding LO threshold and reaching stable measurement result;</p> <p>Unstable – signalling of MIN, MAX thresholds is previewed on exceeding LO threshold</p>
-------------------------------------------------------------------------------------	----------------------------------	-------------------------------------------------------------------------------------------------------------------------------------------------------------------------------------------------------------------------------------------

	OK threshold working mode	Stable – signalling of OK thresholds is previewed on exceeding LO threshold and reaching stable measurement result; Unstable – signalling of OK thresholds is previewed on exceeding LO threshold
	Min threshold signalling colour	Colour selection for signalling MIN threshold. 18 colours palette available.
	OK threshold signalling colour	Colour selection for signalling OK threshold. 18 colours palette available.
	Max threshold signalling colour	Colour selection for signalling MAX threshold. 18 colours palette available.
	Gradient	Enabling / Disabling filling effect “Gradient” type.
	Background colour	Colour selection of a bargraph background. 18 colours palette available.
	Frame colour	Colour selection of bargraph frame. 18 colours palette available.

Means of operation:

- This type of bargraph comprises one green and 2 red fields.









- **The left red field** – signals that the load on the pan is lower than the minimum weighing threshold (**Min** threshold);
- **The central green field** – signals that the load on the pan is within the set required interval for the weighed product (**OK** value between **Min** and **Max** thresholds);
- **The right red field** – signals that the load on the pan is greater than the maximum weighing threshold (**Max** threshold).

17.4.4. Bargraph type: „Linear”

Settings of “Linear” bargraph are accessible in submenu

“ Display /  Bargraph /  Linear”:

	Min threshold signalling colour	Colour selection for signalling MIN threshold. 18 colours palette available.
	OK threshold signalling colour	Colour selection for signalling OK threshold. 18 colours palette available.
	Max threshold signalling colour	Colour selection for signalling MAX threshold. 18 colours palette available.
	Min Max range background colour	Background colour selection for MIN, MAX range of the bargraph. 17 colours palette available.
	OK range signalling colour	Background colour selection for OK range of the bargraph. 18 colours palette available.
	Gradient	Enabling / Disabling filling effect "Gradient" type.

Means of operation:

The bar graph represents in a linear way the measuring range of a scale.



In addition, the bar graph can indicate weighing thresholds MIN, MAX, if they have been determined:

- Signalization of mass below the value set in MIN threshold:



- Signalization of mass within MIN and MAX values of thresholds:



- Signalization of mass exceeding the value set in MAX threshold:



17.4.5. "Control" bargraph

The "Control" bargraph is operated only in the working mode < CPG>.

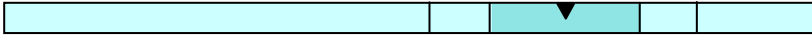

Means of operation:

The bargraph features signalization points of:

- Nominal mass **Qn** declared for a product,
- **MIN, MAX** thresholds – if such are declared,
- Mass value for **Qn-T**,
- Mass value for **Qn-2T**,
- Mass value for **Qn+T**,
- Mass value for **Qn+2T**.

Where:

Qn – nominal mass
T – T error
2T – double T error

- Signalling mass below set value of **Qn-2T**:

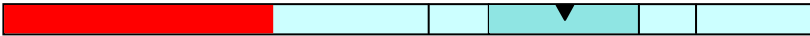

- Signalling mass between the values of **Qn-2T** and **Qn-T**:



- Signalling mass between the value of **Qn-T** and **Qn+T**:



The bargraph field between the above values gets automatically rescaled and it is additionally marked by a “**magnifier**” pictogram visible in graph’s left corner.

- Signalling mass between the value of **Qn+T** and **Qn-2T**:



- Signalling mass above the set value of Q_n+2T :



Caution:

In case of additional declaring the values for **MIN**, **MAX** limits, the “control” bargraph refers to the **MIN**, **MAX** limits and the nominal mass, but without displaying the errors for T and $2T$.



18. INPUTS / OUTPUTS

PUE 7.1 weighing indicator are equipped with 4 inputs / 4 outputs. To adjust software to the users needs configure inputs outputs in the submenu

in the submenu **Inputs / Outputs**:

- indicator inputs,
- indicator outputs.

In order to enter submenu **Inputs / Outputs**>, press **SETUP**

and then: „ **Inputs / Outputs**”.

18.1. Configuration of inputs

Procedure:

- Enter **Inputs / Outputs**> according to ch. 18 of this manual,
- Choose **Inputs**> and enter the selected input you will see a list of functions to ascribe,
- Choose the required function from the list and return to weighing saving the changes according to ch. 12.2 of this manual.



Caution:

The list of functions to ascribe to inputs are described in **APPENDIX B** of this manual. By default inputs have no ascribed functions **<None>**.

18.2. Configuration of outputs

Ascribing a function to the output enables the output at the same time. If an output has no ascribed function it is disabled.

Procedure:

- Enter <  **Inputs / Outputs** > according to ch. 18 of this manual,
- Choose <  **Outputs** > and enter the required output, then you will see the list of functions:

None	Output disabled
Stabile	Stable weighing result over LO threshold value
MIN stable	Stable weighing result below the MIN threshold
MIN non-stable	Non-stable weighing result below the MIN threshold
OK stable	Stable weighing result between MIN and MAX thresholds
OK non-stable	Non-stable weighing result between MIN and MAX thresholds
MAX stable	Stable weighing result over the MAX threshold
MAX non-stable	Non-stable weighing result over the MAX threshold
Zero	Stable weighing result zero net
Confirmation of cycle completion *	Signal that confirms that a cycle of dosing has been completed (the defined amount)
Zero	Zero weighing result („zero” indication)
! OK unstable	Unstable weighing result out of OK threshold
! OK stable	Stable weighing result within OK threshold
Measurement saved	Signal for measurement record confirmation - OUT programmed to be active for 500 [ms]
Tarring completed	Signal for tarring operation confirmation - OUT programmed to be active for 500 [ms]
Zeroing completed	Signal for zeroing operation confirmation - OUT programmed to be active for 500 [ms]
Error	Error message displayed
PGC – pending weighing process	Signal for awaiting for weighing performed within PGC control process

PGC – pending control	Signal for awaiting for PGC control
------------------------------	-------------------------------------

*) Not applicable to „**Standard**” software.

- Choose the required function from the list and return to weighing saving the changes according to ch. 12.2 of this manual.

Caution:

By default all outputs have no function attributed – setting <None>.

19. AUTHORIZATION

The submenu < **Authorization**> is accessible only while being logged in as the **Administrator**. In this group of parameters access levels can be outlined.



To enter submenu < **Authorization**>, press  and then:

„ **Authorization**”.

19.1. Anonymous Operator

The program allows to attribute the authorization access level to an operator who does not perform the log-in procedure (anonymous operator).

Procedure:

- Enter < **Authorization**> according to ch. 19 of this manual, choose < **Anonymous Operator**>, and then set the authorization access level.

Accessible authorization levels:



None, Operator, Advanced Operator, Administrator.

19.2. Date and time

Default settings allow a logged-in **Administrator** to change settings of date and time. Software however allows to change the access level to this option:

< **Date and time**>.

Procedure:

- Enter parameters' group < **Authorization**> according to ch. 19 of this manual, choose < **Date and time**>, and then set the parameter.

Accessible authorization levels:

None, Operator, Advanced Operator, Administrator.

Caution:

Setting <None> allows free access to settings of date and time (without the need of Logging in).

19.3. Printouts

Default settings of the scale allows a logged on **Administrator** to edit printout templates. Software allows to change the access level to option

< **Printouts**>.

Procedure:

- Enter parameter group < **Authorization**> according to ch. 19 of this manual, choose < **Printouts**>, and set appropriately.

Access levels to printouts that can be set:

None, Operator, Advanced Operator, Administrator.

Caution:

When you choose setting <None> printout templates can be changed even without Logging on.

19.4. Databases edition

It is possible to set the access levels to the following databases:

- Database of Products,
- Database of Clients,
- Database of Formulations,
- Database of Dosing processes,
- Database of Packages,
- Database of Warehouses,
- Database of Vehicles,
- Database of Labels,
- Database of Images,
- Database of Identification processes,
- Weighing counter,
- Delete older data.

Procedure:

- Enter parameters' group < **Authorization**> according to ch. 19 of this manual, choose < **Databases edition**>, and then set the parameter.



Accessible authorization levels:

None, Operator, Advanced Operator, Administrator.



Caution:

Setting <**None**> allows free access to settings of date and time (without the need of Logging in).

19.5. Delete older data

Scales default settings allow for cancellation of older data kept in < **Reports**> submenu. To do it the user must log in as an **Advanced Operator** (NOTE: the software allows for changing the access level to < **Delete older data**> option).

Procedure:

- Enter parameters' group < **Authorization**> according to ch. 19 of this manual, choose: „ **Databases edition** /  **Delete older data**”, and then set the parameter.

Accessible authorization levels:



None, Operator, Advanced Operator, Administrator.

19.6. Set element from the database

The user may set authorization levels for scales operator when it comes to selection of particular database positions by the operator:

- Products,
- Clients,
- Formulas,
- Dosing processes,
- Packaging,
- Warehouse,
- Vehicles,
- Identification processes,
- Lot number,
- Batch number.

Procedure:

- Enter parameters' group < **Access level**> according to ch. 19 of this manual, select < **Set element From the database**> and then set the appropriate option.

Accessible authorization levels:

None, Operator, Advanced Operator, Administrator.

Caution:



Setting <None> allows free access to selection of a particular database position (without the need of logging in).

19.7. CPG

The user may set authorization levels when it comes to modification of the following local parameters values of < CPG> operating mode:

- Batch number,
- Number of batches,
- Number of samples,
- Average tare estimation,
- Tare,
- Density.

Procedure:

- Enter parameters group < **Access level**>, according to ch. 19 of this manual, select < CPG> and then set a right option.

Accessible authorization levels:

None, Operator, Advanced Operator, Administrator.

20. UNITS

Scale, in submenu < **Units**> enables selecting:

- Declaring accessibility of the weighing units,
- Declaring the start unit,
- Determining two user defined units (custom units),
- Changing the value of g-cor (the value of gravitational acceleration force).

To enter submenu < **Units**>, press  and then: „ **Units**”.

20.1. Units accessibility

Submenu < **Accessibility**> enables declaring weighing units that should be accessible for selecting in the weighing window after pressing the weighing unit pictogram.

Procedure:

- Enter submenu $\langle \begin{matrix} [ct] \\ [lb] \\ [g] \end{matrix} \mathbf{Units} \rangle$ in accordance with ch. 20 of this user manual,
- Select option $\langle \begin{matrix} [ct] \\ [lb] \\ [g] \end{matrix} \mathbf{Accessibility} \rangle$ which opens a window with a list of available weighing units with their accessibility attribute.

Where:



- Weighing unit enabled



- Weighing unit disabled

- Set required accessibility criterion for the weighing units and exit to weighing mode.

20.2. Start unit

Procedure:

- Enter submenu $\langle \begin{matrix} [ct] \\ [lb] \\ [g] \end{matrix} \mathbf{Units} \rangle$ in accordance with ch. 20 of this user manual,
- Select option $\langle \begin{matrix} [ct] \\ [lb] \\ [g] \end{matrix} \mathbf{Start units} \rangle$ and choose a start unit from displayed list of available weighing units.

Possible selection:

- none
- gram [g]
- kilogram [kg]
- carat [ct]
- pound [lb]
- ounce [oz] *
- Newton [N] *

*) – weighing unit inaccessible in a verified scale



- Exit to main menu with procedure of saving changes,
- On restarting the scale, the instrument operates with enabled start unit.

20.3. User defined units

An option only for non-verified scale

Procedure:

- Enter submenu $\langle \begin{matrix} [ct] \\ [lb] \\ [g] \end{matrix} \text{Units} \rangle$ in accordance with ch. 20 of this user manual,
- Select option $\langle \begin{matrix} [g] \\ [ct] \end{matrix} \text{Defined unit 1} \rangle$ and determine the values of the following parameters:

 00285	Multiplier	Multiplier of scale's adjustment unit
	Name	Unit name (Max 3 characters)

- Exit to main menu with procedure of saving changes,
- Press symbol of the new weighing unit visible in the weighing window, which activates list of available weighing units with new custom unit added at the end of the list.

Caution:

The procedure of defining the second custom unit $\langle \begin{matrix} [g] \\ [ct] \end{matrix} \text{Defined unit 2} \rangle$ is equal to the procedure described above.





20.4. Acceleration of gravity

Parameter $\langle \begin{matrix} [g] \\ [ct] \end{matrix} \text{Acceleration of gravity} \rangle$ eliminates the changes of gravitational acceleration force at different latitudes and altitudes in case of weighing process with application of "Newton" [N] weighing unit.

Procedure:



- Enter submenu $\langle \begin{matrix} [ct] \\ [lb] \\ [g] \end{matrix} \text{Units} \rangle$ in accordance with ch. 20 of this user manual,
- Select option $\langle \begin{matrix} [g] \\ [ct] \end{matrix} \text{Acceleration of gravity} \rangle$ which opens an editing window $\langle \text{Acceleration of gravity} \rangle$ with a numeric keyboard,
- Insert the new value of acceleration of gravity for the place of use and accept it by pressing  key,
- Exit to main menu.

21. OTHER PARAMETERS

There is a group of parameters different from others which influence the operation of the scale. They are gathered in group  **Others** e.g. language, beep etc. To enter  **Others**, press  and then:  **Others**".

21.1. Languages

Procedure:





- Enter submenu  **Others** according to ch. 21 of this manual, choose  **Language** and set the parameter.

Accessible languages:

- Polish, English, German, French, Russian, Spanish, Czech, Hungarian, Estonian, Latvian, Italian, Greek, Turkish, Thai, China, Roman.



21.2. Setting date and time



Users can set date and time that are visible in the main window of the display. Entering the edit window of date and time can be made in two ways:

- Pressing the field „**date and time**” in the top bar of the main screen,
- Enter: „ /  **Others** /  **Date and Time** /  **Set date and time**” submenu.

After entering the setting of date and time the screen keyboard appears.

Set year, month, day, hour, minutes and confirm by pressing .

„ /  **Others** /  **Date and Time**” submenu contains additional functions that serve for defining date and time format:

Icon	Name	Value	Description
	Date format	yyyy.MM.dd *	Selection of date format. Possible values: d.M.yy, d.M.yyyy, d/M/yy, dd.MM.yy, dd.MM.yyyy, dd.MMM.yyyy, dd/MM/yy, dd/MM/yyyy, dd-MMM-yy, dd-MM-yy, M/d/yy, M/d/yyyy, MM/dd/yy, MM/dd/yyyy, yy/MM/dd, yy-M-dd, yy-MM-dd, yyyy.MM.dd, yyyy-M-dd, yyyy-MM-dd.
	Time format	HH:mm:ss **	Selection of time format. Possible values: H.mm.ss, H:mm:ss, H-mm-ss, HH.mm.ss, HH:mm:ss, HH-mm-ss, H.mm.ss tt, H:mm:ss tt, H-mm-ss tt, HH.mm.ss tt, HH:mm:ss tt, HH-mm-ss tt, h.mm.ss tt, h:mm:ss tt, h-mm-ss tt, hh.mm.ss tt, hh:mm:ss tt, hh-mm-ss tt
	2013.03.29	14:32:09	Date and time preview, declared formats taken into account.

*) – For date format: y – year, M – month, d – day



***) – For time format: H – hour, m – minute, s – second

Caution:

Parameter  **Date and Time** is accessible in the scale menu depending on the authorization access level set in the related parameter.

21.3. Sound signal

Procedure:

- Enter  **Others** according to ch. 21 of this manual,  **Beep** and set accordingly.



Settings:

- None** - Sound for buttons and proximity sensors disabled
- Buttons** - Sound for buttons enabled
- Sensors** - Sound for proximity sensors enabled
- All** - Sound for buttons and proximity sensors enabled

21.4. Screen volume

The user can control volume level being an effect of touching the screen, the volume can be modified within **0% - 100%** range. Default value of the volume level is **0%**.

Procedure:

- Enter  **Others**> submenu as described in chapter 21 of this manual,
- Select  **Screen volume**> parameter, **<Screen volume>** editing window with an on screen keyboard is displayed,
- Enter required volume level value in [%] and press  button to confirm.



21.5. Screen brightness

Scale user can change brightness of the screen in the range between **0%** and **100%**.

Caution:

*The default screen brightness is set to **90%**.*



Procedure:

- Enter submenu  **Other**> as described in chapter 21 of this manual,
- Select  **Screen brightness**> parameter, **<Screen brightness>** editing window with an on screen keyboard is displayed,
- Enter required screen brightness value in [%] and press  button to confirm.

21.6. Touch panel calibration

Touch panel calibration is required when inappropriate operation is recognized. E.g. the reaction in a different place than the touching point.



Procedure:

- Enter submenu  **Others**> according to ch. 21 of this manual,
- Select  **Touch Screen Calibration**> and then an editing field appears,
- Using a thin and soft pointer press (keep pressed for some time) in the point where the cross appears, after indicating the 4th place confirm changes by pressing .

21.7. Energy saving mode

The user can activate energy saving mode.

Procedure:

- Enter submenu  **Others**> according to ch. 21 of this manual, select  **Energy saving mode**> parameter and set appropriate option.

Where:

- | | |
|-----------------------|-----------------------------------|
| None | - Energy saving mode off |
| Screen dimming | - Changing screen brightness |
| Screensaver | - Activating screen blanking mode |
| Slideshow | - Activating slideshow mode |

Caution:



Active screen saving mode is conditioned by:

- Active  **Screen timeout**> parameter (read chapter 21.8 of this manual),
- Home screen of the scale displayed,
- Zero indication.

21.8. Screen timeout

The user can specify how much time it shall take before sleep mode activates. By default the value is set to **0[s]** (parameter inactive).



Procedure:

- Enter submenu  **Others**> according to ch. 21 of this manual,
- Select  **Screen timeout**> submenu, **<Screen timeout>** editing window with an on screen keyboard is displayed,
- Enter required time value in [s] and press  button to confirm.

21.9. Proximity sensor

The user can specify sensitivity for proximity sensors operation (sensors operation dependant on distance between the sensor and operator's hand).

Procedure:

- Enter submenu  **Others**> according to ch. 21 of this manual, select  **Proximity sensor**> parameter and set appropriate option.



Where:

- 0** - Sensors operation disabled
- 1 ÷ 9** - Sensitivity values range (the higher value, the broader sensors response range)



21.10. Logging in required

 **Logging in required**> parameter must be active if a logging operation is to be carried out by an operator after the device have been turned on.

Procedure:

- Enter submenu  **Others**> according to ch. 21 of this manual, select  **Logging in required**> parameter and then set the appropriate option.





Where:

-  - Inactive logging required
-  - Active logging required

21.11. Start logo

Submenu  **Start logo** allows to substitute a “start” graphic file of a scale with another one located on a memory stick.

Procedure:

- Put a memory stick into USB port of a scale,
- Enter submenu: „ **Others /  Start logo**” according to ch. 21 of this manual,
- Enter  **Start logo** to open content of a memory stick main folder,
- Chose the desirable graphic file and wait until scales program automatically returns to the  **Start logo** submenu. Chosen graphic will be displayed.

 **Set Default** option enables the user to get back to the default „**Start logo**”.



Caution:

Maintained file formats are *.jpg, *.png, with optimal (max.) resolution of 640x480 pixels.

21.12. Error information preview time

Submenu  **Error information preview time** enables user to declare for how long information about errors is to be displayed.

Procedure:

- Enter submenu  **Others** according to ch. 21 of this manual, select parameter  **Error information preview time** and set the appropriate option.

Where:

- 1 [s] - Displaying an information about errors for 1 [s]
- 3 [s] - Displaying an information about errors for 3 [s]
- 5 [s] - Displaying an information about errors for 5 [s]

- 10 [s] - Displaying an information about errors for 10 [s]
- Max - Displaying an information about errors until it has been confirmed with  button.



21.13. Export / import of settings

The user can export/import scale settings (printout templates, user parameters) using flash memory stick.

Procedure for settings export:

- Connect flash memory stick to USB port of your scale,
- Enter „ **Others** /  **Export**” submenu, settings are exported automatically to flash memory stick plugged to scale USB port.
- Upon completed procedure the following message is displayed: „**Operation completed successfully**”.



Procedure for settings import:

- Connect flash memory stick to USB port of your scale,
- Enter „ **Others** /  **Import**” submenu, settings are imported automatically from flash memory stick plugged to scale USB port.
- Upon completed procedure the following message is displayed: „**Operation completed successfully**”.



22. USER ADJUSTMENT

An option only for non-verified scale

Scales require to recalculate internal divisions to more suitable ones (e.g. g, kg etc.). In order to do this they require an adjustment factor. It is adjusted during the adjustment procedure using a mass standard. Adjustment should be carried out if weighing a standard mass shows a different mass value.

To enter < **User Adjustment**>, press  key and then: „ **User Adjustment**”.

22.1. Adjusting procedure

- Enter submenu  **User Adjustment** > according to ch. 22 and select: “ **Adjustment**”,
- After entering the parameter the following message box appears:



- Take the load off the pan of platform 1,
- Press button . The following message appears during adjusting start mass: „**Evaluation of starting mass**”,
- After the procedure has been completed the following message box appears:

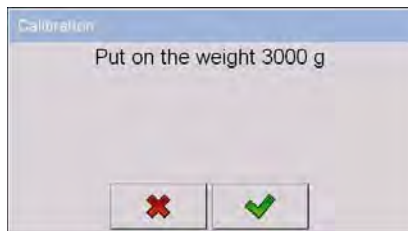

- Place determined mass on pan of platform 1 and then select ,
- After the procedure of adjustment factor determination following command appears:

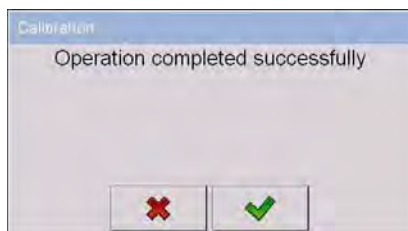

- Accept the message box by pressing  key and return to weighing mode.



<  **Setting of start mass** > parameter allows to adjust start mass of platform 1.



Caution:

The factory adjustment process for platforms 2, 3, 4 is analogical to the one described above.

22.2. Start mass adjustment

It is possible to adjust only a start mass, it helps to correct the start zero when the span does not change.

Procedure:

- Enter submenu <  **User Adjustment** > according to ch. 22 and select: “ **Setting of start mass**”,
- After entering the parameter the following message box appears:

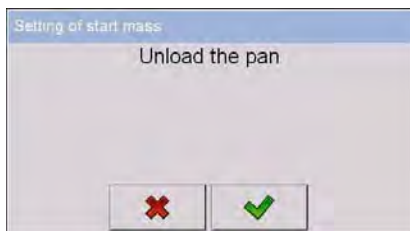

- Take the load off the pan of platform 1,
- Press button . The following message appears during adjusting start mass: „**Evaluation of starting mass**”,

- After the procedure has been completed the following message box appears:





- Accept the message box by pressing  key and return to weighing mode.



22.3. Report from adjustment process

Parameter <  **Report printout**> enables activating the function of automatic printout of a report from adjustment process on a printer plugged to the scale.

Procedure:

- Enter submenu <  **User Adjustment**> in accordance with ch. 22 of this user manual, select parameter <  **Report printout**> and set its appropriate value.

Where:

-  - Automatic report printout switched off
-  - Automatic report printout switched on





Caution:

Submenu: “  **Devices** /  **Printer** /  **Printouts**





/  **Adjustment report Printout template**” enables optional modification of report template (see ch. 16.2.3 of this user manual).

22.4. Adjustment track record

Each completed adjustment process is automatically saved in scale's database in submenu  **Adjustment track record**.

In order to enter submenu  **Adjustment track record** >, press  key, and: „ **User Adjustment** /  **Adjustment track record**”. Files comprising reports have names with time and date when the process was performed.



List of data for a carried out adjustment process:

	Date	Data of carried out operation
	Operator	Operator name
	Nominal Mass	Mass of adjustment weight
	Platform number	Platform number on which an operation was performed

The user can print data on a specific entry by pressing  key, located in the top bar of software's window.



23. SOFTWARE UPDATE

A user of the scale can carry out ON-LINE updating of the software version using Ethernet network or an external data storage device connectable to the USB port of the terminal.



Enter the submenu  **Update**> by pressing  key, and next press: “ **Update**”.

23.1. ON-LINE updating

Caution:

1. **ON-LINE** updating requires access to a global **INTRANET** network.
2. Before updating the software, go to scale's submenu:
“ **Communication** /  **Ethernet**” and set transmission parameters for compatible with the client's local network.

Procedure:

- Enter submenu <  **Update**> in accordance with point 23 of this user manual,
- Select parameter <  **Software version on server**> which reads software version and its availability date on RADWAG server.

Caution:

In case of no connection with the global network **Intranet** or incorrect settings of Ethernet parameters, the scale displays the following message: “ **No connection**”.

- Go to parameter <  **Update From server**> which displays the following message:



- Accept the message by pressing  key which is followed by displaying the updating progress window:

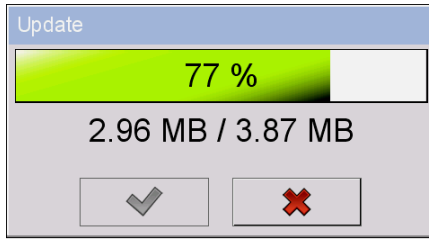

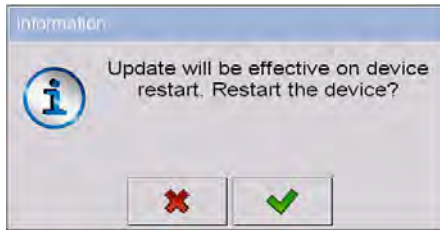

- After downloading the update press an active  key which is followed by displaying a message:



- Accept the message by pressing  key. The terminal shall restart with update installing procedure.

23.2. Update from pen drive

Procedure:

- Copy file “**update.pue71**” containing the current software version onto the external data storage device (to the main catalogue),
- Connect the data storage device to terminal's USB port,
- Go to submenu  **Update**> in accordance with point 23 of this user manual,
- Go to parameter  **Update From pen drive**> which displays the following message: “**Update?**”,

Caution:

*In case the data storage device is not connected to the terminal's USB port and/or there is no „**update.pue71**” file in the main catalogue of the pen drive, the software displays the following message “**Update error**”.*

- Accept the message by pressing  key which automatically starts the updating process. On its completion the terminal displays the following message:

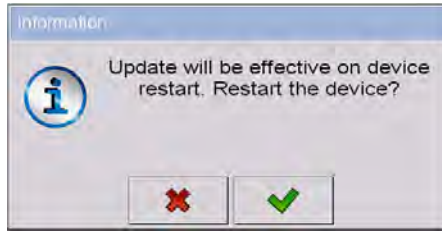

- Accept the message by pressing  key. The terminal shall restart with update installing procedure.

23.3. Changes in software

Parameter  **<Changes in software>** enables acquiring data on changes present in the updated software version.

Procedure:

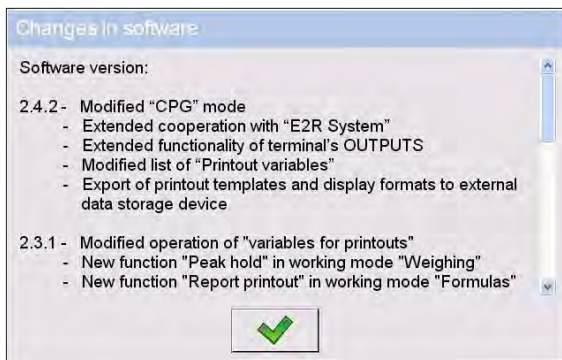

On completing the software updating procedure go to parameter

 **<Changes in software>** which opens an information window **<Changes in software>**:



24. SPECIAL FUNCTIONS OF WORKING MODES

Scale can operate in following work modes:

	Weighing
	Counting pieces
	Deviations
	Dosing
	Formulation
	CPG
	Density
	Weighing animals
	Vehicle scale

Work modes can be configured in  **Working Modes**>.

To enter submenu  **Working Modes**>, press  and then:
„ **Working Modes**”.

The settings of specific working modes provide access to special functions adjusting operation of the instruments to client's individual needs.

Caution:

1. First left screen button  (local settings) in the main window of every working mode is ascribed to access settings of current mode.
2. The change in on mode results in the same change for other working modes working modes.

Part of the special functions have global effect, i.e. they are applicable to most of accessible working modes (except for working modes: Formulation, Dosing, Vehicle scale), as presented on below table:



	Weighing	Parts counting	Percent setup	Weighing animals	Density	CPG
Save Mode	+	+	+	-	+	+
Down-weighing	+	+	+	-	-	-
Checkweighing	+	+	+	+	+	-
Tare mode	+	+	+	+	+	-
Labelling mode	+	+	+	+	-	-
Statistics	+	+	+	+	+	+
Differential weighing	+	-	-	-	-	-
Min 2, Max 2 thresholds active	+	-	-	-	-	-
Peak hold	+	-	-	-	-	-
Information about saved measurement	+	+	+	-	-	+
Ingredient weight entered manually	+	+	+	-	-	-

Other special functions are related directly to a specific working mode, and they are described in further part of this user manual.



24.1. Working modes accessibility

Submenu  **Accessibility** enables declaring presence of scale's working modes in the user menu after pressing a pictogram with a working mode located in the left corner of the top bar in the main window.

Procedure:

- Enter group of parameters  **Working modes** in accordance with point 24 of the user manual,
- Select option  **Accessibility** which opens a list with available working modes and their accessibility attribute.

Where:



-  - Working mode enabled
-  - Working mode disabled

- Set accessibility attribute for each of the working modes and return to weighing mode.

24.2. Save mode

Depending on setting parameter  **Save Mode** users can send data from the scale to an external device.

Procedure:

- Enter parameters group  **Working modes** according to ch. 24 of this manual,
- Enter the required mode and choose  **Save Mode** then choose the required mode.



Accessible options:

Manual every stable	- Manual printout of each stable weighing result for mass measurement over -LO- threshold
Manual first stable	- Manual printout of the first stable weighing result for mass measurement over -LO- threshold
Automatic first stable	- Automatic printout of the first stable weighing result for mass measurement over -LO- threshold
Automatic last stable	- Automatic printout of the last stable weighing result for mass measurement below -LO- threshold
Semi-automatic every stable	- Manual printout of each weighing result for mass measurement over -LO- threshold – awaiting for a stable result
Semi-automatic first stable	- Manual printout of the first weighing for mass measurement over -LO- threshold – awaiting for a stable result

24.3. Down-weighing

Software allows to weigh in the “down-weighing” mode. It consist in putting the load on the pan and taking off/removing portions of it with concurrent saving weighments equal to the portions taken off the pan.

Procedure:

- Enter parameters group <  **Working Modes**> according to ch. 24 of this manual,
- Enter the required working mode and choose <  **Down-weighing**> and then set the required option.

Accessible options:





- Traditional weighing
- Down-weighing mode

24.4. Checkweighing

In case of enabling the checkweighing mode, printouts are performed only when a weighing is between **MIN** and **MAX** thresholds that have been defined before.

Procedure:

- Enter parameters group <  **Working Modes**> according to ch. 24 of this manual,
- Enter the required working mode and choose <  **Checkweighing**> then set the required option.

Options:



- Every weighing is recorded
- Only weighments between MIN, MAX are recorded.

24.5. Tare mode

This function enables users to set parameters for tarring.

Procedure:

- Enter parameters group <  **Working Modes**> according to ch. 24 of this manual,

- Enter the required working mode and choose  **Tare mode** and then set the required option.

Options:

- | | |
|-------------------------|-------------------------------------------------------------------------------------------------------------------------------------------------------------------------|
| Single | - Basic tare mode. The set (chosen) tare value is overwritten after entering a new value |
| Current sum | - Summing up tare values of product and package together with manually inscribed tare. After next setting of product or package tare the entered tare value is disabled |
| Total sum | - Summing up all subsequently entered tare values |
| Autotare | - Automatic tare mode together with mode <Sum of all> |
| Each measurement | - Automatic tarring for each accepted measurement result. |

24.6. Labelling mode

Labelling mode can be initiated together with every working mode. The labelling system is intended to print labels for marking weighed goods e.g. a packing process. The program can print standard labels for single products, cumulative labels for sticking to bulk containers and cumulative labels for sticking to the large transport containers holding bulk containers.

In submenu  **Labelling mode** there are accessible following special functions:



Number of labels



No. of cumulative labels



No. of CC labels



C label automatic triggering







CC label automatic triggering

24.6.1. Setting of the number of labels to print

In the parameter <  **Number of labels**> user defines the amount of labels. They are printed on the printer connected to the weight.





Procedure:

- Enter parameters group <  **Working Modes**> according to ch. 24 of this manual,
- Enter the required working mode and choose: „  **Labelling mode /  **Number of labels****” then the editing field <**Number of labels**> with the screen keyboard is opened,
- Choose the required number of labels and confirm by pressing .

24.6.2. Setting of the number of cumulative labels to print

In the parameter <  **No. of cumulative labels**> define the amount of sum labels. They are printed on connected printer.





Procedure:

- Enter parameters group <  **Working Modes**> according to ch. 24 of this manual,
- Enter the required working mode and choose: „  **Labelling mode /  **No. of cumulative labels****”, then the editing field <**No. of cumulative labels**> with the screen keyboard is opened,
- Enter the required number of cumulative labels and confirm by pressing .



24.6.3. Setting of the number of CC labels to print

In the parameter <  **No. of CC labels**> define the amount of total sum labels to print. They are printed on connected printer.





Procedure:

- Enter parameters group  **Working Modes** according to ch. 24 of this manual,
- Enter the required working mode and choose: „  **Labelling mode /**  **No. of CC labels**”, then the editing field **<No. of CC labels>** with the screen keyboard is opened,
- Enter the required number of cumulative labels and confirm by pressing .

24.6.4. Automatic triggering of cumulative labels

Users have access to the function of automatic triggering of printing cumulative labels after setting parameters **<**  **Mode** **>** and **<**  **Threshold** **>**.

Procedure:

- Enter **<**  **Working modes** **>** parameter group as described in chapter 24 of this manual,
- Enter the required working mode and choose: „  **Labelling mode /**  **C label automatic triggering /**  **Mode**” and then set the required option:

None - Cumulative label printout is initiated by pressing



Mass - Cumulative label printout is initiated by exceeding the value set in parameter **<**  **Threshold** **>**. The value is treated as the total from single weighments,

Number - Cumulative label printout is initiated by exceeding the value set in parameter **<**  **Threshold** **>**. The value is treated as the number of single weighment.



*) Manual printing of cumulative labels can be done in two ways depending on the button used:



Printing followed by zeroing label counter or the total mass







Printing without zeroing label counter or the total mass

By default setting button  is accessible in the bottom part of the display but activating the button  can be done in submenu:



„**SETUP** /  **Display** /  **Actions**”
(see ch. 17.2 of this manual).

For automatic printout of cumulative labels counters and total mass variables are always zeroed.

- Confirm the changes by pressing  and go to parameter  **Threshold** then **Threshold** window appears with the screen keyboard,
- Set the appropriate value for automatic triggering cumulative labels:
 - If parameter  **Mode** is set to **Mass** then enter the required value of total mass to exceed in order to print the C label,
 - If parameter  **Mode** is set to **Number** use the screen keyboard to enter the required counter value as a threshold to trigger off printing C labels.
- Confirm the changes introduced by pressing .



24.6.5. Automatic triggering cumulative labels of cumulative labels



Users have access to the function of automatic triggering of printing cumulative labels of cumulative labels after setting parameters

 **Mode** and  **Threshold**.

Procedure:

- Enter  **Working modes** parameter group as described in chapter 24 of this manual,

- Enter the required working mode and choose: „ **Labelling mode /**
 **CC label automatic triggering /**  **Mode”** and then set the required option:

None - Cumulative label of cumulative labels printout is initiated by pressing  or  ,

Mass - Cumulative label of cumulative labels printout is initiated by exceeding the value set in parameter  **<Threshold>**. The value is treated as the total from single weighments,

Number - Cumulative label of cumulative labels printout is initiated by exceeding the value set in parameter  **<Threshold>**. The value is treated as the number of single weighments,



- *) Manual printing of cumulative labels can be done in two ways depending on the button used:



Printing followed by zeroing label counter or the total mass







Printing without zeroing label counter or the total mass

By default setting button  is accessible in the bottom part of the display but activating the button  can be done in submenu:

„ /  **Display /**  **Actions”** (see ch. 17.2).

For automatic printout cumulative labels of cumulative (CC) labels counters and total mass variables are always zeroed.



- Confirm the changes by pressing  and go to parameter  **<Threshold>** then **<Threshold>** window appears with the screen keyboard,
- Set the appropriate value for automatic triggering CC labels:
 - If parameter  **<Mode>** is set to **<Mass>** then enter the required value of total mass to exceed in order to print the CC label,

- If parameter  **Mode** is set to **<Number>** use the screen keyboard to enter the required counter value as a threshold to trigger off printing CC labels.
- Confirm the changes introduced by pressing .

24.7. Statistics

All statistics are continuously updated after each measurement is saved in the scale memory. Statistics can be calculated globally (does not depend on the selected product) or separately for every product from the product database. It can be set in parameters  **Statistics**.

Procedure:

- Enter  **Working modes** parameter group as described in chapter 24 of this manual,
- Enter the required working mode and choose  **Statistics** and then set the required option.

Options:

- Global** - global statistics,
- Product** - statistics for every product.





Caution:







*In case of operation with  **Statistics** set to **<Product>** bear in mind that after restarting, only statistics of the last weighed product are recovered.*

24.8. Differential weighing

Function  **Differential weighing** enables analysing mass changes of one or more samples. To do it start mass of a sample must be estimated, next the sample undergoes various processes during which some components of the sample are subtracted or added. Finally the sample is weighed again (differential weighing). The scales calculates the difference between two mass values (weighment I and weighment II).

24.8.1. Local settings

Local settings for  **Differential weighing** function are to be accessed in submenu: „  **Working modes** /  **Weighing** /  **Differential weighing**:

	Activation	Activation of differential weighing function ( - function active,  - function inactive)
	Batch portion type	Batch type, for differential weighing: Value – differential weighing is realized according to declared as measuring series batch value. Filter – differential weighing is realized according to filter and batch value declared as a measuring series value.
	Filtering	Filter type declaration, differential weighing is realized according to this filter. Values: Product, Client, lot number, batch number, source warehouse, target warehouse, packaging. Parameter <Filtering> is not accessed if <Batch portion type> parameter value is set to <Value> .
	Charge	Measuring series value for differential weighing

24.8.2. Reporting realized processes of differential weighing

Report of each realized process of differential weighing is saved to database

 **Differential weighments reports**, date and hour of an executed process is the file name. To view list of data for a process of differential weighing see point 35.5.8 of this manual.

24.9. Peak hold



The scale enables measuring the maximum force influencing the weighing pan.

Procedure:

- Enter  **Working modes** parameter group as described in chapter 24 of this manual,

- Enter the required working mode and choose  **Peak hold** and then set the required option.



Where:

-  - Scale operates in standard weighing mode
-  - Scale operates with mode forcing lock of maximum indication on the display, i.e. peak hold.
- On loading the weighing pan with changeable force, the displays locks the indication of the maximum measured force. The locked value is signalled by red colour of the displayed value.
- Remove load from the weighing pan.
- Before carrying out the following measurement press  button.

24.10. Information about saved measurement

The user can activate message informing on the fact that a particular weighing result has been recorded in a database, the message is displayed each time after performed measurement.

Procedure:

- Enter submenu  **Working modes** according to ch. 24 of this manual,
- Enter „**Weighing**” mode and activate option:  **Information about saved measurement**,
- Each time after completed measurement the message **<Measurement saved>** is displayed.

Caution:



*The message is displayed as long as value of  **Error information preview time** parameter specifies (read point 21.12 of this manual).*

24.11. Packaging quantity query

The user can use packaging weight multiplier function. To do it parameter:

< **Ingredient weight entered manually**> must be activated.

Procedure:

- Enter submenu < **Working modes**> according to ch. 24 of this manual
- Enter „**Weighing**” mode and activate option: < **Ingredient weight entered manually**>,
- Each time the user selects record of particular packaging stored within a database of packages, <**Enter no. of packages**> window with an on screen keyboard is displayed,
- Upon entering particular packaging quantity value, weight value equal to declared multiplied value of packaging is displayed along with **Net** and  symbols.



25. WORKING MODE - WEIGHING

The < **Weighing**> mode is the standard working mode allowing to perform weighments and saving them in the database

< **Weighings / Alibi**>.











25.1. Starting the working mode

The < **Weighing**> mode is the standard working mode. If a user has changed the operating mode to another follow the actions below:

- While in the main window press the icon with mode name placed on the top bar on the left then submenu comprising all accessible working modes <**Working Modes**> opens,
- Choose < **Weighing**>, program automatically returns to the main window displaying icon  in the top bar.

25.2. Local setting of a working mode

Local setting of a working mode  **<Weighing>** are accessible on pressing a hot key  **<Local parameters>**:

	Save Mode	Detailed description in ch. 24.2 of the user manual
	Down-weighing	Detailed description in ch. 24.3 of the user manual
	Checkweighing	Detailed description in ch. 24.4 of the user manual
	Tare mode	Detailed description in ch. 24.5 of the user manual
	Labelling mode	Detailed description in ch. 24.6 of the user manual
	Statistics	Detailed description in ch. 24.7 of the user manual
	Differential weighing	Detailed description in ch. 24.8 of the user manual
	Peak hold	Detailed description in ch. 24.9 of the user manual
	Information about saved measurement	Detailed description in ch. 24.10 of the user manual
	Ingredient weight entered manually	Detailed description in ch. 24.11 of the user manual

26. WORKING MODES – PARTS COUNTING

Parts counting is working mode allowing to count pieces on the basis of the standard unit mass of a single piece set on the scale or fetched from the database.



Caution:

If parts counting is performed in an additional container it should be tarred.

26.1. Starting the working mode

Procedure:

- While in the main window press  in the top bar, then you will see a submenu **<Working Modes>** comprising a list of modes,

- Choose  **Parts counting** >, program automatically returns to the main window displaying icon  in the top bar,
- The weight unit is automatically changed to „**pcs**” and two screen buttons on the right side appear:













Enter part mass



Estimate part mass

26.2. Local settings of the working mode

Local settings of the working mode  **Parts counting** > are accessible on pressing a hot key  **Local parameters**:

	Automatic correction of reference mass	Detailed description in ch. 25.2.1 of the user manual
	Minimum reference mass	Detailed description in ch. 25.2.2 of the user manual
	Save Mode	Detailed description in ch. 24.2 of the user manual
	Down-weighing	Detailed description in ch. 24.3 of the user manual
	Checkweighing	Detailed description in ch. 24.4 of the user manual
	Tare mode	Detailed description in ch. 24.5 of the user manual
	Labelling mode	Detailed description in ch. 24.6 of the user manual
	Statistics	Detailed description in ch. 24.7 of the user manual
	Information about saved measurement	Detailed description in ch. 24.10 of the user manual
	Ingredient weight entered manually	Detailed description in ch. 24.11 of the user manual

26.2.1. Automatic correction of reference mass



It concerns the  Parts counting> working mode



Working mode  **Parts counting**> comprises a special function

 **Automatic correction of reference mass**>, that can be used for correcting the unit mass <SMP>. To enable the function in parameters you need to:

- Enter parameter group  **Working modes**> according to ch. 24 of this manual, choose: „ **Parts counting** /  **Automatic correction of reference mass**” and set appropriate option.

Options:

-  - Automatic correction of reference mass disabled
-  - Automatic correction of reference mass enabled



Function  **Automatic correction of reference mass**> in mode  **Parts counting** > is enabled at the moment of estimating the sample quantity and signalled by displaying <PCS> and <SMP> (single part/piece mass) on the top part of the display.

There are four criteria of working “Automatic correction of reference mass” function:

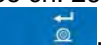
1. equilibrium should be reached,
2. quantity of parts/pieces should be increased,
3. added quantity of parts/pieces should not be greater than double number of parts/pieces on the pan,
4. the new sample can be different from the old sample by ± 0.3 of pcs (absolute value),

If a user recognises that the sample quantity is adequate the unit mass (single piece mass) can be saved (see ch. 26.6 of this manual) and disable the function by pressing .

Caution:

While the parts counting function is active the functionality of  button is changed. Pressing  does not result in printing and saving weighments.

26.2.2. Minimum reference mass

It concerns the  **Parts counting** > working mode

Users before beginning the procedure of single piece mass evaluation can declare “**minimum reference mass**” i.e. minimum total weight of all pieces put on the scale pan expressed in reading divisions.

Procedure:

- Enter parameter group <  **Working modes** > according to ch. 24 of this manual,
- Choose „ **Parts counting** /  **MIN** **Minimum reference mass**” and then set an appropriate value.

Accessible settings: 1 d, 2 d, 5 d, 10 d.





Caution:

While the procedure of evaluation the mass of single piece the mass of all pieces put on the pan is lower than the value declared in parameter

„ **MIN** **Minimum reference mass**”, the following warning message will be displayed: < **Too low sample mass** >.

26.3. Setting a reference unit by entering known piece mass

Procedure:







- Enter mode <  **Parts counting** > according to ch. 26.1 of this manual,
- Press  (enter piece mass), then an editing field is displayed <**Reference Unit**> with the screen keyboard,
- Enter a value and confirm it by pressing , which causes starting <  **Parts counting** > with automatic setting the reference unit.

Caution:

1. In case of entering a reference unit higher than the maximum weighing range of the main scale the program will display a message box: **<Value too high>**,
2. In case of entering the single piece mass lower than 0.1 d, the program will display a message box: **<Value too small>**.

26.4. Setting a reference unit by weighing a sample

Procedure:

- Enter mode  **Parts counting** according to ch. 26.1 of this manual,
- If pieces are weighed in a container it needs to be put on the pan and tared,
- Press  (estimate piece mass), then the editing field is displayed **<Reference Quantity>** together with the screen keyboard,
- Enter a value and confirm it by pressing , then the following message is displayed: **<Put pieces: xx>** (where **xx** – the value entered before),
- Put the declared quantity of pieces on the pan and when the result is stable (symbol ) confirm it by pressing .
- The program automatically calculates reference unit mass and causes starting  **Parts counting** >.





Caution:

- *The total mass of all pieces put on the weight pan cannot be greater than the weighing range;*
- *The total mass of all pieces put on the weight pan cannot be less than the value declared in parameter „**Minimum reference mass**” (see section 26.2.2). If the condition above is not fulfilled the scale displays the message **<Too low sample mass>**;*
- *The mass of one unit may not be less than **0.1 of reading division** of the scale. If this condition is not fulfilled the scale displays the message: **<Too low piece mass>**.*

26.5. Setting the reference mass by entering single piece mass directly to the database

After selecting a product from the product database a mass of single piece from the field **<Mass>** is used.

Procedure:

- While in  **Parts counting** > press ,
- Using  or  choose a product and confirm it by pressing .

Caution:

The selected product has to have declared unit mass (single piece mass).

26.6. Inscribing the unit mass to the database

The unit mass can be described a unit mass the following way:

- Estimate the unit mass (see 26.2 and 26.3),
- Enter the products database ,
- Keep the finger pressed on the required position then a context menu is displayed,
- Choose option **<Ascribe standard>**, then the standard unit mass is attributed to the product in the field **<Mass>**.

Caution:



*Attributing a standard to a selected product is also possible by programmable button. Setting programmable buttons is described in ch. 17.2 of this manual The list of functions is described in **APPENDIX B** of this manual.*

27. WORKING MODES – PERCENT SETUP (DEVIATIONS)

The program allows to check weighments in deviations (in %) around an outlined standard mass. The standard mass can be outlined by weighing or entering it by a user.

27.1. Starting the operating mode

Procedure:

- While in the main window press  in the top bar of the window then you will see a submenu **<Working Modes>** comprising a list of modes,
- Choose mode **< Deviations>**, the program will automatically returns to the main window displaying icon  in the top bar,
- The weight unit is automatically changed to „%” and two screen buttons on the right side appear:





Enter reference mass











Estimate reference mass







27.2. Local settings of the working mode

Local settings of the working mode **< Deviations>** are accessible on pressing a hot key **< Local parameters>**:

	Save Mode	Detailed description in ch. 24.2 of the user manual
	Down-weighing	Detailed description in ch. 24.3 of the user manual
	Checkweighing	Detailed description in ch. 24.4 of the user manual
	Tare mode	Detailed description in ch. 24.5 of the user manual
	Labelling mode	Detailed description in ch. 24.6 of the user manual
	Statistics	Detailed description in ch. 24.7 of the user manual
	Information about saved measurement	Detailed description in ch. 24.10 of the user manual
	Ingredient weight entered manually	Detailed description in ch. 24.11 of the user manual



27.3. Reference unit mass estimated by weight

Procedure:

- Enter  **Deviations**> according to ch. 27.1 of this manual,
- If the standard is to be weighed in a container, the container needs to be put on the pan and tarred,
- Press  (Estimate standard mass), then a message is displayed: **<Put standard>**,
- Put the load on the pan. After stabilization the result is taken as a standard (symbol ). Confirm it by pressing ,
- At the same time the weight unit is changed to (w %).

27.4. Reference unit mass inscribing into the memory

Procedure:



- Enter  **Deviations**> according to ch. 27.1 of this manual,
- Press  (Give piece mass), then an editing field is displayed **<Give piece mass>** together with the screen keyboard,
- Enter a value and confirm by pressing ,
- At the same time the weight unit is changed to (w %).



28. WORKING MODES - DOSING

 **Dosing**> mode enables carrying out filling and dosing processes of goods on scales featuring a scales of Y series. The working mode enables manual and automatic dosing on a single or simultaneously on many weighing platforms.

28.1. Starting the working mode



Procedure:

- While in main window of the software, press  on-screen key, located in the top bar of the window, which opens submenu **<Working Modes>** containing the list of available working modes,
- Select working mode **<  Dosing>**, the software automatically returns to displaying the main window, and the top bar indicates the pictogram of a selected working mode ,
- Automatically the following on-screen key are enabled:

	Local parameters
	Select dosing process
	Start dosing process
	Stop dosing process
	Emergency stop



28.2. Dosing process structure

All activities related to the dosing process can be carried out from the level of scale. Each dosing process **<  >** contains:

- Its name **<  >**,
- code **<  >**,
- assigned weighing platforms **<  >** defined on a terminal.



Each of the weighing platforms can have its specific dosing process. The database of dosing processes has the same searching mechanisms for a specific record in a database as other terminal databases.











A dosing process can be searched in a database by:

- the name of a dosing process <  >
- the code of a dosing process <  >

Processes carried out on different weighing platforms operated by the same terminal, can also be dependent on each other, e.g.: dosing on weighing platform 2 can be initiated only on completing dosing on weighing platform 1, which is confirmed by a signal from appropriate sensor.

28.3. Local setting of a working mode













Local settings for the working mode <  **Dosing**> are accessible on pressing a hot key <  **Local parameters**>:













		Ask for multiplier	Causes setting a question for dosing process multiplier, i.e. the number which is used to multiply the values of mass of all components.
		Ask for number of cycles	Causes setting a question on number of dosing process cycles, i.e. number of repetitions of the same process.
		Confirm batching ingredients manually	Causes enabling manual confirmation by pressing "Enter/Print" key on terminal's keyboard for each weighing process.
		No. of weighments for calculating the correction	Determines the number of recent measurements which are analysed for calculating automatic correction in dosing
		Automatic cycle	Enables an already initiated process to be performed in a cyclic manner
		Global	Global settings of dosing process
		Batching outputs	Enables setting the outputs for dosing (fine dosing in case of two-step dosing process)
		Bulk batching output	Enables setting outputs for bulk dosing in case of two-step dosing process
		Correction	Enables determining global value of correction for all weighing platforms
	MAX 	Maximum correctional value	Enables determining maximal value of correction, which can be automatically determined for all weighing platforms











<  **Global** > settings are dedicated for the process of creating simple dosing processes, e.g.: dosing a single ingredient on all weighing platforms.

28.4. Description of functions and setting dosing process

While creating dosing process, the user has access to the following functions:

Icon	Short cut	Function	Description
	[DH]	Dose manually	Function recalling manual weightment of dosing process ingredient (manual dosing)
		Mass	Mass of an ingredient to be dosed
		Min	MIN threshold for dosing process ingredient
		Max	MAX threshold for dosing process ingredient
		Product	Dosing process ingredient uploaded from Products database
		Down-weighing	Enables switching on checkweighing mode (weighing on minus)
	[DA]	Automatic batching	Function enabling automatic weightment (automatic dosing). The function enables controlling outputs dedicated for dosing process.
		Mass	Mass of an ingredient to be dosed
		Mass for fast dosing	Mass of an ingredient for bulk dosing (in case of two-step dosing process)
		Product	Dosing process ingredient uploaded from Products database
		Down-weighing	Enables switching on checkweighing mode (weighing on minus)
	[O]	Outputs	Function enabling setting the status of terminal's outputs for controlling peripheral devices plugged to those outputs. Accessible settings: None – output disabled; "0" – output with low status; "1" – output with high status.









	[TI]	Delay	Function determining interval between carrying out the following dosing process steps. The function determines pending time for the following step counted in seconds.
		Time	Determination of pending time counted in seconds
		Description	Text description of an interval displayed on terminal's touch panel
	[Z]	Zero	Zeroing the weighing platform, equal to operation of the →0← function key on the terminal's front panel
	[T]	Tare	Tarring the weighing platform, equal to operation of the →T← function key on the terminal's front panel
	[ST]	Set Tare	Tare setting function, equal to operation of the <Set tare> function key on the terminal's front panel
	[CM]	Weight condition	Weight condition function determining time in which the following step of dosing process on a weighing platform should be carried out, e.g.: the following step is carried out if mass (net or gross) placed on the weighing platform is below the value set in threshold.
		Threshold	Value of mass set in threshold for the condition
		Mass	Kind of determined mass for threshold (net or gross)
		Weight condition	Weight condition – “>=” or “<”
	[CI]	Input condition	Conditional function, determining when the following step should be carried out, depending on status of terminal's input. Each input can take the following status: None – input disabled; „0” – input with low status; „1” – input with high status; „/” – input with increasing tendency (status change from low to high, e.g.: the moment of pressing a key); „\” – input with decreasing tendency (status change from high to low, e.g.: the moment of releasing a key)
	[EM]	Give mass	Function activating a so called: “mass in hand” – ingredient's mass of a dosing process supplied in ready packages with precisely determined mass. The given mass is added to weighed ingredient's mass, e.g.: ingredient to be weighed = 21,8 kg, weighed amount 1,8 kg placed on the scale, and 20 kg inserted manually.

	[ET]	Give number of batching repetitions	Function determining quantity of batches of weighed ingredient, that is added to a dosing process. Mass of a single batch is determined in a product selected from the database (Products database – field Mass). Product's mass is multiplied by a specific value, and such determined mass is added to weighing process. The function is applicable for weighing products in batches.
	[F]	Set flags	Function determining a condition (characteristic point) in dosing process. The function enables conditional carrying out another step in dosing process. Setting the characteristic point (signal flags) in connection with condition flags enables mutual conditioning of different processes on different weighing platforms.
	[CF]	Flags condition	Conditional function determining criteria for events, which have to occur in order to carry out the following step in dosing process.
	[DG]	Gravitational dosing	Function activating operation of automatic weighment (automatic dosing), with option of dosed mass flow measurement.
		Mass	Mass of a component which is to be dosed-out
		Percent	Mass threshold, given as a percentage [%], automatic dosing is realized within this threshold
		Product	Dosing process component selected from product database
		Time correction	Time correction \pm of closing a valve during the dosing process, given as [ms]
		Insensibility threshold	Permissible error \pm of dosed-out mass, given as a percentage [%]
		Minimal flow	Minimal flow value given as [g/s] or [kg/s] for an initiated algorithm of gravitational dosing
		Weighing in minus	Allows for turning on weighing in minus mode

28.5. Creating a new dosing process

Creating a new dosing process is initiated by specifying its name and code, followed by determining processes on each of the weighing platforms.

Procedure:

- Press  key and select option  **Databases**> from main menu → then select  **Dosing processes**>,
- In order to create a dosing process, press  **Add**> key, and confirm creating a new record in dosing process database,
- Specify name  > and code  > by pressing corresponding hot keys, and inserting a name and a code using an on-screen keyboard,
- Select weighing platform on which the dosing process is created, e.g.:  **Platform 1**>.
- By pressing  **Add**> key design a sequence of the dosing process to be carried out on a weighing platform no. 1, and next select one of available process functions (se table in point 28.4).
- There is a possibility of modifying an already designed process – adding or deleting a single step in a process, e.g.: in order to add an element in a process, press and hold for 4 seconds an element before which a new step should be added. Drop-down menu with available options is displayed

Edit
Add
Delete
Cancel

- Press “**Add**” and define new element of the process.

28.6. Instances of dosing processes

28.6.1. Instance 1 – Manual dosing process of 4 ingredients on 2 weighing platforms

Description:

A dosing process contains 4 ingredients, which are weighed on two weighing platforms:

- Weighing Platform 1: ingredients: Flour and Sugar
- Weighing Platform 2: ingredients: Seasoning and Water







Dosing process includes a condition, according to which before adding an ingredient “Water”, all other ingredients have to be dosed. The condition is marked with signal flags, which determine dosing process between the weighing platforms, in a way which orders dosing Water ingredient as the last one. The whole process is described below in tables, separately for each weighing platform.









Dosing process name: Instance 1

Dosing process code: 1111







Dosing process from a terminal level:









Platform 1:

Icon	Step	Value	Description
	1. [TI] Delay	[5s] Place empty container	Pending for loading an empty container for the first product
	2. [CI] Input condition	Input 1 – „/”	Input 1 has to take increasing tendency – press function key confirming loading a container
	3. [T] Tare	Tare	Tarring the weighing platform no. 1
	4. [DH] Dose manually	1 kg [Flour]	Manual weighing of product “Flour” to obtain 1 kg mass
	5. [TI] Delay	[5s] Unload container with product	Pending for unloading the container with weighed product from the weighing platform
	6. [CI] Input condition	Input 4 – „/”	Input 4 has to take increasing tendency – press function key confirming unloading a container from the weighing platform
	7. [Z] Zero	Zero	Zeroing the weighing platform no. 1

	8. [TI] Delay	[5s] Place empty container	Pending for loading an empty container for the second product
	9. [CI] Input condition	Input 1 – „/”	Input 1 has to take increasing tendency – press function key confirming loading a container
	10. [T] Tare	Tare	Tarring the weighing platform no. 1
	11. [DH] Dose manually	0,2 kg [Sugar]	Manual weighing product “Sugar” to obtain 0,2 kg mass
	12. [TI] Delay	[5s] Unload container with product	Pending for unloading the container with weighed product from the weighing platform
	13. [CI] Input condition	Input 4 – „/”	Input 4 has to take increasing tendency – press function key confirming unloading a container from the weighing platform
	14. [Z] Zero	Zero	Zeroing the weighing platform no. 1
	15. [F] Set flags	Set signal flag 1	Setting the characteristic point of the process, which is a condition for carrying out part of the process on the second weighing platform
	16. [O] Outputs	Output 1 – „1”	Input 1 takes the high status (“1”) – signal confirming carrying out the dosing process on the weighing platform no. 1 is lit up

Platform 2:

Icon	Step	Value	Description
	1. [TI] Delay	[5s] Place empty container	Pending for loading an empty container for the third product (the first product on the 2 weighing platform)
	2. [CI] Input condition	Input 9 – „/”	Input 9 has to take increasing tendency – press function key confirming loading a container
	3. [T] Tare	Tare	Tarring the weighing platform no. 2
	4. [DH] Dose manually	0,2 kg [Seasoning]	Manual weighing product “Seasoning” to obtain 0,2 kg mass
	5. [TI] Delay	[5s] Unload container with product	Pending for unloading the container with weighed product from the weighing platform
	6. [CI] Input condition	Input 12 – „/”	Input 12 has to take increasing tendency – press function key confirming unloading a container from the weighing platform
	7. [Z] Zero	Zero	Zeroing the weighing platform no. 2

	8. [CF] Flags condition	Signal flag 1 – „1”	Checking condition, whether signal flag 1 is set to value “1” – i.e. checking whether desired part of the process has been already realized on the weighing platform no. 1. If Yes, then dosing process on the second weighing platform shall continue.
	9. [O] Outputs	Output 1 – „0”, Output 12 – „1”	Output 1 is set to low status – the signal for completing dosing process on the weighing platform no. 1 is switched off; output 12 takes the high status – the main water valve is opened, for manual dosing of water ingredient.
	10. [DH] Dose manually	2 kg [Water]	Manual weighing product “Water” to obtain 2kg mass
	11. [O] Outputs	Output 12 – „0”	Output 12 is set to low status – the main water valve is closed
	12. [TI] Delay	[5s] Unload container with product	Pending for unloading the container with weighed product from the weighing platform
	13. [CI] Input condition	Input 12 – „”	Input 12 can take increasing tendency – press function key confirming unloading a container from the weighing platform
	14. [O] Outputs	Output 9 – „1”	Output 9 is set to high status („1”) – signal confirming carrying out the dosing process on the weighing platform no. 2 is lit up
	15. [TI] Delay	[5s] Dosing process completed	Displaying a text message on the terminal confirming completion of dosing process.

Completing dosing process causes switching off all outputs of the terminal.

28.6.2. Instance 2 – Automatic dosing of 2 ingredients on 2 weighing platforms

Description:

The dosing process consists of 2 ingredients which will be weighed on 2 weighing platforms:

- Weighing Platform 1: ingredient Flour
- Weighing Platform 2: ingredient Water

The dosing process is carried out automatically, and includes a condition, that the dosing sequence is strictly determined – dosing of “Water” ingredient can be initiated only on completing the dosing process of ingredient “Flour”.







The condition is marked with signal flags, which determine formulation making process between the weighing platforms, in a way which orders dosing Water ingredient as the second one. The whole process is described below in tables, separately for each weighing platform.

Dosing process name: Instance 2

Dosing process code: 2222









Dosing process from a terminal level:

Platform 1

Icon	Step	Value	Description
	1. [CM] Weight condition	Gross<0.1 kg	Condition checking, unless the weighing platform is loaded with a mass exceeding 100 g
	2. [Z] Zero	Zero	Zeroing the weighing platform no. 1
	3. [TI] Delay	[5s] Open valve Flour	Pending for opening main valve of the container with "Flour"
	4. [DA] Automatic batching	1,2 kg [Flour]	Automatic dosing of product „Flour” to obtain 1 kg mass in bulk dosing mode (bulk dosing and fine dosing valves are opened – Outputs 1 and 2), and 0,2 kg mass is dosed using fine dosing valve only –fine dosing valve is opened on Output 1 (for two-step dosing process)
	5. [TI] Delay	[3s] Close valve „Flour ”	Pending for closing the main valve of the container "Flour"
	6. [O] Outputs	Output 11 – „1”	Output 11 takes high status („1”) – signal confirming carrying out the dosing making process on the weighing platform no. 1 is lit up
	7. [F] Set flags	Signal flag 1 – „1”	Setting the characteristic point of the process, which is a condition for carrying out part of the process on the second weighing platform

Dosing on the first weighing platform is carried out in two-steps, as for ingredient „Flour” the outputs are set for two-step dosing – see Products database.

Platform 2

Icon	Step	Value	Description
	1. [CF] Flags condition	Signal flag 1 – „1”	Checking condition, whether signal flag 1 is set to value “1” – i.e. checking whether desired part of the process has been already realized on the weighing platform no. 1. If Yes, then dosing process on the weighing platform no. 2 shall start.
	2. [CM] Weight condition	Gross<0.1 kg	Condition checking, unless the weighing platform is loaded with a mass exceeding 100 g
	3. [Z] Zero	Zero	Zeroing the weighing platform no. 2
	4. [TI] Delay	[5s] Open valve Water	Pending for opening main valve of the container with “Water”
	5. [DA] Automatic batching	2,2 kg [Water]	Automatic dosing of ingredient “Water” to obtain 2,2 kg mass in single-step dosing mode – Output 6 controls the dosing valve
	6. [TI] Delay	[5s] Close valve Water	Pending for closing the main valve of the container “Water”
	7. [O] Outputs	Output 12 – „1”	Output 12 takes high status (“1”) – signal confirming carrying out the dosing process on the weighing platform no. 2 is lit up
	8. [TI] Delay	[5s] Dosing process completed	Displaying a text message on the terminal confirming completion of dosing process.

Additionally, in automatic dosing process, additional setting of dosing outputs for dosed ingredients have to be made – see Products database settings.

28.6.3. Instance 3 – Mixed dosing process

Description:

A dosing process contains 4 ingredients, which are weighed on two weighing platforms:

- Weighing Platform 1: ingredients Flour, Sugar and Seasoning,
- Weighing Platform 2: ingredients: Water

Dosing process is carried out manually and automatically, and it includes a condition that the dosing sequence is strictly determined – dosing of “Water” ingredient can be initiated only on completing the dosing process of ingredient “Flour” and “Sugar”. Ingredient “Seasoning” will be added as the last one to the dosing process.











The condition is marked with signal flags, which determine formulation making process between the weighing platforms, in a way which orders dosing “Water” ingredient is dosed in an appropriate time. The whole process is described below in tables, separately for each weighing platform.



















Dosing process name: Instance 3

Dosing process code: 3333









Dosing process from a terminal level:

Platform 1:

Icon	Step	Value	Description
	1. [TI] Delay	[5s] Place container Flour on the weighing platform	Pending for loading container “Flour” on the weighing platform no. 1
	2. [CI] Input condition	Input 1 – „/”	Input 1 has to take increasing tendency – press function key confirming loading a container
	3. [T] Tare	Tare	Tarring the weighing platform no. 1
	4. [DH] Dose manually	1 kg [Flour]	Manual weighing product Flour to obtain 1 kg mass
	5. [TI] Delay	[7s] Unload container with product	Pending for unloading the container with “Flour”
	6. [CI] Input condition	Input 4 – „/”	Input 4 has to take increasing tendency – press function key confirming unloading a container from the weighing platform
	7. [O] Outputs	Output 1 – „1”	Signal on completing dosing ingredient “Flour”
	8. [Z] Zero	Zero	Zeroing the weighing platform no. 1
	9. [TI] Delay	[5s] Place container Sugar on the weighing platform	Pending for loading container “Sugar” on the weighing platform no. 1
	10. [CI] Input condition	Input 1 – „/”	Confirm loading of container “Sugar”

	11. [T] Tare	Tare	Tarring the weighing platform no. 1
	12. [DH] Dose manually	0,4 kg [Sugar]	Manual weighing product Sugar to obtain 0,4 kg mass
	13. [TI] Delay	[5s] Unload container with product	Pending for unloading the container with "Sugar"
	14. [CI] Input condition	Input 4 – „1”	Input 4 has to take increasing tendency – press function key confirming unloading a container from the weighing platform
	15. [O] Outputs	Output 2 – „1”	Signal on completing dosing ingredient "Sugar"
	16. [Z] Zero	Zero	Zeroing the weighing platform no. 1
	17. [CI] Input condition	Input 5 – „1”	Confirm pouring ingredients to a mixer
	18. [F] Set flags	Signal flag 1 – „1”	Setting the characteristic point of the process, which is a condition for carrying out part of the process on the weighing platform no. 2
	19. [O] Outputs	Output 5 – „1”	Lighting up a signalling device confirming pouring the ingredients to the mixer
	20. [CF] Flags condition	Signal flag 1 – „1” Signal flag 2 – „1”	Pending for automatic dosing of water on the weighing platform no. 2
	21. [TI] Delay	[5s] Place container Seasoning on the weighing platform	Pending for loading container "Seasoning" on the weighing platform no. 1
	22. [CI] Input condition	Input 1 – „1”	Confirm loading of container "Seasoning"
	23. [T] Tare	Tare	Tarring the weighing platform no. 1
	24. [DH] Dose manually	0,25 kg [Seasoning]	Manual weighing product Seasoning to obtain 0,25 kg mass
	25. [TI] Delay	[5s] Unload container with product	Pending for unloading the container with "Seasoning"
	26. [CI] Input condition	Input 4 – „1”	Input 4 has to take increasing tendency – press function key confirming unloading a container from the weighing platform
	27. [O] Outputs	Output 3 – „1”	Signal on completing dosing ingredient "Seasoning"
	28. [TI] Delay	[10s] Dosing completed	Displaying a text message on the terminal confirming completion of dosing process

Platform 2:

Icon	Step	Value	Description
	1. [CF] Flags condition	Signal flag 1 – „1”	Checking condition, whether signal flag 1 is set to value “1” – i.e. checking whether desired part of the process has been already realized on the weighing platform no. 1. If Yes, then dosing process on the weighing platform no. 2 shall start.
	2. [T] Tare	Tare	Tarring the weighing platform no. 2
	3. [TI] Delay	[5s] Open valve Water	Pending for opening main valve of the container with “Water”
	4. [DA] Automatic batching	2 kg [Water]	Automatic dosing of ingredient “Water” to obtain 2 kg mass in single-step dosing mode – Output 6 controls the dosing valve (set for Water in Products database)
	6. [TI] Delay	[5s] Close valve Water	Pending for closing the main valve of the container “Water”
	7. [O] Outputs	Output 12 – „1”	Output 12 takes high status (“1”) – signal confirming carrying out the dosing process on the weighing platform no. 2 is lit up
	8. [F] Set flags	Signal flag 1 – „1” Signal flag 2 – „1”	Setting the characteristic point of the process, which is a condition for carrying out part of the process on the weighing platform no. 1
	8. [TI] Delay	[10s] Dosing completed	Displaying a text message on the terminal confirming completion of dosing process

An instance of mixed dosing (manual and automatic) has been extended by signalling its corresponding phases to present the possibilities of the working mode **<Dosing>**.

28.7. Reporting of completed dosing processes

On completing each dosing process, the terminal automatically generates a report on that process.

Caution:

Submenu:  **Devices** /  **Printer** /  **Printouts** /  **Dosing report printout template**” enables optional modifying of the report template (see ch. 16.2.3 of this user manual).

Default form of the report from dosing template:

```
-----  
Dosing process  
-----  
{40:Start date:,-25}{180}  
{40:End date:,-25}{181}  
{40:Name:,-25}{175}  
{40:Code:,-25}{176}  
{40:Status:,-25}{182}  
{40:Measurements:,-25}  
-----  
{185:(50,-20) (7)(11)  
(40:Nominal Mass:,-25)(186)(11)  
(40:Difference:,-25)(187)(11)  
-----  
}{40:Mass:,-25}{184}{11}  
-----
```



The report from each completed process is simultaneously saved in the database of  **Report from dosing**, where the files are named by their date and hour of process execution and dosing process status. List of data for the dosing process – see ch. 35.5.2 of this user manual.









29. WORKING MODES – FORMULATION

 **Formulation** is a working mode designed for creating formulations of products on a scale.



29.1. Starting the working mode





Procedure:



- While in main window of the software, press  on-screen key, located in the top bar of the window, which opens submenu **< Working Modes** containing list of available working modes,
- Select working mode  **Formulation** >, the software automatically returns to displaying the main window, and the top bar indicates the icon of selected working mode ,
- Automatically the following on-screen keys are enabled:

-  Local parameters
-  Select formulation
-  Start formula making process
-  Stop formula making process
-  Select formulation ingredient from the list
-  Select previous formulation ingredient to to be processed
-  Select net formulation ingredient to be processed
-  Set “mass from hand” – mass of an ingredient supplied in ready packaged and with determined mass
-  Edit lot number of an ingredient and/or sample of a formulation ingredient

29.2. Local setting of a working mode





Local settings for the working mode <  **Formulation** > are accessible on pressing a hot key <  **Local parameters** >:

	Ask for multiplier	Causes setting a question for formulation multiplier, i.e. the number which is used to multiply the values of mass of all formulation components.
	Ask for number of cycles	Causes setting a question on number of formulation cycles, i.e. number of repetitions of the same formulation.
	Confirm batching ingredients manually	Causes enabling manual confirmation by pressing “Enter/Print” key on terminal’s keyboard for each weighing process.
	Automatic tare	Enable automatic tarring of mass at the moment of process start and mass of each following ingredient after the sampling process.
	Ingredient control	Enable control mode of an ingredient being part of a formulation. The “ Ingredient control ” mode orders giving correct ingredient code before its weighing process.







	Portion weighing	Enable portion weighing mode of a formulation for a random number of portions (samples) until obtaining a target mass.
	Report printout	Enable automatic printout of a formulation report after completing the formula making process

29.3. Creating a new formulation

Procedure:

- Press  key and select option  **Databases** from main menu → then select  **Formulation**,
- In order to create a formulation, press  **Add** key, and confirm creating a new record in formulation database.

List of data specified for a new formulation:











	Name	Formulation name
	Code	Formulation code
	Ingredients	Defining formulation ingredients
	Number of ingredients	Previewing number of ingredients in a formulation
	Formulation mass	Previewing total mass of a formulation
	Type of charge *	Type of a measuring series for a formulation
	Charge	A measuring series of a formulation

*) – the charge type is definable as one of three values:

None	Function disabled
Global	Charge is carried out globally for the complete formulation
By ingredient	Charge is carried out sequentially for each ingredient

- After entering a selected weighing platform add the formulation ingredients one by one by pressing <  Add > key.

List of data created for an ingredient of a formulation:

	Name	Name of an ingredient in a formulation
	Code	Code of an ingredient in a formulation
	Product	An ingredient of a formulation selected from the database of products
	Mass	Mass of an ingredient
	Deviation type	Declaring the deviation type: the measuring unit for an active weighing platform or the value in [%]
	Low deviation	Low deviation of an ingredient's mass
	High deviation	High deviation of an ingredient's mass
	Dispensing	Enabling down-weighing (weighing to minus) mode
	Platform	Assigning weighing platform number to an ingredient
	Dispensing	Enabling down-weighing (weighing to minus) mode

1) – In case of selecting an ingredient from the database of products the software displays the following message:

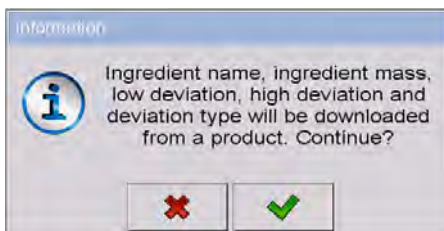

2) – in case of declaring mass of an ingredient, and when the mass exceeds the maximum capacity of a weighing platform, the software displays the following message:

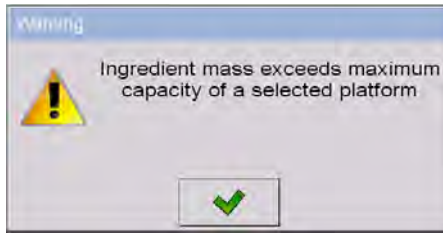

3) – in case of declaring the value of the low deviation as greater than the declared ingredient mass, the software displays the following message:

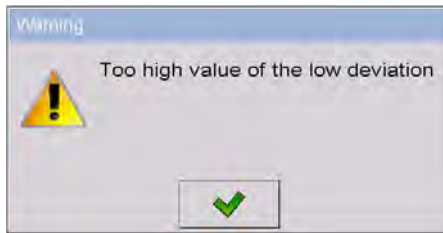

4) – in case the sum of ingredients mass and the value of high deviation are exceeding the maximum capacity of a weighing platform, the software displays the following message:

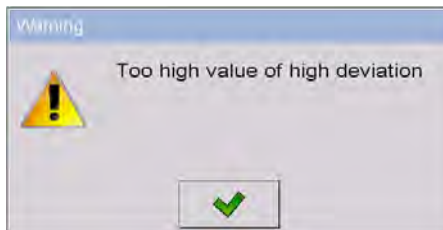

- On entering the required data press  key which is equal to creating a new ingredient and adding it to the formulation composition.
- A created entry on the list comprises: the following number on the list, ingredient's name (selected from the database of products) and mass to be weighed.
- The software enables modifying an existing list of ingredients, i.e. adding or deleting an ingredient, e.g. in order to add an ingredient press and hold for about 4 seconds an entry on the list before which the ingredient should be added. The following menu with below content is displayed:

Edit Add Delete Cancel



- Press “**Add**” and define a new ingredient of a formulation.
- After specifying all ingredients of a formulation go back to the main window by pressing  key.

29.4. Formula making process





Starting the formula making process requires that the authorization (access level) of the logged user is sufficient to start the process.

Caution:

1. *Starting the process requires that the logged user has access level at least of an **<operator>**. If the logged user or anonymous operator have access level set to **<none>** then on process start the software displays a message: **<Unauthorized access >**.*
2. *The Logging procedure is described in point 11 of this user manual, and the procedure of determining the access level for scale users is described in point 19 of this user manual.*

- Press an on-screen button  to select a required formulation.
- Enter to scale's memory general parameters on the working mode (in accordance with point 29.2 of this user manual),
- After returning to the main window of the **<  Formulation >** mode press the on-screen function key  (process start),
- If the ingredient control mode is enabled, then the scale software opens an editing window **<Ingredient control>** with a numeric keyboard and an editing field for entering a correct code of the weighed ingredient using a barcode scanner. Weighment of each following ingredient requires giving its corresponding code.

In case when:

1. The inserted code of the current ingredient is incorrect, and the ingredient is in formulation composition, the software displays the following message: **<Incorrect Ingredient Code. Ingredient already in formulation content. Go to this ingredient?>**. Accept this message by pressing  key. The software goes to the weighing process of the ingredient. If  key is pressed, the software returns to displaying the editing window **<Ingredient control >** featuring the numeric keyboard for entering the correct code of an ingredient.
 2. The inserted code of the current ingredient is incorrect, and the ingredient is not in the formulation composition. The software displays a message: **<No ingredient with specified code. Abort?>**. On accepting the message by pressing  key the software goes to another ingredient on the list. If  key is pressed then the software returns to displaying the editing window **<Ingredient control>** featuring the numeric keyboard for entering the correct code of an ingredient.
 3. If the inserted code of the current ingredient is correct, then the software displays a message: **<Correct Ingredient code>** and goes to ingredient's weighing process.
- The workspace on the display indicates a bargraph denoting mass of a weighed ingredient of a formulation and the following information:

Process in progress: Test formulation

Ingredient: 1 / 3 [Ingredient 1]

Portion: 0 g / -500.0 g

Charge: 1 / 10



Completed: 0%

Where:

Process in progress:	Process status
Test formulation	Name of prepared formulation
Ingredient: 1 / 3	Number of weighed ingredient / Total number of ingredients in a formulation
[Ingredient 1]	Name of the weighed ingredient
Portion: 0 g	Current mass of the weighed ingredient

Portion: -500.0 g	Current deviation from the reference mass
Charge: 1 / 10	Number of weighed charge / Total number of charges
Completed: 0%	Process progress

Caution:

- If on process start the weighing platform is loaded, the software will indicate message **<Load appropriate product>** while trying to accept a measurement.
- If a user tries to accept the following weighed mass without changing mass of the load placed on the weighing platform, the software displays a message **<Load appropriate product>**,
- If a user tries to accept mass of a portion while the parameter **<Portion weighing>** is disabled then the software displays the following message **<Load appropriate product>**,
- If a user tries to accept an exceeded value of permissible ingredient mass, then the software displays the following message **<Permissible value of ingredient mass exceeded. Recalculate ingredients?>**. On rejecting the message by pressing  key the software returns to the previous step. On accepting the message by pressing  key the software automatically recalculates mass of the ingredients proportionally to the exceeded value of mass and returns to formulation making process.
- If a user tries to accept an unstable mass indication, the software displays a message **<Measurements unstable>**.

A user can abort the formula making process at optional moment by pressing an on-screen function key  (process stop) located in the bottom bar of the terminal's display.

29.5. Reporting from completed formula making processes

On completing each formula making process, the terminal automatically generates a report on that process.

Caution:

Submenu:  **Devices** /  **Printer** /  **Printouts** /  **Formulation report printout template**” enables optional modifying of the report template (see ch. 16.2.3 of this user manual).

Default form of the report template from formula making process:

```
-----  
Formulation  
-----  
{40:Start date:,-25}{240}  
{40:End date:,-25}{241}  
{40:Name:,-25}{220}  
{40:Code:,-25}{221}  
{40:Status:,-25}{242}  
{40:Measurements:,-25}  
-----  
{245:(50,-20) (7)(11)  
(40:Nominal Mass:,-25)(246)(11)  
(40:Difference:,-25)(247)(11)  
-----  
}  
-----  
{40:Mass:,-25}{244}  
-----
```

The report from each completed formula making process is simultaneously saved in the database of  **Reports From Formulation**, where the files are named by their date and hour of process execution and formulation status. List of data for the formula making process – see ch. 35.5.3 of this user manual.

30. WORKING MODE – CPG (CONTROL OF PREPACKED GOODS)

Working mode  **CPG** enables carrying out a control of prepacked goods (single stand of network) that is supported by database containing list of products and operators. A control started from a scale is completed automatically after checking an appropriate quantity of packages (samples).

The scale allows for connecting it with a PC computer featuring computer software **E2R SYSTEM** and thus forming a multiposition (network) system. Each scale in the network system is an independent weighing stand, and data on the control process is sent to the computer software on the real time basis.

The computer software enables real time acquiring data from each connected scale. The system allows for starting a control process from the scale or from the level of computer software.

The acquired data allow for carrying out a quality control of manufactured packaged goods for:

- Compatibility with the Regulation by the Central Office of Measures of 3 April 1997 on the requirements for a quality control of prepacked goods – by random selecting measurement results and sending them to the procedure of **control of prepacked goods**,
- Compatibility with an internal quality control system of an organization.

Caution:

Establishing a connection of a scale with the  **E2R System** is described in ch. 16.1.5 of this manual.

30.1. Starting the working mode

Procedure:

- While in main window of the software, press  on-screen key, located in the top bar of the window, which opens submenu **<Working Modes>** containing the list of available working modes,
- Select working mode **<e CPG>**, the software switches to displaying the home screen of the enabled working mode:

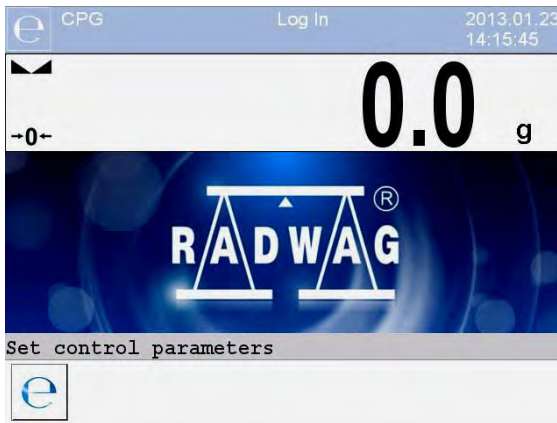

Where:





Entering control settings window

30.2. Control settings mode window

Caution:

Before entering the control settings mode carry out Logging procedure, as described in ch. 11.1 of this manual.

Press  button located at the bottom of the < CPG> mode home screen which opens control settings window:





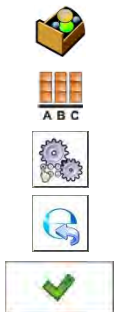





Where:





- Selecting product from the database
- Declaring number of the controlled batch
- Working mode local settings
- Returning to the working mode home screen
- Control start

30.3. Local setting of a working mode

Local settings of the working mode < **CPG**> are accessible on pressing a hot-key < **Local parameters**> in the control settings window:

	Save mode	Detailed description in ch. 24.1 of the user manual
	Number of accessible controls	Enabling simultaneous carrying out two control processes (see ch. 30.12 of this manual)
	Ask for batch number	Function triggering providing batch number before the start of control
	Password required	Enabling the parameter requires Logging in to the scale before each entering the mode settings window
	Saving notification window	Protection preventing record of unreliable results of controlled product measurement. Value expressed as deviation [%] form nominal weight of controlled product.
	Information about saved measurement	Detailed description in ch. 24.10 of the user manual

30.4. Editing a product to be controlled

A product is edited in submenu “ /  **Databases**”.

















Caution:

*In case the scale cooperates with a computer software < **E2R System**> editing the databases from the scale level is blocked. Editing and exporting product records to the scales is carried out from the level of computer software.*



Procedure:

- Enter submenu “ /  **Databases**”,
- Enter database < **Products**> and press required product record.

List of data definable for a control:

Pictogram	Data name	Description
	Name	Product name
	Code	Product code
	Mass	Product nominal mass
	Tare	Product tare value (set automatically on selecting a product from the database)
	CPG	-
	CPG mode	Control type: Non-destructive Average Tare, Non-destructive Empty-Full, Destructive Full-Empty, Destructive Empty-Full
	Lot size	Declaring quantity of a controlled batch (Maximum value 999999)
	Charge	Measuring series to be controlled: Non-destructive Empty-Full, Destructive Full-Empty, Destructive Empty-Full
	Unit	Product's weighing unit: [g] or [ml]
	Density	Product density (range of entered values has to contain between 0,1g/cm ³ and 5g/cm ³)
	Quantity of packages	Declaring quantity of packages to be controlled for determining average tare (for control type "non-destructive average tare")
	Cyclic displaying of average tare	Turning on  / turning off  an option of cyclic estimation of average tare for a product.
	Interval of average tare determination [h]	Value of time determining frequency of tare control during a process of product control. This means that estimation of average tare for a product will be carried out in accord with declared interval.
	Remind about measurement every [min]	Activating message reminding about need of next measurement performance
	Internal control	Submenu for defining internal criteria of a control (see table below)

- List of data for internal criteria

Internal control	Enabling  / disabling  internal control criteria
Sample quantity	Quantity of a product sample
Error value [- T]	Value of negative permissible error $-T$, set in a weighing unit determined for the product. Measurements below the $Q_n - T$ value will be comprehended as defective.
Error value [+ T]	Value of positive permissible error $+T$ set in a weighing unit determined for the product. Measurements above the $Q_n + T$ value will be comprehended as defective.
Quantity of disqualifying samples [$Q_n - 2T$]	Number of recorded negative errors $-2T$ in a tested sample that disqualifies a control
Quantity of disqualifying samples [$Q_n + 2T$]	Number of recorded positive errors $+2T$ in a tested sample that disqualifies a control
Quantity of disqualifying samples [$Q_n - T$]	Number of recorded negative errors $-T$ in a tested sample that disqualifies a control
Quantity of disqualifying samples [$Q_n + T$]	Number of recorded positive errors $+T$ in a tested sample that disqualifies a control
Average limit value	Mode for calculating the average limit value (constant or automatic)
Average limit value [-]	Average limit value (negative) for a tested sample (refers to average limit value as a "constant")
Average limit value [+]	Average limit value (positive) for a tested sample (refers to average limit value as a "constant")
Factor value [- W_k]	Standard deviation multiplier for the average limit value (negative) determined in the automatic mode
Factor value [+ W_k]	Standard deviation multiplier for the average limit value (positive) determined in the automatic mode

30.5. Control start procedure

To start testing:

- An operator needs to be logged on with the authorization access level high enough to perform testing.

Caution:

The Logging on procedure is described in ch. 11. The procedure of outlining the authorization level is described in ch. 19 of this manual.

- Select a product to be tested with correctly determined data for the control process,
- Enter to scale memory general parameters on control mode (in accordance with ch. 30.2 and 30.3 of this manual),
- Remove load from the weighing pan,
- Press function hot-key  (control start) located in the bottom bar of the settings window, which opens an information window on entered data:



where:



Abort control start



Control start

Caution:

If before control start the operator:

- Does not remove a load from the weighing pan or other criteria for zeroing are failed (e.g. unstable weighing result) the scale displays a message: **<Unable to start control. Zeroing error>**,
- Does not log in or the logged operator is not authorized to carry out the control, the scale displays a message: **<No authorization>**,
- Does not select a product from the database, the scale displays a message: **<Product not selected >**,
- Does not declare batch quantity, the scale displays a message: **<Batch quantity not entered >**.

30.6. Control aborting procedure

After control start an operator can abort the control process in an optional moment by pressing a function hot-key  (control stop) located in the bottom bar of the control process window.

Pressing the  (control stop) key is followed by displaying a message:



Pressing  key causes reuniting to the control process in progress.

Pressing  key causes terminating the control and returning to settings of the **CPG** mode.



Simultaneously, a control report with status **<Terminated>** is added to the database of  **Controls**.

30.7. Logging out from a control process in progress

Procedure:

- While in control mode press pictogram with name of the logged operator located in the bottom bar of the display,
- The operator is automatically logged out and simultaneously a window **<Insert Password>** for Logging in is displayed with the name of the previously logged operator:



- Enter correct password and press  key to automatically return to the control process in progress,
- Pressing  key causes returning to the home screen of the **CPG** mode:





where:

Restart control - information for an operator on a possibility to resume a control process in progress



- Control resuming button

- Pressing the  button causes displaying a Logging in window **<Insert Password>** with the name of previously logged operator.
- After entering a correct password and accepting it by pressing  key the scale automatically returns to the control process in progress.

30.8. Non-destructive average tare control mode

Before starting the control process the user can determine average tare by weighing packages. The option is enabled by activating a function **<Average Tare Estimation>** in the **CPG** mode settings.

Tare control process is accompanied by below window:

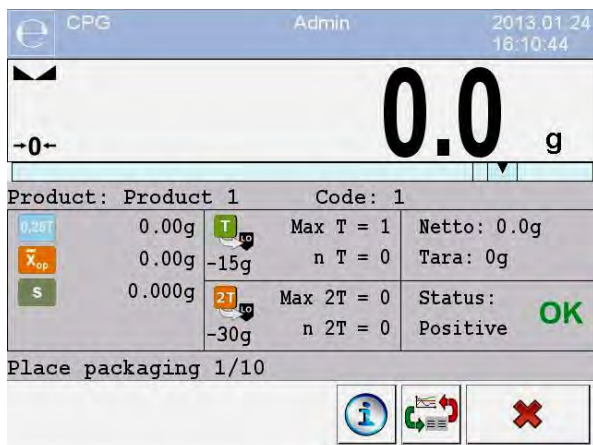

Where:

Product - Product name
Code - Product code

0,25T

\bar{x}_{op}

S

T₁₀

2T₁₀

Net

Tare

Status

Place packaging





- **0,25T** criterion value in [g]
- Average tare of a packaging in [g]
- Standard deviation
- Characteristics of negative errors **T1** in a sample
- Characteristics of negative errors **2T1** in a sample
- Net mass of the controlled package
- Packaging tare
- Packaging control status
- Command on control process with quantity of all packages to be weighed
- Data on a control in progress
- Converting the workspace into a chart
- Control completion

Caution:

*In order to carry out a product control using “**non-destructive average tare**” mode, in accordance with the regulation on standard deviation “**S**”, the mass of packages is determined from at least **10** measurements, and the standard deviation cannot be greater than **0.25** of the maximum permissible negative error **T** for nominal mass of a package.*

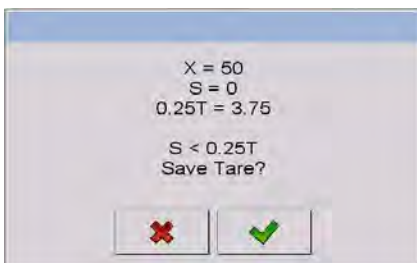
If an operator carries out the last measurement of the packaging mass, the software displays a summary of the process. Automatically, the system generates a report is saved in the scale database:



Pressing  key causes moving to the control process without saving the determined average mass of a packaging in product record in the database.

Pressing  key causes moving to the control process with simultaneous saving the determined average mass of a packaging in product record in the database.

During the control process in progress the software carries out real-time updating of measurement results and displays them in the corresponding fields for informing an operator on control result:

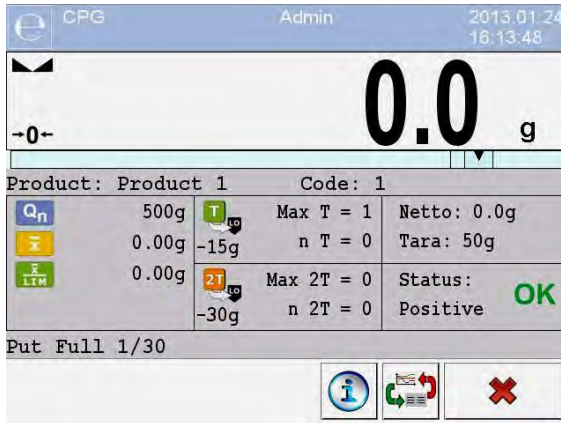

Where:

Product

- Name of the controlled product

Code

- Code of the controlled product



- Nominal value of the controlled product



- Average mass of the controlled product



- Value of the disqualifying average

 Max T = 1
-15g n T = 0

- Characteristics of negative errors **T** in a sample:

-15g – value of the negative error **T**,

Max T – permissible number of the negative errors **T**,

n T – actual number of the negative errors **T**

 Max 2T = 0
-30g n 2T = 0

- Characteristics of negative errors **2T** in a sample:

-30g - value of the negative error **2T**,

Max 2T - permissible number of the negative errors **2T**,

n 2T - actual number of the negative errors **2T**

Net

- Net mass of the controlled product

Tare

- Tare of the packaging

- Status** - Control status: positive, negative
- Put full** - Commands on control process with quantity of all measurements in a batch
- Data on a control process in progress
 - Change of the workspace: numerical data / chart
 - Control completion



• **Control status**

Control status features a corresponding graphic interpretation:



- positive,



- negative (permitted to control sample 2)



- negative

In case of status marked with pictogram a corresponding workspace field changes its colour to yellow:

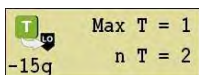

- Permissible number of negative errors **T1** exceeded, but control of sample 2 permitted

In case of status marked with pictogram a corresponding workspace field changes its colour to red:



- Average mass of the controlled product below the value of the disqualifying average

• **Data on control process in progress**

Pressing key displays data on a control process in progress:

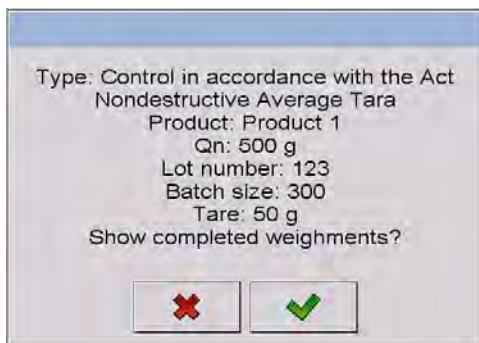

Pressing  key causes returning to the control process in progress.

Pressing  key causes moving to displaying a list of completed weighments:

CPG		
	1. 2013.01.24 16:38:17	522.8g
	2. 2013.01.24 16:38:33	472.8g
	3. 2013.01.24 16:38:34	472.8g
	4. 2013.01.24 16:38:41	522.8g
	5. 2013.01.24 16:38:42	522.8g
	6. 2013.01.24 16:38:43	522.8g

Buttons:   

In order to return to the control process in progress press  key.

- **Change of the workspace**

Pressing  key causes displaying the workspace in a form of chart with measurement results:

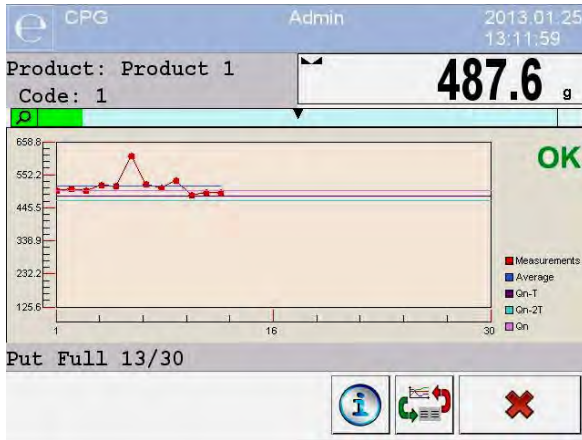

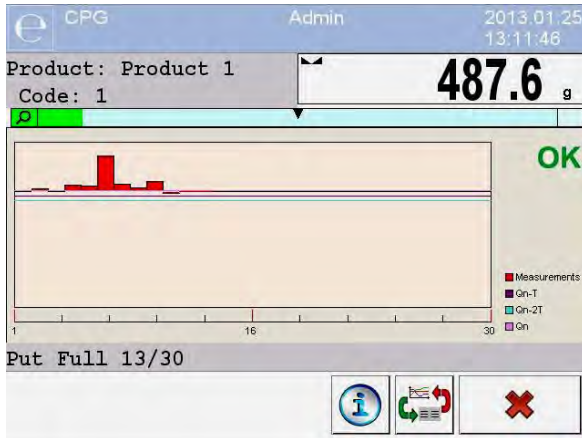

Additionally, pressing the workspace area enables an operator to change its format (from a line chart to a bar chart):



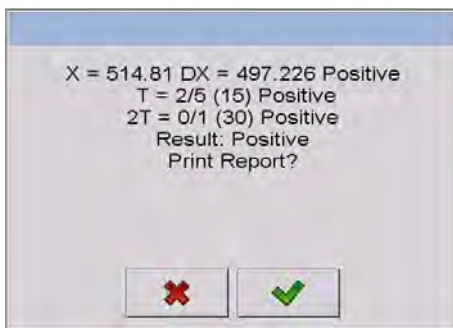

In order to disable the chart press  key for the second time.

After completing the control the scale generates a process summary, and the accomplished control is automatically saved in the scale database:



Pressing  key causes printing a report on a printer connected to the scale.

Pressing  key causes returning to settings window of the working mode  **CPG** without printing a report.

Caution:

*In case the scale cooperates with the computer software  **E2R System** the message on process summary does not contain a option for printing a report. The data on a control is automatically sent to the computer software with possibility of printing the report from the computer level.*

If the test result is that the number of errors **T**, according to the regulations, requires expanding the sample. Operator is informed about it the following message box:

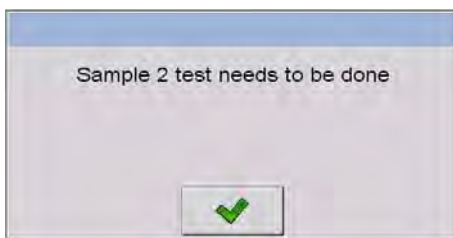

Press  and then some descriptions and boundary criteria are changed. After the test has been completed the test is summarized and the results are automatically saved in the database and the report can be printed on an attached printer.

Caution:

A pattern and example of the report from testing products are described in ch. 30.14 of this manual. A pattern and example of the report from estimating average tare are described in ch. 30.13 of this manual.

30.9. Performing non-destructive testing in mode Empty-Full

For mode „Non-destructive Empty-Full” a user sets the measurement “charge” in the product data. According to the set „charge” a message is shown that informs about putting empty packages first and then the same packages after they have been filled up in the same sequence:

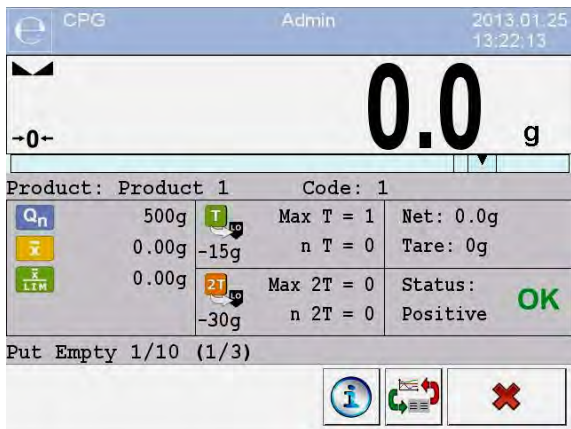

Where:

Product

- Name of the controlled product

Code

- Code of the controlled product



- Nominal value of the controlled product



- Average mass of the controlled product



- Value of the disqualifying average

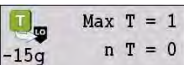

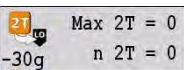

- Characteristics of negative errors **T1** in a sample (in accordance with ch. 30.6 of this manual)



- Characteristics of negative errors **2T1** in a sample (in accordance with ch. 30.6 of this manual)

Net

- Net mass of the controlled product

- Tare** - Tare of the packaging
- Status** - Control status (in accordance with ch. 30.6)
- Put Empty 1/10** - Commands on control process
- (1/3)** Value of the measuring lot
-  - Data on a control process in progress (in accordance with ch. 30.6 of this manual)
-  - Change of the workspace: numerical data / chart (in accordance with ch. 30.6 of this manual)
-  - Control completion

After the test has been completed the test is summarized (see ch. 30.8) and the results are automatically saved in the database.

Caution:

A pattern and example of the report from estimating average tare are described in ch. 30.14 of this manual.

30.10. Performing destructive testing in modes Empty-Full and Full-Empty

“**Destructive**” control process complying with the regulation, and independently on the batch size that exceeds 100 pcs., the size of a sample accepted by the software for control process is 20 pcs. Other control criteria are accepted as specified in the regulation.

After selecting from a list a product with set options for the destructive control with determined measuring “**lot**”, and starting the control process, the software will display messages facilitating the control process (as in the case of control process described above).

Depending on the set control mode, the scale orders the following sequence of weighing products: “**empty-full**” or “**full-empty**”.

Caution:

Remember to maintain the order for weighing products with packages and empty packages. It is important to the software that carries out mass calculations of products placed in a specific packaging.

After the test has been completed the test is summarized (see ch. 30.8) and the results are automatically saved in the database.

Caution:

A pattern and example of the report from estimating average tare are described in ch. 30.14 of this manual.

30.11. Control in accordance with internal criteria

Select a product with correctly determined parameters for carrying out the control in accordance with the internal criteria (see ch. 30.4 of this manual).

After entering to scale memory general parameters of the working mode (in accordance with ch. 30.2 and ch. 30.3 of this manual), start control process

by pressing  key (control start) located in the bottom bar of the mode settings window.

The scale automatically displays a window with data on set control parameters:

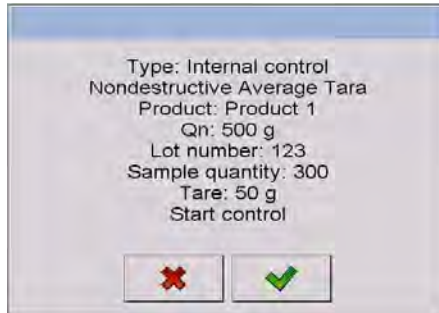

Accept the message box by pressing  key which causes moving to the control process. During control process the software carries out real-time monitoring of the measurement results and displays them in the corresponding fields of the display for informing the operator on control result:

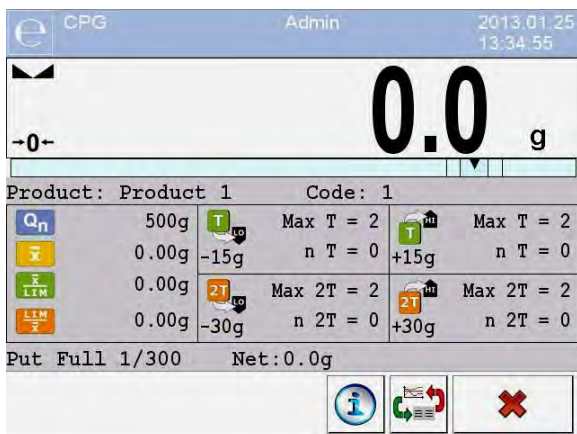

Where:

Product

Code

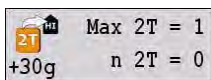
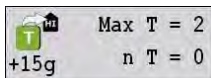
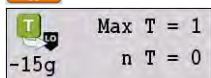

Put Full 1/30

Net



- Name of the controlled product
- Code of the controlled product
- Nominal value of the controlled product
- Average mass of the controlled product
- Value of the negative disqualifying average
- Value of the positive disqualifying average
- Characteristics of negative errors **T** in a sample (in accordance with ch. 30.6 of this manual)
- Characteristics of negative errors **2T** in a sample (in accordance with ch. 30.6 of this manual)
- Characteristics of positive errors **T** in a sample:
 - +15g** - value of the positive error **T**,
 - Max T** - permissible number of the positive errors **T**,
 - n T** - actual number of the positive errors **T**
- Characteristics of positive errors **2T** in a sample:
 - +30g** - value of the positive error **2T**,
 - Max 2T** - permissible number of the positive errors **2T**,
 - n 2T** - actual number of the positive errors **2T**
- Command on control process
- Net mass of the controlled product
- Data on a control process in progress (in accordance with ch. 30.6 of this manual)



- Change of the workspace: numerical data / chart (in accordance with ch. 30.6 of this manual)



- Abort of control

After the test has been completed the test is summarized (see ch. 30.8) and the results are automatically saved in the database.

Caution:



A pattern and example of the report from estimating average tare are described in ch. 30.14 of this manual.

30.11.1. Abort of control - procedure

User may abort a control that is being carried out with internal criteria.

It may be done by pressing function key  (abort control) in any chosen moment. This key is located in the bottom part of a process window. When the key is pressed the following message is displayed.



Pressing  key means getting back to the control in progress. Pressing  key means abort of the control. Abort of control results in getting back to **PGC** mode setting window.

A report on control will be saved to < **Controls**> database, report's status - <**Terminated**>.

30.11.2. Procedure of control completion

Completion of control realized in accordance with internal criteria may be carried out in two ways:

- **Automatically**

All samples control – number of controlled samples accordant with declared value in **<Sample quantity>** parameter. On completion of the control a process summary is generated (see point 30.8 of this manual). The control is automatically saved to database.

- **Manually**

Pressing beforehand defined key  (finish the control). When the key is pressed the following message is displayed.



Pressing  key means getting back to the control in progress.

Pressing  key means finish of the control. Finish of control results in getting back to **PGC** mode setting window.

Caution:

Pattern and example of a report on control is described in point 30.14 of this manual.

30.12. Simultaneous carrying out two control processes

The scale enables carrying out two control processes at the same time. The option is enabled in:

- Go to local mode settings and set parameter  **Number of accessible controls** to value **2** (two controls),

- Change functions of the hot-keys for the following screens: home screen, settings and process screens. Enable hot-keys:

< **1** Set control 1 > and < **2** Set control 2 > for the above screens.

Entering the “**settings window**” of a control causes displaying data on a control identifying number of the enabled control:



Caution:

With a multiplatform scale, an operator using the parameter <  **Platform** > ma has the option of assigning platform number to the current control.

After entering required data on a control and starting the control process, the scale also displays data identifying the number of the enabled control:



Caution:

Processes:

- *Control carrying out,*
- *Logging out during control in progress,*
- *Control termination,*

are the same as in case of the above parts of this manual.

30.13. Report from estimating average tare

Report example:

Average Tare Report U/26/09/09/10/56/T

Balance Type: WPY KTP
Max: 1.5/3 kg
d=e: 0.5/1 g
Factory Number: 123589
Date: 2009.09.26 10:56:30
Product: AQUABA SAUCE
Tare: 7.9 g
Value 0.25T1: 3.75 g
Number of measurements: 10
Standard Deviation:
0.3162278

Test result: Positive

Weighments:

1. 8.5 g
2. 7.5 g
3. 8.0 g
4. 8.0 g
5. 8.0 g
6. 7.5 g
7. 7.5 g
8. 8.0 g
9. 8.0 g
10. 8.0 g

.....

Report pattern:

In submenu  **Printouts** users can edit the pattern of the average tare report (see ch. 16.2.3). The default pattern is shown below:

```
Average Tare Report {301}
-----
{40:Balance type:,-20}{44}
{40:Max:,-20}{34}
{40:d=e:,-20}{33}
{40:Factory number:,-20}{32}
{40>Date:,-20}{295}
{40:Product:,-20}{50}
{40:Tare:,-20}{54} g
{40:Value 0.25T1:,-20}{298} g
{40:Number of measurements:,-20}{299}
{40:Standard deviation:,-20}
{297}

{40:Result:,0}{296}

{40:Measurements:,-20}
{300}

.....
-----
{143:0c}
```

30.14. Report from product testing

Report example:

```
CPG Report U/26/09/09/10/59
-----
Balance Type:      WPY KTP
Max:               1.5/3 kg
d=e:               0.5/1 g
Factory Number:    123589
Start date:        2009.09.26 10:55:28
End date:          2009.09.26 10:59:53
Operator:          Jan Kowalski
Product:           AQUABA SAUCE
Batch Number:      123/09
```

Nominal Mass: 520 g
Tare: 7.9 g
T1 error border: 15 g
2T1 error border: 30 g
Batch quantity: 100
Number of measurements: 30
Number of T1 errors: 0
Number of 2T1 errors: 0
Min: 518 g
Max: 529.5 g
Average: 519.9833 g
Total: 15599.5 g
Limit of the average: 518.9138 g
Standard Deviation: 2.159515
CPG mode:
Non-destructive Average Tare

Result: Positive

Measurements:

1. 518.0 g
2. 520.5 g
3. 529.5 g
4. 520.0 g
5. 521.0 g
6. 518.0 g
7. 519.0 g
8. 519.0 g
9. 519.0 g
10. 521.0 g
11. 521.0 g
12. 521.0 g
13. 521.0 g
14. 520.0 g
15. 521.0 g
16. 518.0 g
17. 518.0 g
18. 518.0 g
19. 518.5 g
20. 518.5 g
21. 518.5 g
22. 519.0 g
23. 519.0 g
24. 519.0 g
25. 519.0 g
26. 521.0 g
27. 521.0 g
28. 521.0 g
29. 521.0 g
30. 521.0 g

.....

Report pattern:

In submenu  **Printouts** users can edit the pattern of the average tare report (see ch. 16.2.3). The default pattern is shown below:

```
CPG Report {279}
-----
{40:Balance type:,-20}{44}
{40:Max:,-20}{34}
{40:d=e:,-20}{33}
{40:Factory number:,-20}{32}
{40:Start date:,-20}{261}
{40:End date:,-20}{262}
{40:Operator:,-20}{75}
{40:Product:,-20}{50}
{40:Batch number:,-20}{260}
{40:Nominal Mass:,-20}{53}{278}
{40:Tare:,-20}{54}g
{40:T1 error border:,-20}{266}{278}
{40:2T1 error border:,-20}{267}{278}
{40:Batch quantity:,-20}{264}
{40:Number of measurements:,-20}{265}
{40:Number of T1 errors:,-20}{268}
{40:Number of 2T1 errors:,-20}{270}
{40:Min:,-20}{272}{278}
{40:Max:,-20}{273}{278}
{40:Average:,-20}{274}{278}
{40:Total:,-20}{271}{278}
{40:Limit of the average:,-20}{275}{278}
{40:Standard deviation:,-20}{276}
{40:CPG mode:,-20}
{58}

{40:Result:,0}{263}

{40:Measurements:,-20}
{277}



.....
-----
{143:0c}
```

31. WORKING MODES – DENSITY



Working mode < **Density**> enables determining density of solids, liquids and materials of high viscosity. The density is determined on basis of Archimedes principle, according to which any floating object displaces its own weight of fluid. The density mode also enables utilizing a pycnometer for determining density of liquids.





31.1. Starting the working mode









Procedure:

- While in main window of the software, press  on-screen key, located in the top bar of the window, which opens submenu <**Working Modes**> containing list of available working modes,
- Select working mode < **Density**>, the software automatically returns to displaying the main window, and the top bar indicates the icon of selected working mode,
- Simultaneously, the workspace of the display indicates a message: <**Start estimating density**>.

31.2. Local setting of a working mode

Local settings for the working mode < **Density**> are accessible on pressing a hot key < **Local parameters**>:

	Standard liquid	Function dedicated for determining the standard liquid. There are three options: water, alcohol and other. If option "other" is selected, then its density should be specified. In case of the other two types of liquids, their density values are implemented in the software
	Temperature	Parameter of the standard liquid inserted by the scale user. Declared temperature of the standard liquid automatically determines its density based on a table of liquid densities. In case of the liquid type "Other", the temperature parameter is not applicable, the density value is inserted manually
	Standard liquid density	Parameter designed for manual determining the density of standard liquid in [g/cm ³]
	Sinker volume	Parameter implemented for manual determining the volume of a sinker expressed [cm ³]

	Ask about sample number	Function ordering inserting number of a sample before initiating the test procedure
	Pycnometer mass	Parameter designed for manual determining mass of a pycnometer expressed in [g]. If inserted value is equal to „0” then on test procedure start, the pycnometer mass shall be measured.
	Pycnometer density	Parameter intended for manual determining volume of the pycnometer expressed in [cm ³]
	Unit	Weighing unit set to read the measurement result. This weighing unit is used for presenting measurement result, data in reports, databases and summaries.
	Save mode	Detailed description in ch. 24.2 of the user manual
	Checkweighing	Detailed description in ch. 24.4 of the user manual
	Tare mode	Detailed description in ch. 24.5 of the user manual
	Statistics	Detailed description in ch. 24.7 of the user manual

31.3. Carrying out density determination procedure

Working mode <  **Density**> enables determining density in 4 different methods, depending on material which density should be measured.





Methods of density determination: Liquid, Solids, Pycnometer, Porous material.

31.3.1. Determining density of liquids

Density of liquid is determined by measuring mass of a sinker with determined volume. First, the sinker has to be weighed in the air, and then in liquid of which the density should be measured.





The difference between the two measurements is displacement weight, which is used by scale software to calculate the density of tested liquid. Before starting the measurement, the sinker's volume should be inserted to scale's memory. The sinker's volume is given on its hook.

Process course:

- Press <  **Local parameters**> key to enter the setting of local parameters in density mode.
- Press <  **Sinker volume**> in order to insert the volume of the sinker (given in [cm³]) which is immersed in the tested liquid.
- On specifying the parameters exit to main menu of the density mode by pressing  key.
- In order to start density determination of liquid, press <  **Determine liquid density**> key, using a pre-defined hot keys on terminal's display.





Caution:

*If in the local parameters, <  **Ask about sample number**> function is enabled, then on initiating the process, the system asks for inserting the number of tested sample. The inserted sample number is linked to the process data and saved in the database.*







- The first phase of the density determination of liquid is measurement of sinker's mass in the air. Place the sinker on the scale's weighing platform. On obtaining stable measurement result, accept it by pressing  key.
- Next, place on scale's weighing platform tested liquid with immersed sinker. On obtaining stable measurement result, carry out the measuring process, and accept it by pressing  key.
- On carrying out the second measurement, the scale determines density of tested liquid and indicates the result on terminal's display. If the user needs a report from the density determination process, it can be printed on a plugged printer by pressing  key. The density determination process is then completed.
- A report from density determination of liquid is saved in <  **Density**> database. The report is named by process date.

31.3.2. Determining density of solids

Density of solids is determined by weighing a solid object in two different medium: in the air and in auxiliary liquid with determined density. The difference between the two measurements is displacement weight, which is used by scale software to calculate the density of tested solid.





Before starting the measurement select <  **Local parameters**> menu and choose <  **Standard liquid**> to be utilized in the density determination process. Also determine the temperature of the auxiliary liquid. Declaring the temperature of the auxiliary liquid enables matching its density to a table of liquid densities. In case of selecting liquid type "Other", its density value should be specified in parameter <  **Standard liquid density**>. Here, the <  **Temperature**> parameter is specified only for information purpose of the report.

Process course:

- Press <  **Local parameters**> key to enter the setting of local parameters in density mode.
- Press <  **Standard liquid**> key to select the auxiliary liquid used for the density determination procedure. If the auxiliary liquid is other than "Water" or "Alcohol", then select "Other" from the available list.
- Press <  **Temperature**> key and specify the temperature of the auxiliary liquid [°C]. Accept inserted value by pressing  key.
- If „Other" liquid has been selected, then press <  **Standard liquid density**> and insert the density value of the auxiliary liquid expressed in **[g/cm³]** for the specified temperature of the measurement.
- On specifying the parameters exit to main menu of the density mode by pressing  key.
- In order to start density determination of a solid, press <  **Determine solid density**> key, using a pre-defined hot keys on terminal's display.

Caution:

If in the local parameters, < **Ask about sample number**> function is enabled, then on initiating the process, the system asks for inserting the number of tested sample. The inserted sample number is linked to the process data and saved in the database.

- The first phase of the density determination of solid, is measurement of the solid object in the air. Place the object on the scale's weighing platform. On obtaining stable measurement result, accept it by pressing  key,
- Next, in the auxiliary liquid place scale's weighing platform with immersed tested solid object. On obtaining stable measurement result, carry out the measuring process, and accept it by pressing  key,
- On carrying out the second measurement, the scale determines density of tested solid and indicates the result on terminal's display. If the user needs a report from the density determination process, it can be printed on a plugged printer by pressing  key. The density determination process is then completed.
- A report from density determination of solids is saved in < **Density**> database. The report is named by process date.

31.3.3. Determining density of pycnometer









Pycnometer- it is a glass vessel which enables precise measurement of liquid mass at a precisely determined volume. A measurement method applying a pycnometer is one of the simplest means of determining density of liquids (densimetric method).

The key component of a pycnometer is a ground-in stopper with dumped capillary tube, which allows easy observation of the level of liquid contained in the vessel. Before the measurement process, the pycnometer is intentionally overfilled with tested liquid, then it is closed tightly with a stopper and thermally stabilized.

The excess of liquid pouring through the capillary tube is removed with an absorbent paper. Then, the vessel is immediately placed on a scale, and its mass is determined as quickly as possible. During the mass measurement, due to contraction of the volume of liquid its level usually decreases in the capillary tube, but this does not matter if at the time of placing instrument on the scale, it was completely filled and had correct temperature. Small diameter of the capillary tube prevents evaporation of the liquid from the vessel, and therefore it does not affect the measurement result.





Before starting the density determination using a pycnometer, data on its volume and mass should be inserted to scale's memory. If pycnometer's mass is not specified in the local parameters, than the process starts with determining mass of an empty pycnometer.

Process course:

- Press  **Local parameters**> key to enter the setting of local parameters in density mode.
- Press  **Pycnometer mass**> key to insert the mass of a pycnometer used for determining density of tested liquid. Pycnometer's mass is expressed in grams [g]. Accept inserted value by pressing  key.
- Press  **Pycnometer volume**> to specify the volume of the pycnometer used for determining density of tested liquid. The volume is expressed in grams [cm^3]. Accept inserted value by pressing  key.
- Press  **Temperature**> key and specify the temperature in which the test of liquid density determination is carried out. The temperature value is expressed in [$^{\circ}\text{C}$]. Accept inserted value by pressing  key. The temperature serves here for information purpose, and it is placed on reports from carried out processes.
- On specifying the parameters exit to main menu of the density mode by pressing  key.
- In order to start density determination using a pycnometer, press  **Determine pycnometer density**> key, using a pre-defined hot keys on terminal's display.

Caution:

If in the local parameters, <  **Ask about sample number** > function is enabled, then on initiating the process, the system asks for inserting the number of tested sample. The inserted sample number is linked to the process data and saved in the database.

- The first phase of density determination process is weighing a pycnometer (if its mass has been determined as “0” in the local parameters) – place an empty pycnometer on scale’s weighing platform. On obtaining stable measurement result, accept it by pressing  key. If mass of a pycnometer has been determined in parameter <  **Pycnometer mass** >, then this phase of the process is omitted,
- Then place on the scale’s weighing platform a pycnometer filled with liquid. On obtaining stable measurement result, carry out the measuring process, and accept it by pressing  key,
- On carrying out the measurement of the pycnometer with tested liquid, the scale determines the density of the liquid, and the density determination result is indicated on terminal’s display. If the user needs a report from the density determination process, it can be printed on a plugged printer by pressing  key. The density determination process is then completed,
- A report from density determination using a pycnometer is saved in <  **Density** > database. The report is named by process date.







31.3.4. Determining density of a porous body

Determining density of a porous body is carried out in three phases:

- Weighing a porous body in the air,
- Weighing in the air of a porous body impregnated with oil,
- Weighing in auxiliary liquid of a porous body impregnated with oil.



In case of porous objects, it is necessary to carry out an oil bath, which fills and closes the pores of the material before its actual weighing in the auxiliary liquid.



Process course:

- Press <  **Local parameters**> key to enter the setting of local parameters in density mode.
- Press <  **Standard liquid**> key to select the auxiliary liquid used for the density determination procedure. If the auxiliary liquid is other than “Water” or “Alcohol”, then select “Other” from the available list.
- Press <  **Temperature**> i key and specify the temperature of the auxiliary liquid [°C]. Accept inserted value by pressing  key.
- If „Other” liquid has been selected, then press <  **Standard liquid density**> insert the density value of the auxiliary liquid expressed in [g/cm³] for the specified temperature of the measurement.
- On specifying the parameters exit to main menu of the density mode by pressing  key.
- In order to start density determination of porous body, press <  **Determine porous body density**> key, using a pre-defined hot keys on terminal's display.

Caution:

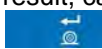
*If in the local parameters, <  **Ask about sample number**> function is enabled, then on initiating the process, the system asks for inserting the number of tested sample. The inserted sample number is linked to the process data and saved in the database.*

- The first phase of the density determination of a porous body in the air. Place the object on the scale's weighing platform. On obtaining stable measurement result, accept it by pressing  key,
- Then immerse the tested porous body in oil to fill its pores. Place the tested porous body impregnated with oil on scale's weighing platform. On obtaining stable measurement result, carry out the measuring process, and accept it by pressing  key,
- In the third step, weight the tested porous object impregnated with oil in the auxiliary liquid. Place the tested object in the auxiliary liquid, on scale's weighing platform and immerse both in the auxiliary liquid. On obtaining stable measurement result, carry out the measuring process, and accept it by pressing  key,

- On carrying out the third measurement, the scale automatically determines the density of the porous body, and indicates the result on terminal's display. If the user needs a report from the density determination process, it can be printed on a plugged printer by pressing  key. The density determination process is then completed,
- A report from density determination of a porous body is saved in  **Density** database. The report is named by process date.

31.4. Reporting from completed density determination processes

On completing each density determination process, the scale's software automatically generates a report.

Caution:

Submenu:  **Devices** /  **Printer** /  **Printouts** /  **Density printout template**" enables optional configuration of report template (see ch. 16.2.3 of this user manual).

Default form of the report from density determination template:

```

-----
Density
-----
{40:Operator:,-25}{75}
{40:Start date:,-25}{155}
{40:End date:,-25}{156}
{40:Standard liquid:,-25}{158}
{40:Method:,-25}{157}
{40:Weighing 1:,-25}{165}
{40:Weighing 2:,-25}{166}
{40:Density:,-25}{162}{163}
-----

```

The report from each completed density determination process is simultaneously saved in the database of  **Density Reports**, where the files are named by their date and hour of process execution. List of data for the density determination process – see ch. 35.5.4 of this user manual.

31.5. Table of density parameter for water

T/°C	0.0	0.1	0.2	0.3	0.4	0.5	0.6	0.7	0.8	0.9
10.	0.99973	0.99972	0.99971	0.99970	0.99969	0.99968	0.99967	0.99966	0.99965	0.99964
11.	0.99963	0.99962	0.99961	0.99960	0.99959	0.99958	0.99957	0.99956	0.99955	0.99954
12.	0.99953	0.99951	0.99950	0.99949	0.99948	0.99947	0.99946	0.99944	0.99943	0.99942
13.	0.99941	0.99939	0.99938	0.99937	0.99935	0.99934	0.99933	0.99931	0.99930	0.99929
14.	0.99927	0.99926	0.99924	0.99923	0.99922	0.99920	0.99919	0.99917	0.99916	0.99914
15.	0.99913	0.99911	0.99910	0.99908	0.99907	0.99905	0.99904	0.99902	0.99900	0.99899
16.	0.99897	0.99896	0.99894	0.99892	0.99891	0.99889	0.99887	0.99885	0.99884	0.99882
17.	0.99880	0.99879	0.99877	0.99875	0.99873	0.99871	0.99870	0.99868	0.99866	0.99864
18.	0.99862	0.99860	0.99859	0.99857	0.99855	0.99853	0.99851	0.99849	0.99847	0.99845
19.	0.99843	0.99841	0.99839	0.99837	0.99835	0.99833	0.99831	0.99829	0.99827	0.99825
20.	0.99823	0.99821	0.99819	0.99817	0.99815	0.99813	0.99811	0.99808	0.99806	0.99804
21.	0.99802	0.99800	0.99798	0.99795	0.99793	0.99791	0.99789	0.99786	0.99784	0.99782
22.	0.99780	0.99777	0.99775	0.99773	0.99771	0.99768	0.99766	0.99764	0.99761	0.99759
23.	0.99756	0.99754	0.99752	0.99749	0.99747	0.99744	0.99742	0.99740	0.99737	0.99735
24.	0.99732	0.99730	0.99727	0.99725	0.99722	0.99720	0.99717	0.99715	0.99712	0.99710
25.	0.99707	0.99704	0.99702	0.99699	0.99697	0.99694	0.99691	0.99689	0.99686	0.99684
26.	0.99681	0.99678	0.99676	0.99673	0.99670	0.99668	0.99665	0.99662	0.99659	0.99657
27.	0.99654	0.99651	0.99648	0.99646	0.99643	0.99640	0.99637	0.99634	0.99632	0.99629
28.	0.99626	0.99623	0.99620	0.99617	0.99614	0.99612	0.99609	0.99606	0.99603	0.99600
29.	0.99597	0.99594	0.99591	0.99588	0.99585	0.99582	0.99579	0.99576	0.99573	0.99570
30.	0.99567	0.99564	0.99561	0.99558	0.99555	0.99552	0.99549	0.99546	0.99543	0.99540

31.6. Table of density parameter for ethyl alcohol



T/°C	0.0	0.1	0.2	0.3	0.4	0.5	0.6	0.7	0.8	0.9
10.	0.79784	0.79775	0.79767	0.79758	0.79750	0.79741	0.79733	0.79725	0.79716	0.79708
11.	0.79699	0.79691	0.79682	0.79674	0.79665	0.79657	0.79648	0.79640	0.79631	0.79623
12.	0.79614	0.79606	0.79598	0.79589	0.79581	0.79572	0.79564	0.79555	0.79547	0.79538
13.	0.79530	0.79521	0.79513	0.79504	0.79496	0.79487	0.79479	0.79470	0.79462	0.79453
14.	0.79445	0.79436	0.79428	0.79419	0.79411	0.79402	0.79394	0.79385	0.79377	0.79368
15.	0.79360	0.79352	0.79343	0.79335	0.79326	0.79318	0.79309	0.79301	0.79292	0.79284
16.	0.79275	0.79267	0.79258	0.79250	0.79241	0.79232	0.79224	0.79215	0.79207	0.79198
17.	0.79190	0.79181	0.79173	0.79164	0.79156	0.79147	0.79139	0.79130	0.79122	0.79113
18.	0.79105	0.79096	0.79088	0.79079	0.79071	0.79062	0.79054	0.79045	0.79037	0.79028
19.	0.79020	0.79011	0.79002	0.78994	0.78985	0.78977	0.78968	0.78960	0.78951	0.78943
20.	0.78934	0.78926	0.78917	0.78909	0.78900	0.78892	0.78883	0.78874	0.78866	0.78857
21.	0.78849	0.78840	0.78832	0.78823	0.78815	0.78806	0.78797	0.78789	0.78780	0.78772
22.	0.78763	0.78755	0.78746	0.78738	0.78729	0.78720	0.78712	0.78703	0.78695	0.78686
23.	0.78678	0.78669	0.78660	0.78652	0.78643	0.78635	0.78626	0.78618	0.78609	0.78600
24.	0.78592	0.78583	0.78575	0.78566	0.78558	0.78549	0.78540	0.78532	0.78523	0.78515
25.	0.78506	0.78497	0.78489	0.78480	0.78472	0.78463	0.78454	0.78446	0.78437	0.78429
26.	0.78420	0.78411	0.78403	0.78394	0.78386	0.78377	0.78368	0.78360	0.78351	0.78343
27.	0.78334	0.78325	0.78317	0.78308	0.78299	0.78291	0.78282	0.78274	0.78265	0.78256
28.	0.78248	0.78239	0.78230	0.78222	0.78213	0.78205	0.78196	0.78187	0.78179	0.78170
29.	0.78161	0.78153	0.78144	0.78136	0.78127	0.78118	0.78110	0.78101	0.78092	0.78084
30.	0.78075	0.78066	0.78058	0.78049	0.78040	0.78032	0.78023	0.78014	0.78006	0.77997

32. WORKING MODES – ANIMAL WEIGHING

Working mode < **Animal weighing**> enables weighing objects which do not stabilize if placed on scale's weighing platform and while carrying out weighing process. Weighing process is achieved by implementing parameter of time for stability of measurement, which is set in global parameters of the working mode. This working mode is mainly utilized for weighing different kinds of animals. The mode may be controlled automatically or manually – i.e. the weighing process is triggered manually or automatically.

32.1. Starting the operating mode

Procedure:





- While in main window of the software, press  on-screen key, located in the top bar of the window, which opens submenu <**Working Modes**> containing list of available working modes,
- Select working mode < **Animal weighing**>, the software automatically returns to displaying the main window, and the top bar indicates the icon  of selected working mode,
- Simultaneously, an additional hot key is activated on the far right side of the bottom tool bar:





Start animal weighing process





32.2. Local setting of a working mode

Local settings for the working mode < **Animal weighing**> are accessible on pressing a hot key < **Local parameters**>:

	Checkweighing	Detailed description in ch. 24.4 of the user manual
	Tare mode	Detailed description in ch. 24.5 of the user manual
	Labelling mode	Detailed description in ch. 24.6 of the user manual
	Statistics	Detailed description in ch. 24.7 of the user manual

	Averaging time	Declaration of process duration in seconds (from 1s to 90s) – measurements carried out in set time interval are used to calculate mean value, which is the result of the measurement
	Automatic mode	Operation mode, in which the scale automatically begins the following measuring process, if the load placed on scale's weighing platform exceeds value of mass set in LO threshold.

32.3. Carrying out animals weighing procedure

- Enter the working mode <  **Animal weighing** > according to ch. 32.1 of this user manual,
- Should the tested animal be weighed in a container, load the container of scale's weighing platform and tare its mass,
- On placing the tested animal on the scale's weighing platform (in the tarred container), press  key (Process start), which displays a message box indicating course of the process,
- The message box contains data on:
 - Progress bar indicated in %,
 - Value of averaging time interval, set in local parameters,
 -  key enabling aborting the process,
- On completing the measuring process, the value of measured result is locked in the message box,
- Confirm completing the process by pressing  key.

33. WORKING MODE – VEHICLE SCALE

Working mode <  **Vehicle Scale** > enables weighing trucks, determining mass of loads based on weighments carried out on entering and exiting a weighbridge.

33.1. Working mode activating procedure

- When in the main software window press  pictogram located in the top bar of the display which opens a submenu **<Working modes>** containing list of available working modes,

- Select working mode < **Vehicle Scale**>, the software automatically returns to the main window:

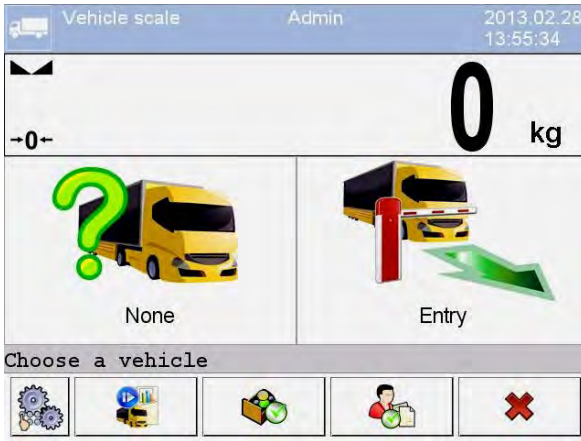

Where:



Select a vehicle



Default transaction type



Local parameters of a working mode



Select an open transaction



Select a product





Select a client



Abort an ongoing transaction

33.2. Working mode local settings

The local settings of working mode < **Vehicle Scale**> are accessed by pressing an hot-key < **Local settings**>:

	Default transaction type	Selecting a default transaction type. Available settings: Entrance, Exit, Control weighment.
	Select vehicle	Declaring the means for selecting a vehicle. Available options: From list, From hand, By name, By code.
	Print report	Enabling automatic report printout on completing a vehicle transaction.

33.3. Vehicle transaction course

Starting a vehicle transaction, requires that a logged operator features appropriate access level for carrying out the transaction.

Caution:

In order to start a transaction, the access level of a logged user must be at least <operator>. IF the logged user or anonymous user feature access level <none> then on starting a transaction the software displays a message: <No authorization>.

An operator can carry out three types of transactions:

- Entrance,
- Exit,
- Control weighment.

33.3.1. Entrance / Exit transaction

Changes of transaction type are carried out by pressing , where:



Entrance transaction



Exit transaction

Procedures for carrying out an entrance transaction and an exit transaction are the same, therefore the further part of the user manual contains description of an entrance transaction only.

Before starting a transaction enter to scale memory general parameters of the working mode (see point 33.2 of this user manual).

Procedure:

- Press hot-key  to select a required vehicle, which opens the following window:

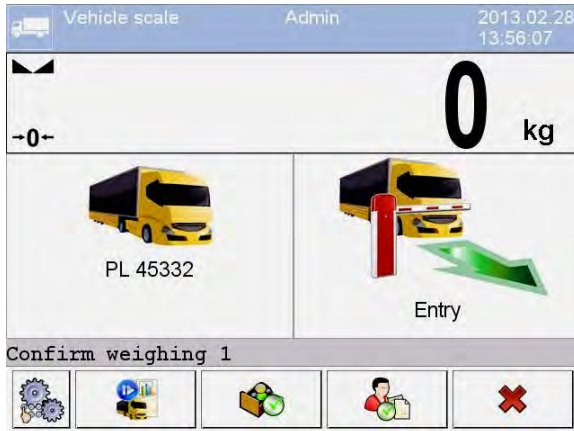

Where:



PL 45332

- A vehicle with saved registration number



Entry



- Transaction type (entrance)

Confirm weighing 1

- A message for an operator. The scale waits for accepting the weighing on entrance

Caution:

1. Additionally, an operator can:

- Assign a product to a transaction by pressing  button,
- Assign a client to a transaction by pressing  button.

2. Before starting a transaction, first an operator should select a vehicle to be weighed. Otherwise the scale displays a message

<  **Vehicle not selected** >

- After the vehicle enters onto the weighbridge (entrance), and stabilizing of the measuring result, accept the measurement by pressing **ENTER/PRINT** button, which opens the following window:

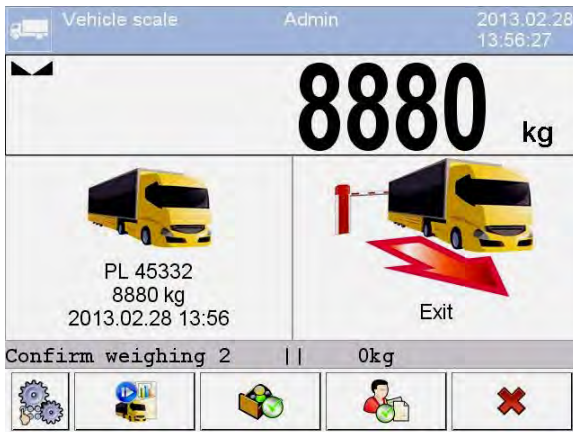

Where:



PL 45332
8880 kg
2013.02.26 8:37

- A vehicle with saved registration number, accepted mass on entrance and time and date of entrance weighing



Exit

- Transaction type (exit)

Confirm weighing 2

- Message for an operator. The scale waits for accepting the exit weighment

0 kg



- Mass of the load

- At the same time, a printer connected to the scale prints an **“Entrance ticket”**.

Caution:

A default format of an „Entrance ticket” template is described in point 33.5 of this user manual.

- After the same vehicle enters onto the weighbridge (entrance) and stabilizing of measurement result, accept the measurement by pressing **ENTER/PRINT** button which opens a process summary window:

Report of vehicle transaction		
		
PL 45332 ----- ----- -----	8880 kg 2013.02.28 13:56	18880 kg 2013.02.28 18:57
Load mass: 10000 kg		
<input checked="" type="checkbox"/> <input type="checkbox"/>		

Caution:

The non-declared transaction items are represented by dashes, correspondingly denoting:

- *Missing code assigned to a vehicle,*
 - *Missing product assigned to a transaction,*
 - *Missing client assigned to a transaction.*
- At the same time, a printer connected to the scale prints a ticket **“Exit ticket”**.

Caution:

1. *In case of declaring an automatic printout of a report, on completing a vehicle transaction the scale orders printing a “Report from Vehicle Scale” together with the printout of the “Exit ticket”.*
 2. *A default format of the printout template of the “Exit ticket” and a “Report from Vehicle Scale” are described in point 33.5 of this user manual.*
- After accepting the summary window of the “Report from Vehicle Transaction” the software automatically returns to the main window.

33.3.2. Control weightment transaction

Changes of transaction type are carried out by pressing , where:

-  Entrance
-  Exit
-  Control weightment



Before starting a transaction enter to scale memory general parameters of the working mode (see point 33.2 of this user manual).

Procedure:

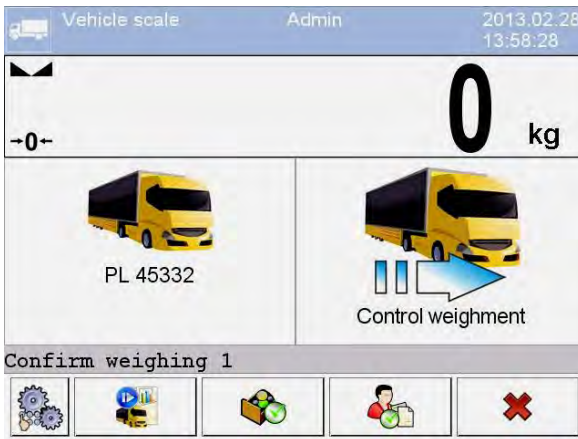
- Press hot-key  to select a required vehicle, which opens the following window:





Where:



-  - A vehicle with saved registration number
PL 45332
-  - Transaction type (control weightment)
Control weightment

Confirm weighing 1 - A message for an operator. The scale waits for accepting the control weighing

Caution:

Additionally, an operator should determine:

- Assign a product to a transaction by pressing  button,
 - Assign a client to a transaction by pressing  button,
- After the vehicle enters onto the weighbridge (control weighing) and stabilizing of the measuring result, accept the measurement by pressing **ENTER/PRINT** button, which opens a window on process summary:

Report of vehicle transaction	
	
PL 45332 ----- ----- -----	8880 kg 2013.02.28 13:58 Load mass: ---
	

Caution:

The non-declared transaction items are represented by dashes, correspondingly denoting:

- Missing code assigned to a vehicle,
 - Missing product assigned to a transaction,
 - Missing client assigned to a transaction,
 - Missing value of load mass.
- At the same time, a printer connected to the scale prints a ticket **“Control weighing ticket”**.

Caution:

A default format of the printout template of the **“Control weighing ticket”** is described in point 33.5 of this user manual.

- After accepting the summary window of the “Report from Vehicle Transaction” the software automatically returns to the main window.

33.4. Open transactions table

A scale user is able to start an optional number of transactions at the same time. All opened (unfinished) transactions are temporarily saved in the “**table of opened transactions**”. A list of opened transactions to be completed is

accessed by pressing a hot-key  located in the bottom bar of the scale display.

Caution:

If a user attempts to choose a vehicle for which a transaction is already opened, then the software displays a message box:



33.5. Printout templates for an ongoing transaction

During ongoing vehicle transaction the user can print transaction tickets (reports) with the use of a printer connected to the scales.

List of standard printouts for „Vehicle scales” operating mode:

- Entrance Ticket Printout Template
- Exit Ticket Printout Template
- Control Weighment Ticket Printout Template
- Report from Vehicle Scale Printout Template:

Default content of printout templates:

<p>Entrance Ticket Printout Template:</p>	<p>----- Entrance ticket ----- {40:Date:,-20}{4} {40:Vehicle:,-20}{210} {40:Mass on entrance:,-20}{7}{11} ----- Signature..... -----</p>
<p>Exit Ticket Printout Template:</p>	<p>----- Exit ticket ----- {40: Date:,-20}{4} {40: Vehicle:,-20}{210} {40: Mass on exit:,-20}{7}{11} ----- Signature..... -----</p>
<p>Control Weighment Ticket Printout Template:</p>	<p>----- Control weighment ticket ----- {40: Date:,-20}{4} {40: Vehicle:,-20}{210} {40: Mass:,-20}{7}{11} ----- Signature..... -----</p>
<p>Report from Vehicle Scale Printout Template:</p>	<p>----- Report from Vehicle Scale ----- {40:Start date:,-20}{213} {40:End date:,-20}{214} {40:Vehicle:,-20}{210} {40:Mass on entrance:,-20}{215}{11} {40:Mass on exit:,-20}{216}{11} {40:Mass of load:,-20}{217}{11} ----- Signature..... -----</p>

Caution:

„  /  **Devices** /  **Printer** /  **Printouts**” submenu user can freely modify printout standards (see point 16.2.3 of this manual).

33.6. Executed transactions – reporting

Each completed transaction is automatically saved and stored in the database of < **Reports from Vehicle Scale**>.

Each database record features the following data:

- Vehicle registration number,
- Transaction type (entrance, exit or control weighing),
- Transaction status (loading or unloading).

Additionally, the type and status of a transaction are marked by a corresponding colour:

Green	– Transaction completed successfully
Yellow	– Transaction not completed
Red	– Transaction aborted

Detailed list of data for an executed vehicle transaction – see point 35.5.7 of this manual.

34. DATABASES

Scale databases hold different data:

	Products
	Operators
	Clients
	Dosing processes
	Formulations
	Vehicles
	Identification processes
	Time Schedule PGC
	Packages

	Warehouses
	Labels
	Universal variables
	Extra variables
	Images

In order to enter  **Databases**>, press  and choose  **Databases**>.

34.1. Database configuration.



 **Databases configuration**> submenu enables the user to:

- Set databases availability
- Categorize product
- Declare data operation for databases: product, operators, clients, extra variables
- Change databases records preview
- Import databases from a memory stick to the scale
- Export databases to a memory stick

Caution:

Configuration can be executed by a user with “Administrator” authority.

34.1.1. Databases accessibility

  **Databases accessibility**> submenu allows to declare databases which are to be available for the user.

Procedure:

- Enter submenu: „ **Databases** /  **databases configuration**”, according to ch. 34 of this manual,
- Choose   **Databases accessibility**> to view a list of available databases.



Where:









- Accessible database
- Inaccessible database

34.1.2. Categories



< **Categories**> serves to divide product databases into folders (categories) in order to optimally group particular records.

To operate product categories < **Product categories**> parameter needs to be activated. The parameter is located in „ **Databases configuration**  / **categories**” submenu.

How to create databases categories – procedure:

- Enter „ **Databases configuration** /  **Categories** /  **Database of categories**”,
- Press  button to see <**Create new record?**> message.
- Press  button to confirm, the program will automatically edit the new position field.
- Edit the < **Name**> position and write a desired name of the category.

Procedure of assigning a product to a category

- Following point 34 of this manual enter < **Databases**>,
- Enter < **Products**> database and choose a demanded record,
- Chose < **Category**> position to open categories that have already been created,
- Choose a demanded position and exit in order to start weighing.

Caution:

*Product that haven't been given a category are automatically located in a folder < **Not assigned**>.*

34.1.3. Database variables operation

The user can turn on/off operation of database variables for:

- Product database,
- Operators database,
- Clients database.

Procedure:

- Enter <  **Database configuration**> submenu,
- Choose a demanded database to view a list of variables with accessibility attribute.

Where:



- Accessible variable



- Inaccessible variable



- Set accessibility of a demanded variable and exit in order to start weighingment.

34.1.4. Change name of an extra variables database

The user can change a name of an extra variables chart (table) in the following cases:

- When using programmable buttons <**Choose an extra variable**>,
- When using < **Choose an extra variable from database**> function during an identification process.



Procedure:

- Enter submenu: „  **Databases configuration /  Extra variables**”,
- Assign to a demanded variable the name of a database which will be shown when the above mentioned function is in use.

34.1.5. Change database records preview

< **Records preview**> submenu allows to swap between two different views of the displayed records: „**list**” or „**tiles**”.

Procedure:

- Enter submenu: „ **Databases configuration** /  **Records preview**”,
- Change records view for a demanded database.



Where:

-  - List
-  - Tiles



34.1.6. Databases export / import

The user can export/import all databases with the use of a memory stick.

Database export procedure:



- Put a memory stick into USB port of a scale,
- Enter: „ **Database configuration** /  **Export**” submenu to start automatic database export from scales to a memory stick.
- After the procedure has been completed a following message is displayed „**Operation completed successfully**”.

Database import procedure:

- Put a memory stick into USB port of a scale,
- Enter: „ **Database configuration** /  **Import**” submenu to start automatic database import from a memory stick.
- After the procedure has been completed a following message is displayed „**Operation completed successfully**”.





34.2. Searching databases

Users can quickly search databases according to the following criteria:

-  Name,
-  Code.





34.2.1. Quick name search

Procedure:

- Enter  **Databases**> according to ch. 34 of this manual,
- Enter  **Products**> ,
- Press  , then an editing field appears **<Search by name>** with the screen keyboard,
- Inscribe the name of a product or its part and press .
- The program will automatically edit the required product.





34.2.2. Quick code search

Procedure:

- Enter  **Databases**> according to ch. 34 of this manual,
- Enter  **Products**> ,
- Press  , then an editing field appears **<Search by code>** with the screen keyboard,
- Inscribe the name of a product or its part and press .
- The program will automatically edit the required product.

34.3. Adding new items in databases

Procedure:



- Enter  **Databases**> according to ch. 34 of this manual,
- Enter database  **Products**> ,
- Press  , then the message is displayed: **<Create new record?>**,
- Confirm it by pressing  , the program automatically enters edit window of a new record.

Caution:

Adding new records in databases is possible only by logged-in administrators.

34.4. Deleting items in databases

Procedure:

- Enter  **Databases**> according to ch. 34 of this manual,
- Enter  **Products**> ,
- Give a long press to the item, then the context menu is displayed,
- Press **<Delete>**, then a message is displayed: **<Are you sure you want to delete?>**,
- Confirm it by pressing  .



Caution:

Deleting records in databases is possible only by logged-in administrators.

34.5. Printing items from databases

Users can print any record in databases.

Procedure:

- Enter the submenu  **Databases**> according to ch. 34 of this manual,
- Enter  **Products**> and press the required item,

- After editing the required record press  in the top bar of the display,
- If a printer is connected information about the selected product is printed.

Caution:

Default printout templates for printing records from different databases are described in ch. 16.2.3 of this manual.

34.6. Context menu

Context menu enables the user to a quick access to database functions. Pressing a demanded database element (submenu) for about 2 seconds is required in order to activate a context menu.

Context menu for each of the databases displays the following list of functions:



Where:

Open	Opening a content of a folder
Import	Import of a database from a memory stick to a scale
Export	Export of a database to a memory stick
Delete all	Deleting all records of a particular database
Cancel	Cancelling (turning off) the context menu

The following list of functions will be displayed after activation of a context menu for one of a given database records:

Edit
Delete
Print
Copy
Cancel

Where:



Edit	Edit record
Delete	Delete record
Print	Printout of information about a record
Copy	Make a record copy
Cancel	Cancel (turn off) the context menu

34.7. Database edit window





The database edition can be performed by an administrator.





34.7.1. Operators' database

Procedure:

- Enter < **Databases**> according to ch. 34 of this manual,
- Enter < **Operators**> and press the required position.



Record of operator:

	Name	Operator name
	Code	Operator code
	Password	Password to log on (max. 16 characters)
	Access level	Authorization access level
	Card number	Transponder card reader for Logging on











		Working modes	Assigning a working mode to an operator
		Automatically	Automatic mode: Logging of a user automatically enables a working mode recently enabled by this user
		Change working mode	Permanent assigning a specific working mode to a logged operator. Setting “None” disables the function.
		Identification process	Assigning an identification process to a logging operator





















34.7.2. Database of products

Procedure:

- Enter < **Databases**> according to ch. 34 of this manual,
- Enter < **Products**> and press the required position.

Product record:



	Name	Product name
	Code	Product code
	EAN code	Product barcode
	Mass ¹⁾	Nominal product mass
	Mass for fast dosing	Mass of an ingredient for bulk dosing (in case of two-step dosing process)
	Batching outputs ²⁾	Declaring numbers of outputs for fine dosing
	Bulk batching output ²⁾	Declaring numbers of outputs for bulk dosing
	Correction 1 ²⁾	Value of dosing correction for weighing platform no. 1
	Correction 2 ²⁾	Value of dosing correction for weighing platform no. 2
	Correction 3 ²⁾	Value of dosing correction for weighing platform no. 3
	Correction 4 ²⁾	Value of dosing correction for weighing platform no. 4

	Maximum correction value ²⁾	Maximal value of dosing correction
	Min ³⁾	Minimum mass for checkweighing
	Max ³⁾	Maximum mass for checkweighing
	Deviation type ⁴⁾	Declaring deviation type: measuring unit of a value in [%]
	Low deviation ⁴⁾	Low deviation from mass (mass of an ingredient in a formulation)
	High deviation ⁴⁾	High deviation from mass (mass of an ingredient in a formulation)
	Tare	Tare value (it is pre-set automatically after selecting a product)
	Price	Unit price
	Currency	Currency assigned to a product price
	CPG mode ⁵⁾	Submenu with data declared in the working mode CPG (see ch. 30.4 of this manual)
	Number of validity dates	Number of days to calculate expiry date
	Additional days of expiry period	Offset of number of days of assortment expiry date
	Date	Constant product date
	VAT	Value Added Tax in [%]
	Ingredients	Dialogue box for entering ingredients
	Label	Basic label template attributed to a product
	C Label	Cumulative label template attributed to a product
	CC Label	Cumulative of cumulative label template attributed to a product
	Category	Category assigned to a product
	Image	Graphic (image) assigned to a product
	Identification process	Identification process assigned to a product









- 1) – Variable name dependant on an enabled working mode. In case of working modes: Weighing, Dosing, Formulation, Density, Animal weighing the variable takes the name: “**Mass**”. In case of the working mode “Parts counting” the variable takes the name: “**Part mass**”. In case of the working mode “Percent setup (Deviations)” the variable takes the name “**Standard mass**”.
- 2) – The variables accessible only in the working mode “**Dosing**”.
- 3) – The variable inaccessible for a product in the working mode “**Formulation**”.
- 4) – The variables accessible for a product only in the working mode “**Formulation**”.
- 5) – The variables accessible for a product only in the working mode “**CPG**”.

34.7.3. Database of clients

Procedure:

- Enter < **Databases**> according to ch. 34 of this manual,
- Enter < **Client**> and press the required position.

Client records:

	Name	Client's name
	Code	Client's code
	Tax ID	Client's tax ID
	Address	Client's address
	Postal code	Client's postal code
	City	Client's Town/City
	Discount	Client's discount
	Label	Client's label template







34.7.4. Database of dosing processes

Procedure:

- Enter < **Databases**> according to ch. 34 of this manual,

- Enter <  **Dosing processes**> and press the required position.



List of data for a selected dosing process:

	Name	Dosing process name
	Code	Dosing process code
	Platform 1	Weighing platform no. 1 determined for a specific terminal
	Platform 2 *	Weighing platform no. 2 determined for a specific terminal
	Platform 3 *	Weighing platform no. 3 determined for a specific terminal
	Platform 4 *	Weighing platform no. 4 determined for a specific terminal







*) – number of weighing platforms depends on determined data in the terminal settings

34.7.5. Database of formulations

Procedure:

- Enter <  **Databases**> according to ch. 34 of this manual,
- Enter <  **Formulations**> and press the required position.



List of data for a specific formulations:

	Name	Formulation name
	Code	Formulation code
	Ingredients	Defining ingredients of a formulation
	Number of ingredients	Previewing number of created ingredients in a formulation
	Formulation mass	Previewing total mass of a formulation
	Type of charge	Type of measuring charge of a formulation





	Charge	Measuring charge of a formulation
-----------------------------------------------------------------------------------	---------------	-----------------------------------

34.7.6. Database of PGC schedules

Procedure:



- Enter < **Databases**> according to ch. 34 of this manual,
- Enter < **Time Schedules PGC**> and press the required position.

List of data for selected PGC schedule:



	Product	Assigning product to PGC schedule
	Batch size	Specifying controlled batch quantity for PGC schedule
	Date	Specifying PGC schedule start date
	Cyclic control	Activating cyclic control
	Interval [min]	Specifying time interval in [min] for cyclic control



34.7.7. Database of vehicles

Procedure:

- Enter < **Databases**> according to ch. 34 of this manual,
- Enter < **Vehicles**> and press the required position.

List of data definable for a vehicle:



	Name *	Name of a vehicle (registration number)
	Code	Vehicle code

	Tare	Vehicle tare value (set automatically when selecting a vehicle record from the database)
	Card no.	Transponder card number for selecting a vehicle
	Description	Additional vehicle description





*) – When declaring means of selecting a vehicle “**From hand**”, entering a new registration number causes automatic adding a new vehicle record to the database with a name corresponding to the registration number.

34.7.8. Database of identification processes

Procedure:



- Enter <  **Databases**> according to ch. 34 of this manual,
- Enter <  **Identification processes**> and press the required position.

List of data for a selected identification process:

	Name	Identification process name
	Code	Identification process code
	Repeat the process	Enables an already initiated identification process to be performed in a cyclic manner
	Process creator	Submenu used for defining (creating) an identification process

34.7.9. Database of packages

Procedure:

- Enter <  **Databases**> according to ch. 34 of this manual,
- Enter <  **Packages**> and press the required position.

Package record:

	Name	Package name
	Code	Package code
	Mass	Package weight (set automatically after choosing after choosing a package from the database)

34.7.10. Database of warehouses

Procedure:

- Enter < **Databases**> according to ch. 34 of this manual,
- Enter < **Warehouses**> and press the required position.

Warehouse record:

	Name	Warehouse name
	Code	Warehouse code
	Description	Additional warehouse description







34.7.11. Database of labels

The database comprises templates of labels which users can attribute to products or clients to operate in labelling mode.

Procedure of editing databases:





- Enter < **Databases**> according to ch. 34 of this manual,
- Enter < **Labels**> and press the required position.



Label record:

	Name	Label name
	Code	Label code
	Label template*	Label printout template
	Printer 1	Printer 1 printout declaration (default setting)
	Printer 2	Printer 2 printout declaration
	Printer 3	Printer 3 printout declaration

*) *Ways of designing and sending templates to a scale can be found in **APPENDIX C** of this manual.*

34.7.12. Database of universal variables



The database includes templates of general purpose variables which user can attribute to screen function buttons  **Var 1**,  **Var 2**,  **Var 3**,  **Var 4**,  **Var 5** in order to enter any alphanumeric text intended to be printed.

Additionally values of three first universal variables  **Var 1**,  **Var 2**,  **Var 3** are stored in scales storage. If edited they will be saved in a record of an executed weighingment.



Caution:

The procedure of attributing functions to buttons is described in ch. 17.2 of this manual.

Procedure of editing databases:





- Enter  **Databases**> according to ch. 34 of this manual,
- Enter  **Var Universal variables**> and press the required position.

Universal variable record:

	Code	Universal variable code
	Name	Universal variable name, used for printout and/or for a weighment record
	Value	Universal variable value used for printout and/or for a weighment record

34.7.13. Extra variables database

The database includes templates of extra variables which user

can attribute to screen function buttons  **1**,  **2**,  **3**,  **4**,  **5** in order to enter any alphanumeric text intended to be printed.







Caution:

Procedure of defining screen function buttons is described in point 17.2 of this manual.

34.7.14. Images database

The database contains graphics that can be assigned to particular records of < **Products**> database.

Creating a new record - procedure:

- Put a memory stick into USB port of a scale,
- Following point 34 of this manual enter: „ **Database /**  **Images**”,
- Press  button to see <**Create new record?**> message,
- Press  button to confirm, the program will automatically edit the new position.
- Enter < **Name**> field and give a demanded name to a graphic.
- Select < **Image**> option to open the main folder of a memory stick,

Choose the demanded graphic file. The program will automatically return to the previous submenu. The chosen graphic and name will be displayed in a

< **Image**> field









Caution:



Maintained file formats are *.jpg, *.png, with the optimal (max.) resolution of 150x150 pixels, where:

- for a list record view an optimal resolution is 57x57 pixels;
- for a tile record view an optimal resolution is 133x133 pixels;

35. REPORTS

Software enables the following reports:

-  Weighments / Alibi
-  Reports from dosing
-  Reports from recipes
-  Controls Reports
-  Average tare reports
-  Vehicle scale reports
-  Density reports
-  Differential weighments reports

To enter < **Reports**> menu press  button, which is located in the window of the terminal, and choose < **Reports**> option.

35.1. Reports configuration



Submenu < **Report configuration**> allows for:

- declaration of reports, which are to be accessible for the user,
- configuration of lot number and batch number,
- activating option < **Ask for number of weighings to be deleted**>.



35.1.1. Reports accessibility

Submenu < **Reports accessibility**> allows for declaration of reports that are to be accessible for the user.

Procedure:



- Enter submenu < **Reports**> according to ch. 35 of this manual,
- Select < **Reports accessibility**> to view a list of reports with the accessibility attribute.

Where:



-  - Accessible report
-  - Inaccessible report

35.1.2. Configuration of a lot number

Procedure:



- Enter submenu: „ **Reports** /  **Reports configuration**” according to ch. 35 of this manual,
- Select <**00285 Lot number**> and carry out the configuration.

List of data definable for a lot number:



	Name	Change of the lot number name
	Template	Lot number template, allows using variables that are intended for a printout

35.1.3. Configuration of a batch number

Procedure:

- Enter submenu: „ **Reports /**  **Reports configuration**” according to ch. 35 of this manual,
- Select **<12ABC Batch number>** and carry out the configuration.

List of data definable for a batch number:

	Name	Change of the batch number name
	Template	Batch number template, allows using variables that are intended for a printout





35.1.4. Query for number of weighings to be deleted

The user with Administrator permissions level can delete (undo) recently performed weighings using programmable button: **< Undo weighing>**.

< Reports configuration> submenu additionally allows to declare how many weighings are to be deleted. In order to specify number of weighings that are to be subjected to deletion process it is necessary to activate option:

< Ask for number of weighings to be deleted>.

Procedure:

- Enter submenu: „ **Reports /**  **Reports configuration**” according to ch. 35 of this manual,
- Activate option **< Ask for number of weighings to be deleted>**,
- Upon returning to home screen and pressing programmable button **< Undo weighing>**, message: **<Number of weighings to be deleted>** with a numeric keyboard is displayed,
- Enter appropriate value (from 1 to 10) and press  button for confirmation, message: **<Number of deleted weighings: x>** is displayed, where **x** – number of deleted weighings.

Caution:



When:

- Some of the weighings that are to be deleted refer to any kind of report (report on dosing, report on formula, report on PGC control, report on vehicle scale, report on density, report on differential weighing) then the following message is displayed **<Number of deleted weighings: x. Remaining weighings are report-related>**.
- All of the weighings that are to be deleted refer to any kind of report (report on dosing, report on formula, report on PGC control, report on vehicle scale, report on density, report on differential weighing) then the following message is displayed **<Operation not allowed. Weighings are report-related>**.

35.2. Deleting older data



A user after Logging on as **administrator** can delete older position in the database of weighings  **<Weighing / Alibi>**.

Procedure:

- Enter the submenu  **<Reports>** according to ch. 35 of this manual,
- Enter  **<Delete older data>**, then an editing field is displayed **<Give year>** with the screen keyboard,
- Give a date before which data need to be removed and confirm it by pressing ,





Caution:

*If a user enters a date from the protected period the program displays a message box: **<Wrong value>**.*

- After entering a date beside protected period the program displays a message box: **<Are you sure you want to delete?>**,
- After it is confirmed by  the program will start removing data and after completing it displays the number of deleted records,
- Press  to leave.

35.3. Weighment date search

Procedure:

- Enter  **Reports**> according to ch. 35 of this manual,
- Enter  **Weighing / Alibi**> ,
- Press  **D**, then an editing field appears **<Specify year>** with the screen keyboard,
- Inscribe: year, month, day, hour, minute of weighing and confirm it by pressing .
- The program will automatically display the list of weighments putting at the top the position with the entered date.

35.4. Reports from weighment records

Submenu  **Reports from weighing records**> allows for:

- preview of data for particular weighments,
- data filtering,
- printout of a weighments report,
- preview and a printout of weighments diagram,
- export of weighments database to file,
- preview and edition of global weighing counter.

Each weighment sent from scales to a printer or to a computer is saved in weighments reports. The user may preview data of a particular weighment (see point 35.5.1 of this manual).



35.4.1. Filtering

The user may filter reports form carried out weighments. The reports will be printed with the use of a printer connected to scales.



Weighments reports may be filtered according to:

- start date,
- end date,
- operator name,
- product name,
- client name,
- packaging name,
- MIN value,
- MAX value,
- lot number,
- batch number,
- source warehouse name,
- target warehouse name,
- result control,
- platform number.

Procedure:

- Enter submenu: „ **Reports** /  **Reports From weighing records** /  **Filtering**” according to ch. 35 of this manual,
- Enter a particular filter position and activate **<Filtering>** option.

Where:

-  - Active filtering
-  - Inactive filtering

35.4.2. Report printout

The user can print a report after executed weighing series. The reports will be printed with the use of a printer connected to scales.

Procedure:

- Enter submenu: „ **Reports** /  **Reports From weighing records**” according to ch. 35 of this manual,

- Entering  **Report printout**> option enables automatic printout of a weighments report. The report can be printed with the use of a printer connected to scale.

Default value of a weighment report template:





```

-----
Report from weighments
-----
{40:Start date:,-20}{101}
{40:End date:,-20}{102}

Weighing records
{100:
  (40:Date:,-10)(4)
  (40:Mass:,-10)(6) (10)
}-----
{40:Number of weighments:,-20}{115}
{40:Totalized weighments:,-20}{116}{11}

```

Caution:

- Submenu: „ **Devices** /  **Printer** /  **Printout** /  **Report From Weighments Printout Template**” allows for free modification of a report template (see point 16.2.3 of this manual);
- If there is too much information printed (too many weighments) the program displays the following message **<Process in progress>**. Percentage (%) notification is added.



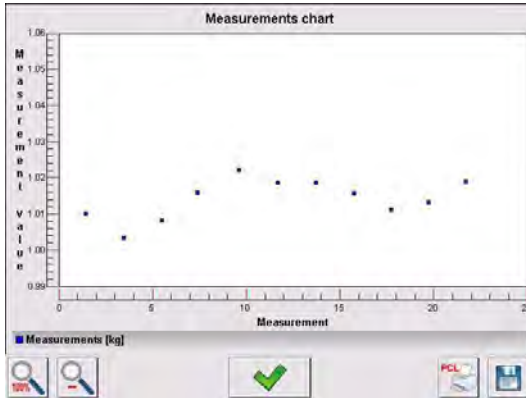

35.4.3. Weighments chart

For an executed weighment series  **Weighments chart**> option generates and displays a diagram of measurements distribution in a **measurement value / measurement** coordinate system.

Example view of a diagram:



Available options, located below the diagram:



	100% zoom of a diagram
	Zoom out, the diagram gets back to its previous size
	Display the previous window
	Print the diagram, use a PCL type printer
	Save the diagram as a *.bmp file, save it to a memory stick connected to USB port

















35.4.4. Export a database to a file









An operator after a series of weighments can export a database to a file using a pen drive. Additionally, a user can select data to be exported.

Procedure:



- Connect a pen drive to USB,
- Enter submenu: “ **Reports** /  **Weighing/Alibi**” according to ch. 35 of this manual,

- Enter submenu: “ **Export database of weighments to a file /**
 **Data selection**”, which contains the following options:

Icon	Option	Default value
	Automatically *	<input type="checkbox"/>
	Date and Time	<input checked="" type="checkbox"/>
	Mass	<input checked="" type="checkbox"/>
	Tare	<input checked="" type="checkbox"/>
00285	Lot number	<input checked="" type="checkbox"/>
12ABC	Batch number	<input checked="" type="checkbox"/>
	Operator	<input checked="" type="checkbox"/>
	Product	<input checked="" type="checkbox"/>
	Client	<input checked="" type="checkbox"/>
	Package	<input checked="" type="checkbox"/>
	Source warehouse	<input checked="" type="checkbox"/>
	Target warehouse	<input checked="" type="checkbox"/>
	Checkweighing	<input checked="" type="checkbox"/>
	Platform number	<input checked="" type="checkbox"/>
	Statistics: Number of measurements	<input checked="" type="checkbox"/>
	Weighing counter	<input checked="" type="checkbox"/>
	Trade settlement	<input checked="" type="checkbox"/>
	Vehicle	<input checked="" type="checkbox"/>
	Universal variable	<input checked="" type="checkbox"/>
	Extra variable	<input checked="" type="checkbox"/>

	Custom variable: Value	
	Custom variable: Name	
	Min	
	Max	

*) – Automatic selection of data to be exported (unfilled fields are omitted)

- After declaring data to be exported go back to the submenu
 **<Export database of weighments to a file>** and select option
 **<Export>**. The software automatically initiates exporting of the database of weighments.

Caution:

*In case a pen drive is not recognized after entering  **<Export database of weighments to a file>** a message is displayed: **<Operation failed>**.*

- After the operation has been completed: „**Operation finished successfully**” is displayed together with the file name (with extention *.txt) created on the pendrive,



Caution:

*The file name consists of a database name and scale factory number, e.g. **<Weighments_239800.txt>**.*

- Disconnect the pendrive to USB.

File template:

The created file comprises a table with columns separated by tabulation characters **<Tab>** in case to allow direct export to a spreadsheet **<Excel>**. The table features all data on a completed weighment record declared in

the submenu: „ **<Export database of weighments to a file /  **Data selection****”.



35.4.5. Counter of weighments records

The counter of weighments records contains global number of completed weighments records carried out on the scale. The user can edit the counter of weighments records.

Caution:

Access to the editing of the  **<Weighing counter>** is conditioned by the accessibility settings for this parameter.



Editing procedure:

- Enter submenu  **<Reports>** in accordance with point 35 of the user manual,
- Enter option  **<Weighing counter>** which opens an editing window with the value of the counter of weighing records and an on-screen numeric keyboard.
- Insert desired value and accept it by pressing  key.





35.5. Reports preview











35.5.1. Weighments / Alibi

Procedure:

- Enter  **<Reports>** according to ch. 35 of this manual,
- Enter  **<Weighments / Alibi>** and press the required position.







Weighment record:

	Date	Weighment date
	Mass	Weighment result
	Tare	Tare value
	Product	Product name
	Operator	Operator name

	Client	Client name
	Lot number	Number of produced lot
	Batch number	Number of produced batch
	Source warehouse	Source warehouse name
	Target warehouse	Target warehouse name
	Package	Package name
	Checkweighing	A weight threshold (MIN, OK or MAX)
	Platform number	Platform number to perform weighments
	Statistics: Number of measurements	Statistics: Current number of measurements
	Weighing counter	Global counter of weighment records



<  **Trade settlement** > submenu will be created automatically in a weighment record when a chosen product is being weighed.

List of <  **Trade settlement** > submenu data:







	Mass	Weighment mass
	Mass of the unit	Unit mass of the product
	Price	Unit price of the product
	VAT	Percent Vat value of the product [%]
	Discount	Percent discount for the client [%]
	Value	Net charge
	Gross	Gross charge

35.5.2. Reports from dosing

Procedure:



- Enter < **Reports**> according to ch. 35 of this manual,
- Enter < **Reports from dosing**> and press the required position.

List of data for a selected report from dosing:



	Status	Status of correctness for a completed dosing process
	Start date	Start date of dosing process
	End date	End date of dosing process
	Dosing process	Name of completed dosing process
	Operator	Operator preparing a dosing process
	Client	Client for which the dosing process is prepared
	Number of Measurements	Number of measurements within a completed dosing process





35.5.3. Reports from recipes

Procedure:

- Enter < **Reports**> according to ch. 35 of this manual,
- Enter < **Report from formulation**> and press the required position.



List of data for a specific report from a formulation:

	Status	Status of correctness for a completed formulation
	Start date	Start date of formula making process











	End date	End date of formula making process
	Formulation	Name of completed formulation
	Operator	Operator preparing a formulation
	Client	Client for which the formulation is prepared
	Number of Measurements	Number of measurements within a completed formulation making process







35.5.4. Density reports

Procedure:

- Enter < **Reports**> according to ch. 35 of this manual,
- Enter < **Density Reports**> and press the required position.

List of data for a specific report from density determination process:

	Sample number	Number of sample for which the density is determined
	Start date	Start date of density determination process
	End date	End date of density determination process
	Density	Value of determined density
	Volume	Value of determined volume
	Determination method	Method used in process of determining density
	Operator	Operator carrying out density determination process
	Product	Product for which density is determined
	Standard liquid	Standard liquid utilized during density determination process
	Standard liquid density	Density value assigned to the standard liquid

	Temperature	Temperature of the density determination process
	Sinker volume	Value of sinker's volume immersed in tested liquid
	Weighing 1	Mass value of the 1 measurement
	Weighing 2	Mass value of the 2 measurement
	Weighing 3	Mass value of the 3 measurement
	Pycnometer mass	Value of pycnometer's mass utilized during density determination process
	Pycnometer density	Value of pycnometer's volume utilized during density determination process

35.5.5. Controls reports

Every control procedure performed on the scale is sent to a printer and saved in database < **Controls Reports**>. Every saved control has its unique number given at the moment it is completed.

Control number pattern:

X / y y / M M / d d / H H / m m / s s, where:

X - Control mode:

- U – regulation compliant control,
- W – Internal control
- Z – control terminated by an operator,

yy – the last two digits of year,

MM - month,

dd - day,

HH - hour,

mm - minute of control completion,











ss - second of control completion.

Users can view data from subsequent controls.

Procedure:

- Enter submenu < **Reports**> according to ch. 35 of this manual,
- Enter database < **Controls Reports**> and choose a required one.

Inventory of fields in every control:

	Batch number	Batch number of tested goods
	Status	Control Status/Result
	Start Date	Control beginning date
	End Date	Control finishing date
	Product	Tested product name
	Operator	Operator performing the test
	X	Average value of weighments
	DX	Disqualifying average value
	S	Standard deviation
	Batch quantity	Number of products in a batch for which a sample quantity is calculated
	Sample quantity	Number of weighments to be performed

35.5.6. Average tare reports

Before starting control <**Nondestructive Average Tare**> it is possible to perform the procedure of estimating average tare that consist in weighing empty packages. Every such procedure is automatically saved in database < **Average Tare Reports**>. Every report saved in the database is given a unique number after the procedure has been completed.

Report number pattern:

X / y y / M M / d d / H H / m m / s s / T, where:

X - Test mode:

U – regulation compliant test,

Z – test terminated by an operator,

yy – the last two digits of year,

MM - month,

dd - day,

HH - hour,

mm - minute of test completion,

ss - second of test completion,









T – average tare estimation.

Users can view data from subsequent average tare tests.

Procedure:



- Enter submenu  **Reports** according to ch. 35 of this manual,
- Enter database  **Average Tare Reports** and choose a required one.

Inventory of fields in the average tare database:











	Product	Product name which packages are tested
	Status	Test Status/Result
	Date	Date of performing procedure
	Tare	The result
	S	Standard deviation
	0.25 T1	Condition to fulfill
	Number of measurements	Number of measurements of subsequent packages
	Operator	An operator name

35.5.7. Report from vehicle scale

Procedure:

- Enter submenu < **Reports**> according to ch. 35 of this manual,
- Enter database < **Vehicle Scale Reports**> and choose a required one.

List of data for an individual report from vehicle scale:

	Vehicle	Vehicle registration number
	Status	Transaction status. Accessible values: Loading, Unloading
	Transaction type	Type of carried out transaction. Accessible values: Entrance, Exit, Control weighment
	Start date	Transaction start date
	End date	Transaction end date
	Load mass	Mass of load on weighed vehicle
	Mass on entrance	Mass of weighed vehicle on entrance
	Mass on exit	Mass of weighed vehicle on exit
	Operator	Operator carrying out a transaction process
	Client	Client assigned to a transaction
	Product	Product assigned to a transaction











35.5.8. Differential weighments reports

Procedure:

- Enter submenu < **Reports**> according to ch. 35 of this manual,

- Go to submenu  **Differential weighments reports**> and press appropriate position.

List of data definable for differential weighments report:

		Start date	Start date of the differential weighing process
		End date	End date of the differential weighing process
		Weighing 1 *	List of data for an executed weighing 1
		Weighing 2 *	List of data for an executed weighing 2
		Difference	Difference (absolute value) between weighing 1 and weighing 2. In case of processes consisting of more than two weighments this value is inaccessible.
		Statistics	Statistical data of a differential weighing process. Submenu is available in case of a process consisting of more than two weighments.
		Weighing: Min	Minimal weighing value, the lowest value out of the whole series of measurement
		Weighing: Max	Maximal weighing value, the highest value out of the whole series of measurement
		Average	Average value out of the whole series of measurement
		Standard deviation	Average standard deviation out of the whole series of measurement

*) – in case of process consisting of more than two weighments the data will be grouped in a folder **<Weighing records>**.

36. IDENTIFICATION PROCESSES

The user can create his own scales operation algorithm and at the same time adjust the device to his needs (production department specific, production line, etc...).

This allows the user to register detailed weighment report with unique data being stored during the process. Through this it is possible to identify and localize faulty products (lot of products) of chain manufacturing processes.

Identification processes can be carried out in the following working modes:

- weighment,
- items counting,
- deviations.

Identification processes can be activated by:

- programmable button,
- operator logging,
- product selection.







36.1. Identification process – creation

Identification processes are designed in  **Identification processes**> database.

Caution:

Process identification database mechanisms of edition and record finding are similar to other databases mechanisms.

Procedure:

- Enter submenu: „ **Databases** /  **Identification processes**”,
- Press , to see **<Create new record?>** message,
- Press  to confirm, the program will automatically edit the new position.
- Fill in the required fields and go to  **Process design**> submenu,
- To set the process operation algorithm press  **Add** and choose one of the available functions of the process (see point 36.2 to view the chart). Each of the functions is added one by one.









Caution:























It is possible to modify an already existing process. To add an element to the existing process press and hold for about 2 seconds the element before which the function is to be added. The following menu will be shown:









Edit
Add
Delete
Cancel

36.2. List of identification process functions

When designing the identification process the user can use the following functions (steps of a process):

Icon		Function	Description
		Select item from database	Function enabling to select the database demanded record
		Databases	Database declaration procedure that allows to choose a record: product, operator, client, packaging, source warehouse, target warehouse, extra variable
		Selection mode	Position declaration procedure according to which the search is to be done. Possible positions: standard, name, code. In case of „extra variables“ function is not available.
		Assign to extra variable	Assignment of a extra variable chosen during the process to a particular extra variable of the weighment database reports. Possible values range from 1 to 5. Function available only in case of “extra variables” database.
		Initial position	Declaration of initial position of database chart. It is displayed during the process of record searching.
		Final position	Declaration of final position of database chart. It is displayed during the process of record searching. Setting 0 value results in display of the whole database chart.
		Set position taken form database	Function sets a demanded record taken from a particular database.
		Databases	Declaration of a database for setting a record: product, client, packaging, source warehouse, target warehouse, lot number, batch number, extra variable, universal variable

	Product	Selection of a demanded position out of product chart (default database). This function is dependent form declared database.
	Do a series of weighments	Function inducing execution of a particular weighments series.
	Mode	Weighments series mode Number – execution of a particular number of weighments Mass – weighing-out a determined mass. None – no limit for number of weighings and no weight limit
	Threshold	Declaration of either weighing number or mass value, depending on the weighments series mode
	Set MIN and MAX	Function setting MIN, MAX thresholds of checkweighing
	Zero	Function of platform zeroing, identical like →0← button of the terminal
	Tare	Function of platform tarring, identical like →T← button of the terminal
	Edit lot number	Function editing a lot number
	Edit batch number	Function editing a batch number
	Information window	Function inducing freely designed information window
	Name	Information window name, located at the top bar of the window
	Description	Information window description
	Image	Information window image. Possible choices: <  information>, <  Warning>, <  Error>.
	Button	Declaration of buttons for an information window. Possible choices: „Ok” or „Ok Cancel”
	Add custom variable	Function inducing a new custom variable. This variable is automatically saved in a report (weighments database) upon the end of a process.
	Type of variable	Declaration of custom variable type. Possible choices: text variable, numeric variable.
	Name	Custom variable name.
	Assign to custom variable	Assigning of a custom variable to a proper custom variable of the weighing database reports. Possible values range from 1 to 255.
	Edit product	Function inducing change (edition) of variables for a given product. It is omitted if during previous steps of the process the product has not been chosen.

	Type of variable	Declaration of type of product variable, which is to be edited: mass, price, number of days left before the expiry date, additional days of expiry period
	Outputs	Function setting terminal outputs state, for control of peripherals. Possible values: None: - inactive output; „0” – low output state; „1” – high output state.
	Delay	Function setting intervals between steps of a dosing process. Function defines amount of time interval until the next step of a process, given in [s].
	Input condition	Conditional function, determines when the next step of a process is to be executed, it depends on an input state of a terminal. Possible values: None – inactive input; „0” - low input state; „1” – high input state; „r” – rising edge on input (change from low state to high state, eg.: the moment of pressing a button); „f” – trailing edge (change from high state to low state, eg.: the moment of releasing a button)
	Edit universal variable	Function activating edition of universal variable
	Assign to universal variable	Assigning a universal variable to an appropriate universal variable in reports (database). Values: from 1 to 3.
	Button functions	Activating determined button function.
	Operation	Selecting button function.

36.3. Identification process – activation procedure

Identification processes may be activated by:



- Programmable button,
- Operator logging,
- Product selection.

36.3.1. Activation by programmable button

Submenu  **Button functions**> allows for free configuration of programmable buttons (see point 17.2 of this manual).

Procedure:

- For a chosen button set one of three functions:



	Select an identification process
	Select an identification process by name
	Select an identification process by code

- Go back to the main window,
- Press programmable button and select an appropriate identification process to activate it.

36.3.2. Activation by operator logging

User may assign an identification process to an operator. It results in automatic start of a process right after the logging procedure has been carried out.

Procedure:

- Enter submenu: „ **Databases /**  **Operators**” and select an appropriate position,
- Go to <  **Identification process** > field and select a demanded process, than go back to the main window.
- Log in as an earlier edited operator, and wait for an automatic activation of an identification process assigned to this operator to proceed.

36.3.3. Activation by product selection

User may assign an identification process to a product. It results in automatic start of a process right after a product has been selected out of a database.

Procedure:

- Enter submenu: „ **Databases /**  **Products**” and select an appropriate position,
- Go to <  **Identification process** > field and select a demanded process, than go back to the main window,

- Out of a database select an earlier edited product, and wait for an automatic activation of an identification process assigned to this operator to proceed.



36.3.4. Example of process forming and its realization

Description:

User must get through the following balance operation algorithm:

1. Carry out the operator logging process with the use of a transponder card,
2. Give a shift number,
3. Zero scales,
4. Information window „Prepare a product to be weighed” (message 60[s]),
5. Select a product by EAN code, use a barcode scanner,
6. Give a present price of a product,
7. Out of a list select „Country of origin”,
8. Select client code,
9. Out of a list select „Supplier country”,
10. Give a lot number,
11. Give a batch number,
12. Information window „Start a weighing process”.

Identification process forming:

- Create a new record  **Identification process** according to point 36.1. of this manual,
- Go to submenu  **Process creator** to create further steps of the process:

Step	Function	Description
1. Add custom variable	Variable type: numeric variable; Name: shift number; assign to custom variable 1	Displays „Shift number” dialog window for edition with a numeric keyboard
2. Zero	Zero	Automatic zeroing
3. Delay	Time: 60s; Description: Prepare a product to be weighed	Displays window „Prepare product to be weighed” for 60 seconds
4. Select item from database	Database: Product; selection mode: Standard; start position: 1; end position: 0	Displays list of products. Configuration and selection of data with the use of barcode scanner is described in point 16.3 of this manual.

5. Edit product	Variable type: Price	Displays window: „Record edition: product / price” with a numeric keyboard
6. Select item from database	Database: extra variable; assign to extra variable: 2; start position: 1; end position: 20	Displays chart of extra variable from position 1 to 20. Naming chart: “Country of origin” – see point 34.1.4 of this manual
7. Select item from database	Database: Client; selection mode: Code; start position: 1; end position: 0	Displays window: „Search by code”.
8. Select item from database	Database: extra variable; Assign extra variable: 3; start position: 21; end position: 40	Displays chart of extra variables from position 21 to 40. Naming chart: “Supplier country” – see point 34.1.4 of this manual
9. Edit lot number	Edit lot number	Displaying „Lot number” dialog window with numeric keyboard
10. Edit batch number	Edit batch number	Displaying „Batch number” dialog window with numeric keyboard
11. Information window	Name: Information; Description: start weighing; Image: Information; Button: OK	Displaying „Start weighing process” information window

- Assign transponder card number to an appropriate operator, to do it follow point 16.4.2 of this manual,
- Assign a created identification process to an appropriate operator to do it follow point 36.3.2 of this manual,
- Log in with the use of a transponder card to automatically activate identification process assigned to the given operator,
- After weighing all unique data edited during weighing process will be saved to reports from weighing:
 - Mass,
 - Shift number,
 - Product name,
 - Product price,
 - Country of origin,
 - Client name,
 - Supplier country,
 - Lot number,
 - Batch number.

User may break the identification process or get back to its previous step.

In order to break identification process one must:

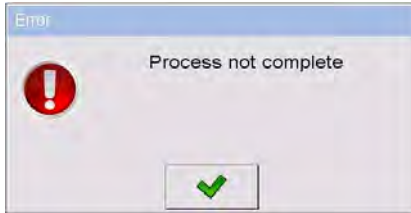

- Press  button of the main window of a process to see a message:



Press  button to confirm and wait for the following window:





Press  **Abort**> button.

- Press  button of an edit window or information window, press  button of database data chart to see the following window:



Press  **Abort**> button.

In order to get back to a previous step of a process one must:

- Press  button of an edit window or information window, press  button of database data chart to see the following window:





- Press  **List of steps** button to see the list of carried out steps,
- Select a given position (step) out of the list and wait, the program will automatically get back to a chosen step.

37. COMMUNICATION PROTOCOL

37.1. General information

- A. Scales-terminal serial communication protocol serves for communication between RADWAG scales and peripheral device, it uses RS-232C and Ethernet interface;
- B. It consists of commands sent from an external device to the scale and a responses from a scale.
- C. Responses are sent every time after receiving a command (reaction for any command).
- D. Using commands allows users to receive some information about the state of scale and/or influence the operation e.g.: Requesting weighing results, display control.

Caution:

Go to submenu: „ **Devices** /  **Computer** /  **Port**” to declare communication port (see point 16.1.1 of this manual).

37.2. List of RS commands

Commands	Description of commands
Z	Zeroing
T	Tarring
OT	Get tare value
UT	Set tare value
S	Send the stable result in basic unit
SI	Send the result immediately in basic unit
SIA	Send immediate results from all platforms in basic units
SU	Send the stable result in current unit
SUI	Send the result immediately in current unit
C1	Switch on continuous transmission in basic unit
C0	Switch off continuous transmission in basic unit
CU1	Switch on continuous transmission in current unit
CU0	Switch off continuous transmission in current unit
DH	Set lower threshold
UH	Set upper threshold
ODH	Read lower threshold
OUH	Read upper threshold
SS	Simulation of pressing ENTER/PRINT key
P	Change platform
NB	Give balance serial number
SM	Set mass value of a single item
RM	Set reference mass value
BP	Activate sound signal
OMI	Give available working modes
OMS	Set working mode
OMG	Give current working mode
PC	Send all implemented commands

Caution:

1. Each command have to be terminated in CR LF;
2. The best Policy for communication is not sending another command until the former answer has been received.

37.3. Respond message format

After sending a request message you can receive:

XX_A CR LF	command accepted and in progress
XX_D CR LF	command completed (appears only after XX_A)
XX_I CR LF	command comprehended but cannot be executed
XX_^ CR LF	command comprehended but time overflow error appeared
XX_v CR LF	command comprehended but the indication below the
XX_OK CR LF	Command done
ES CR LF	Command not comprehended
XX_E CR LF	error while executing command – time limit for stable result exceeded (limit time is a descriptive parameter of the scale)

XX - command name
_ - substitutes spaces

37.4. Command's description

37.4.1. Zeroing

Syntax **Z CR LF**

Possible answers:

Z_A CR LF - command accepted and in progress
Z_D CR LF - command completed
Z_A CR LF - command accepted and in progress
Z_^ CR LF - command comprehended but zero range overflow appeared
Z_A CR LF - command accepted and in progress
Z_E CR LF - time limit for stable result exceeded
Z_I CR LF - command comprehended but cannot be executed

37.4.2. Tarring

Syntax: **T CR LF**

Possible answers:

- T_A CR LF** - command accepted and in progress
- T_D CR LF** - command completed
- T_A CR LF** - command accepted and in progress
- T_v CR LF** - command comprehended but tare range overflow appeared
- T_A CR LF** - command accepted and in progress
- T_E CR LF** - time limit for stable result exceeded
- T_I CR LF** - command comprehended but cannot be executed

37.4.3. Get tare value

Syntax: **OT CR LF**

Reply: **OT_TARA CR LF** – command executed

Frame format:

1	2	3	4-12	13	14	15	16	17	18	19
O	T	space	tare	space	unit		space	CR	LF	

- Tare** - 9 characters justified to the right
- Unit** - 3 characters justified to the left

Caution:

Tare values are always send in adjustment unit.

37.4.4. Set tare value

Syntax: **UT_TARE CR LF**, where **TARE** – tare value

Possible replies:

- UT_OK CR LF** - command completed
- UT_I CR LF** - command correct, but not accessible at the moment
- ES CR LF** - command incorrect (e.g. incorrect tare format)

Caution:

Use dots as decimal points in tare values.

37.4.5. Send the stable result in basic unit

Syntax: **S CR LF**

Possible answers:

- S_A CR LF** - command accepted and in progress
- S_E CR LF** - time limit for stable result exceeded
- S_I CR LF** - command comprehended but cannot be executed
- S_A CR LF** - command accepted and in progress
- MASS FRAME** - mass value in basic unit is returned

Frame format:

1	2-3	4	5	6	7-15	16	17	18	19	20	21
S	space	stability	space	sign	mass	space	unit			CR	LF

Example:

S CR LF – computer command

S_A CR LF - command accepted and in progress

S _ _ _ _ - _ _ _ _ _ 8 . 5 _ g _ _ CR LF – command done, mass value in basic unit is returned.

37.4.6. Send the result immediately in basic unit

Syntax: **SI CR LF**

Possible answers:

- SI_I CR LF** - command comprehended but cannot be executed at the moment
- MASS FRAME** - mass value in basic unit is returned

Frame format:

1	2	3	4	5	6	7-15	16	17	18	19	20	21
S	I	space	stability	space	sign	mass	space	unit			CR	LF

Example:

S I CR LF – computer command

S I _ ? _ _ _ _ _ 1 8 . 5 _ k g _ CR LF - command done, mass value in basic unit is returned immediately.

37.4.7. Send immediate results from all platforms in basic units

Syntax: **SIA CR LF**

Possible answers:

SIA_I CR LF - command comprehended but cannot be executed at the moment

MASS FRAME „P1” CR LF

MASS FRAME „P2” CR LF - mass values are immediately returned from all platforms in basic units

Frame format with mass from subsequent platforms as indicator reply:

1	2	3	4	5	6	7-15	16	17	18	19	20	21
P	n	space	stability	space	sign	mass	space	unit			CR	LF

n - weighing platform number

mass - 9 characters justified to the right

unit - 3 characters justified to the left

Example:

Let us assume that both platforms are connected to scale.

S I A CR LF – computer command

P 1 _ ? _ _ _ _ _ 1 1 8 . 5 _ g _ _ CR LF

P 2 _ _ _ _ _ 3 6 . 2 _ k g _ CR LF - command done, mass values from both platforms are returned in basic units

37.4.8. Send the stable result in current unit

Syntax: **SU CR LF**

Possible answers:

- SU_A CR LF** - command accepted and in progress
- SU_E CR LF** - timeout while waiting for stable results
- SU_I CR LF** - command comprehended but cannot be executed
- SU_A CR LF** - command accepted and in progress
- MASS FRAME** - mass value in current unit is returned

Frame format:

1	2	3	4	5	6	7-15	16	17	18	19	20	21
S	U	space	stability	space	sign	mass	space	unit			CR	LF

Example:

- S U CR LF** – computer command
- S U _ A CR LF** - command accepted and in progress
- S U _ _ _ - _ _ 1 7 2 . 1 3 5 _ N _ _ CR LF** - command done, mass value in current unit is returned.

37.4.9. Send the result immediately in current unit

Syntax: **SUI CR LF**

Possible answers:

- SUI CR LF** - command comprehended but cannot be executed
- MASS FRAME** - mass value in current unit is returned immediately

Frame format:

1	2	3	4	5	6	7-15	16	17	18	19	20	21
S	U	I	stability	space	sign	mass	space	unit			CR	LF

Example:

- S U I CR LF** – computer command
- S U I ? _ - _ _ _ 5 8 . 2 3 7 _ k g _ CR LF** - command executed and mass returned

37.4.10. Switch on continuous transmission in basic unit

Syntax: **C1 CR LF**

Possible answers:

C1_I CR LF - command comprehended but cannot be executed

C1_A CR LF - command comprehended and in progress

MASS FRAME - mass value in basic unit is returned

Frame format:

1	2	3	4	5	6	7-15	16	17	18	19	20	21
S	I	space	stability	space	sign	mass	space	unit			CR	LF

37.4.11. Switch off continuous transmission in basic unit

Syntax: **C0 CR LF**

Possible answers:

C0_I CR LF - command comprehended but cannot be executed

C0_A CR LF - command comprehended and executed

37.4.12. Switch on continuous transmission in current unit

Syntax: **CU1 CR LF**

Possible answers:

CU1_I CR LF - command comprehended but cannot be executed

CU1_A CR LF - command comprehended and in progress

MASS FRAME - mass value in current unit is returned

Frame format:

1	2	3	4	5	6	7-15	16	17	18	19	20	21
S	U	I	stability	space	sign	mass	space	unit			CR	LF

37.4.13. Switch off continuous transmission in current unit

Syntax: **CU0 CR LF**

Possible answers:

CU0_I CR LF - command comprehended but cannot be executed

CU0_A CR LF - command comprehended and executed

37.4.14. Set lower threshold

Syntax: **DH_XXXXX CR LF**, where: **XXXXX** – mass format

Possible answers:

DH_OK CR LF - command executed

ES CR LF - command not comprehended (wrong mass format)

37.4.15. Set upper threshold

Syntax: **UH_XXXXX CR LF**, where: **XXXXX** – mass format

Possible answers:

UH_OK CR LF - command executed

ES CR LF - command not comprehended (wrong mass format)

37.4.16. Read lower threshold

Syntax: **ODH CR LF**

Possible answers: **DH_MASA CR LF** - command executed

Frame format:

1	2	3	4-12	13	14	15	16	17	18	19
D	H	space	mass	space	unit			space	CR	LF

Mass - 9 characters justified to the right

Unit - 3 characters justified to the left

37.4.17. Read upper threshold

Syntax: **OUH CR LF**

Possible answers: **UH_MASA CR LF** - command executed

Frame format:

1	2	3	4-12	13	14	15	16	17	18	19
U	H	space	mass	space	unit			space	CR	LF

Mass - 9 characters justified to the right

Unit - 3 characters justified to the left

37.4.18. Simulation of pressing ENTER/PRINT key

Syntax: **SS CR LF**

Sending a command **S S CR LF** to a scale causes automatic saving of a weighing record in the database and simultaneous activating a declared printout template.

Caution:

While sending the command to a scale, all criteria for successful measurement execution have to be met, i.e. result control, stable mass indication, etc.

37.4.19. Change platform

Syntax: **PN CR LF**, where **N** – number of platforms (1 to 4)

Possible answers:

PN_OK CR LF - command completed

PN_I CR LF - command correct, but not accessible at the moment

ES CR LF - command incorrect (e.g. incorrect number of platforms)

37.4.20. Give balance serial number

Syntax: **NB CR LF**

Possible answers:

NB_A_”x” CR LF - command understood, returns serial number

NB_I CR LF - command understood but not accessible at this moment

x – serial number of the device (inserted in between inverted commas)

Example:

NB CR LF – give serial number

NB_A_”123456” CR LF – serial number of the device – 123456

37.4.21. Set mass value of a single item

Syntax: **SM_XXXXX CR LF**, where: _ - space, XXXXX – mass format

Possible answers:

SM_OK CR LF - command understood

SM_I CR LF - command understood but not accessible at this moment
(e.g. mode other than „Parts counting”)

ES CR LF - command not recognised (mass format incorrect)

Notice:

*Command supported for „**Parts counting**” mode exclusively.*

37.4.22. Set reference mass value

Syntax: **RM_XXXXX CR LF**, where: _ - space, XXXXX – mass format

Possible answers:

RM_OK CR LF - command understood

RM_I CR LF - command understood but not accessible at this moment
(e.g. mode other than „Deviations”)

ES CR LF - command not recognised (mass format incorrect)

Notice:

*Command supported for „**Deviations**” mode exclusively.*

37.4.23. Activate sound signal

Syntax: **BP_TIME CR LF**

Where: _ - space, **TIME** – parameter, decimal specifying how long shall the sound last, parameter given in [ms]. Recommended range <50 - 5000>.

Possible answers:

- BP_OK CR LF** - command carried out, BEEP sound signal activated
- BP_I CR LF** - command understood but not accessible at this moment
- ES CR LF** - no parameter or incorrect format

Example:

BP_350 CR LF - activate BEEP for 350 [ms]

BP_OKCR LF - BEEP activated

Notice:

1. *If value greater than the permissible high limit is given, than BEEP sound is operated for the maximum permissible amount of time.*
2. *BEEP sound activated via BP command is inhibited if in-course of its activation the sound is activated by means of other device: keypad, touch panel, proximity sensors.*

37.4.24. Give available working modes

Syntax: **OMI CR LF**

Possible answers:

OMI CR LF

n_Mode name CR LF

OK CR LF - command carried out, accessible working modes returned

OMI_I CR LF - command understood but not accessible at this moment

Mode name – parameter, working mode name, inserted in between inverted comas. The name takes form given on a particular balance display, it is provided in a currently selected language.

n – parameter, decimal value determining working mode number

Working modes list:

- 1 – Weighing
- 2 – Parts Counting
- 3 – Deviations
- 4 – Dosing
- 5 – Recipes
- 6 – Weighing Animals
- 7 – Density
- 17 - Control of packaged goods PGC
- 20 - Comparator
- 21 – Vehicle scale

Notice:

Working modes numbering is identical for each kind of balance. The numbers are assigned to working modes names. Some balances give only the number as a response.

Example:

- OMI CR LF** - give accessible working modes
- OMI CR LF** - accessible working modes are given
- 2_”Parts Counting” CR LF** - number + name
- 4_”Dosing” CR LF**
- 5_”Recipes” CR LF**
- OK CR LF** - command carried out

37.4.25. Set working mode

Syntax: **OMS_n CR LF**

Where: n – parameter, decimal value determining working mode number.
To see detailed description go to OMI command.

Possible answers:

- OMS_OK CR LF** - command carried out
- OMS_I CR LF** - command understood but not accessible at this moment
- OMS_E CR LF** - error in-course of command execution, no parameter or incorrect format

Example:

OMS_2 CR LF - set working mode "Parts counting"
OMS_OK CR LF - working mode "Parts counting"

37.4.26. Give current working mode

Syntax: **OMG CR LF**

Possible answers:

OMG_n Mode name CR LF - command carried out, current working mode given
OMG_I CR LF - command understood but not accessible at this moment

Mode name – working mode name, presented in a form that is displayed for a particular device type, written in a currently selected language.

n – parameter, decimal value determining working mode number.
To see detailed description go to **OMI** command.

Example:

OMG CR LF- give current working mode
OMG_2 Parts counting CR LF – balance operates in working mode "Parts counting"

37.4.27. Send all implemented commands

Syntax: **PC CR LF**

Possible answers:

PC_A "Z,T,S,SI,SU,SUI,C1,C0,CU1,CU0,DH,ODH,UH,OUH,OT,UT,SIA,SS,PC,P1,P2,P3,P4,NB,SM,RM,BP,OMI,OMS,OMG" – command executed, the indicator have sent all the implemented commands.

37.5. Manual printouts / automatic printouts

Users can general manual or automatic printouts from the scale.

- Manual printouts can be performed after loading the pan and stabilizing indication by pressing .
- Automatic printouts can be performed only after loading the pan and stabilizing indication.

Format frame:

1	2	3	4 -12	13	14	15	16	17	18
stability	space	sign	mass	space	unit			CR	LF

- Stability character** [space] if stable
 [?] if not stable
 [^] if an indication over the range
 [v] if fan indication below the range
- sign** [space] for positive values or
 [-] for negative values
- mass** 9 characters justified to the right
- unit** 3 characters justified to the left
- command** 3 characters justified to the left

Example:

_____ 1 8 3 2 . 0 _ g _ _ CR LF – the printout generated from the scale after pressing .

38. MODBUS RTU COMMUNICATION PROTOCOL

The terminal PUE 7.1 enables complete operation of programmable controllers (PLC), which communicate through Modbus protocol class 0. The terminal in a network using modbus standard operates as slave on an accessible interfaces, **RS232** or **Ethernet**. According to the standard, Modbus class 0, the device uses two functions:

- Read multiple registers (fc 3), for cyclic readout of signals from the weighing module,

- Write multiple registers (fc 16), for cyclic record of the weighing module statuses.

The superordinate unit (master):

- Cyclically reads inputs signals from the terminal PUE 7.1,
- Cyclically saves outputs status to the terminal PUE 7.1.

Functions of Modbus communication with the terminal PUE 7.1:

- Mass readout
- Reading current measuring unit
- Reading status
- Tarring
- Zeroing
- Setting and reading **tare** value
- Setting and reading **LO** threshold value
- Setting and reading **Min** threshold value
- Setting and reading **Max** threshold value
- Reading inputs status
- Setting outputs status
- Selecting an operator,
- Selecting a product,
- Selecting a client,
- Selecting a packaging,
- Selecting a source warehouse,
- Selecting a destination warehouse,
- Selecting a formulation,
- Setting the status of dosing process
- Reading the status of dosing process
- Setting LOT number
- Process stopping,
- Process starting,
- Saving / Printing,

38.1. Memory map

38.1.1. Output address

Address Offset	0	1	2	3	4	5	6	7	8	9
0	M 1	M 1	M 1	M 1	T 1	T 1	T 1	T 1	J 1	J 1
1	S 1	S 1	LO 1	LO 1	LO 1	LO1	M 2	M 2	M 2	M 2
2	T 2	T 2	T 2	T 2	J 2	J 2	S 2	S 2	LO 2	LO 2
3	LO 2	LO 2	M 3	M 3	M 3	M 3	T 3	T 3	T 3	T 3
4	J 3	J 3	S 3	S 3	LO 3	LO 3	LO 3	LO 3	M 4	M 4
5	M 4	M 4	T 4	T 4	T 4	T 4	J 4	J 4	S 4	S 4
6	LO 4	LO 4	LO 4	LO 4	ST	ST	SW	SW	MIN	MIN
7	MIN	MIN	MAX	MAX	MAX	MAX	-	-	-	-
8	-	-	-	-	LOT	LOT	LOT	LOT	O	O
9	A	A	K	K	OK	OK	MZ	MZ	MD	MD
10	RC	RC	-	-	-	-	-	-	-	-

Where:

- M** - Mass for a platform, 4 bytes, float
- T** - Tare for a platform, 4 bytes, float
- J** - Current measuring unit of a platform, 2 bytes, word
- S** - Platform status, 2 bytes, word
- LO** - Lo threshold of a platform, 4 bytes, float
- ST** - Process status, 2 bytes, word
- MIN** - MIN threshold, 4 bytes, float
- MAX** - MAX threshold, 4 bytes, float
- LOT** - LOT number, 4 bytes, dword
- O** - Operator, 2 bytes, word
- A** - Product , 2 bytes, word
- K** - Client, 2 bytes word
- OK** - Package, 2 bytes, word
- MZ** - Source warehouse, 2 bytes, word
- MD** - Destination warehouse, 2 bytes, word
- RC** - Formulation, 2 bytes, word
- ST** - Process status, 2 bytes, word
- SW** - Inputs status, 2 bytes, word

38.1.2. Input address

Address Offset	0	1	2	3	4	5	6	7	8	9
0	C	C	CP	CP	P	P	T	T	T	T
1	LO	LO	LO	LO	SW	SW	MIN	MIN	MIN	MIN
2	MAX	MAX	MAX	MAX	-	-	-	-	-	-
3	-	-	LOT	LOT	LOT	LOT	O	O	A	A
4	K	K	OK	OK	MZ	MZ	MD	MD	RC	RC

Where:

- C** - command, 2 bytes, word
- CP** - command with a parameter, 2 bytes, word
- P** - Actual platform , 2 bytes, word
- T** - Tare for a platform, 4 bytes, float
- LO** - Lo threshold of a platform, 4 bytes, float
- SW** - Outputs status, 2 bytes, word
- MIN** - MIN threshold, 4 bytes, float
- MAX** - MAX threshold, 4 bytes, float
- LOT** - LOT number, 4 bytes, word
- O** - Operator, 2 bytes, word
- A** - Product , 2 bytes, word
- K** - Client, 2 bytes, word
- OK** - Package, 2 bytes, word
- MZ** - Source warehouse 2 bytes, word
- MD** - Destination warehouse, 2 bytes, word
- RC** - Formulation, 2 bytes, word

38.2. Description of variables

38.2.1. Output variables

Readout of output variables enables obtaining data on instrument's status.

Notice:

All output values, except for mass, are displayed in adjustment/calibration unit.

List of output variable:

Name of output variable	Address	Length [word]	Data type
Mass platform 1	0	2	float
Tare platform1	4	2	float
Unit platform 1	8	1	word
Status platform 1	10	1	word
Lo platform 1	12	2	float
Mass platform 2	16	2	float
Tare platform 2	20	2	float
Unit platform 2	24	1	word
Status platform 2	26	1	word
Lo platform 2	28	2	float
Mass platform 3	32	2	float
Tare platform 3	36	2	float
Unit platform 3	40	1	word
Status platform 3	42	1	word
Lo platform 3	44	2	float
Mass platform 4	48	2	float
Tare platform 4	52	2	float
Unit platform 4	56	1	word
Status platform 4	58	1	word
Lo platform 4	60	2	float
Process status (Stop, Start)	64	1	word
Input status	66	1	word
Min	68	2	float
Max	72	2	float
LOT number	84	2	word
Operator	88	1	word
Product	90	1	word
Client	92	1	word
Package	94	1	word
Source warehouse	96	1	word
Destination warehouse	98	1	word
Formulation / Dosing	100	1	word

- **mass** – mass value in current unit is returned,
- **tare** – tare value in calibration/adjustment unit is returned,
- **unit** – determines current (displayed) measuring unit:

Unit		Byte no.							Dec
		B5	B4	B3	B2	B1	B0		
g	gram	0	0	0	0	1	0	1	
kg	kilogram	0	0	0	0	0	1	2	
ct	carat	0	0	0	1	0	0	4	
lb	pound	0	0	1	0	0	0	8	
oz	ounce	0	1	0	0	0	0	16	
N	Newton	1	0	0	0	0	0	32	

For instance:

Byte no	B5	B4	B3	B2	B1	B0
Value	0	0	0	0	1	0

Scale use kilogram [kg].

- **status** – determines scale's status

Status bytes	Task	Dec
0	correct measurement (no error message from scale)	1
1	stable measurement	2
2	scale in zero indication	4
3	scale tarred	8
4	scale in second measuring range	16
5	scale in third measuring range	32
6	scale reports NULL error	64
7	scale reports LH error	128
8	scale reports FULL error	256

For instance:

byte no.	B8	B7	B6	B5	B4	B3	B2	B1	B0
value	0	0	0	0	1	0	0	1	1

The scale does not report an error, the measurement is stable in the second measuring range.

- **LO** – the value of **LO** threshold in calibration/adjustment unit is returned.
- **Process status** – determines the status of dosing process

Decimal value of a variable (Dec)	process status	byte no.	
		B1	B0
0	process disabled (inactive)	0	0
1	dosing start	0	1
2	dosing stop	1	0
3	end of dosing process	1	1

- **Inputs status** – determines the status of inputs in a terminal PUE7:

Input no.	12	11	10	9	8	7	6	5	4	3	2	1	Decimal value of a variable (Dec)
OFF	0	0	0	0	0	0	0	0	0	0	0	0	0
ON	1	1	1	1	1	1	1	1	1	1	1	1	4094

- **MIN** – set value of **MIN Threshold** (in calibration/adjustment unit) is returned.
- **MAX** – set value of **MAX Threshold** (in calibration/adjustment unit) is returned.
- **Lot number** – response is the value of lot number (numeric range 0 - 2147483647).
- **Operator** – response is the value of a logged operator (numeric range 0 - 32767).
- **Product** – response is the value of a selected product (numeric range 0 - 32767).
- **Client** – response is the value of a code of a selected client (numeric range 0 - 32767).
- **Packaging** – response is the value of a code of a selected packaging (numeric range 0 - 32767).

- **Source warehouse** – response is the value of a code of a source warehouse (numeric range 0 - 32767).
- **Destination warehouse** – response is the value of a code of a destination warehouse (numeric range 0 - 32767).
- **Formulation** – response is the value of a code of a selected formulation (numeric range 0 - 32767).

38.2.2. Input variables

Saving the input variables into the terminal PUE 7.1 enables controlling module's operation.

Notice:

All input values are set in reaction to calibration/adjustment unit.

Name of input variable	address	length [word]	data type
Command	0	1	word
Complex command	2	1	word
Complex command parameters			
Platform	4	1	word
Tare	6	2	float
LO limit	10	2	float
Output status	14	1	word
Min	16	2	float
Max	20	2	float
Lot number	32	2	word
Operator	36	1	word
Product	38	1	word
Client	40	1	word
Packaging	42	1	word
Source warehouse	44	1	word
Destination warehouse	46	1	word
Formulation / Dossing	48	1	word

- **command** – basic command. Setting of an appropriate command's byte is directly responsible for carrying out a task, in accordance with below table:

command bytes	task	Dec
0	scale zeroing	1
1	scale tarring	2
5	dosing process start	32
6	dosing process stop (emergency stop)	64

For instance:

0000 0000 0010 0000 – command carried out, dosing process start

- **complex command** - Setting of an appropriate command's byte is directly responsible for carrying out a task, in accordance with below table:

command bytes	task	Dec
0	setting tare value	1
1	setting LO threshold value	2
2	setting outputs status	4
3	setting MIN threshold value	8
4	setting MAX threshold value	16

For instance:

0000 0000 0000 0010 – command carried out, LO threshold set to value given in LO parameter (address 10); See Table “Input variables”.

Notice:

A complex command requires setting an appropriate address parameter from 6 to 28. See table “Input variables”.

- **Platform** – complex command parameter: number of a weighing platform.
- **tare** – complex command parameter – tare value (in calibration / adjustment unit).

- **LO** – complex command parameter – **LO** threshold value (in calibration / adjustment unit).
- **outputs status** – complex command parameter determining outputs status of a terminal PUE 7.1 series.

Output status			byte no.			Dec
Out3	Out2	Out1	B2	B1	B0	
OFF	OFF	OFF	0	0	0	0
OFF	OFF	ON	0	0	1	1
OFF	ON	OFF	0	1	0	2
OFF	ON	ON	0	1	1	3
ON	OFF	OFF	1	0	0	4
ON	OFF	ON	1	0	1	5
ON	ON	OFF	1	1	0	6
ON	ON	ON	1	1	1	7

- **MIN** - complex command parameter – **MIN threshold** value (in calibration / adjustment unit).
- **MAX** - complex command parameter – **MAX threshold** value (in calibration / adjustment unit).
- **Lot number** - complex command parameter: the value of lot number (numeric range 0 - 2147483647).
- **Operator** - complex command parameter: the value of a code of a logged operator (numeric range 0 - 32767).
- **Product** - complex command parameter: the value of a code of a selected product (numeric range 0 - 32767).
- **Client** - complex command parameter: the value of a code of a selected client (numeric range 0 - 32767).
- **Packaging** - complex command parameter: the value of a code of a selected packaging (numeric range 0 - 32767).
- **Source warehouse** - complex command parameter: the value of a code of a selected source warehouse (numeric range 0 - 32767).

- **Destination warehouse** - complex command parameter: the value of a code of a selected destination warehouse (numeric range 0 - 32767).
- **Formulation** - complex command parameter: response is the value of a code of a selected formulation (numeric range 0 - 32767).

Notice:

A command or a command with a parameter is carried out once on detecting the setting of a corresponding bit. If it is necessary to repeat a command with the same bit, then first it has to be zeroed.

For instance:

command	address 1	address 0
tarring	0000 0000	0000 0010
zeroing command bytes	0000 0000	0000 0000
tarring	0000 0000	0000 0010

39. COOPERATION WITH PERIPHERAL DEVICES

Scale can cooperate with the following devices:

- Computer,
- Receipt printer,
- Label printer,
- Additional display,
- Barcode scanner,
- Any peripheral device with the compatible ASCII protocol.

40. DIAGRAMS OF CONNECTION CABLES

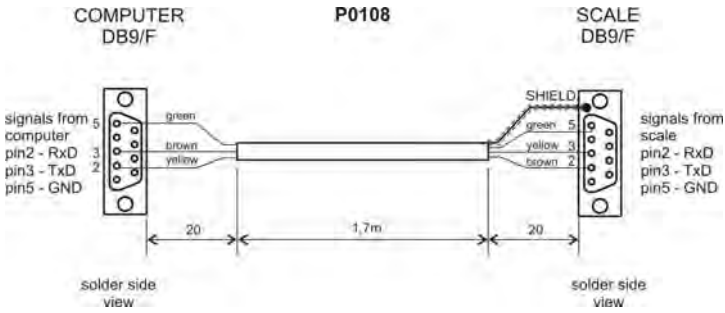

Scale – computer cable

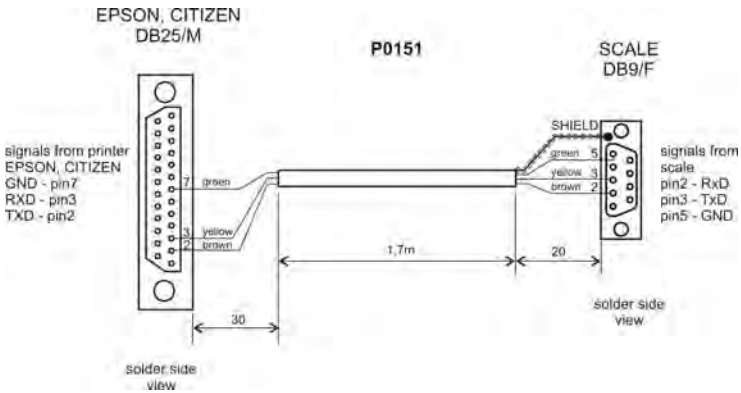

Scale – printer (CITIZEN, EPSON) cable

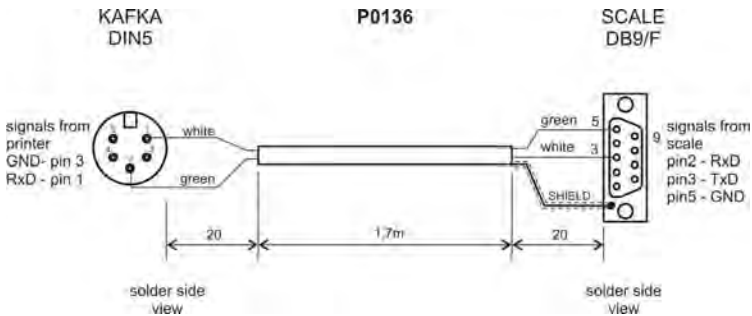

Scale – Kafka printer cable

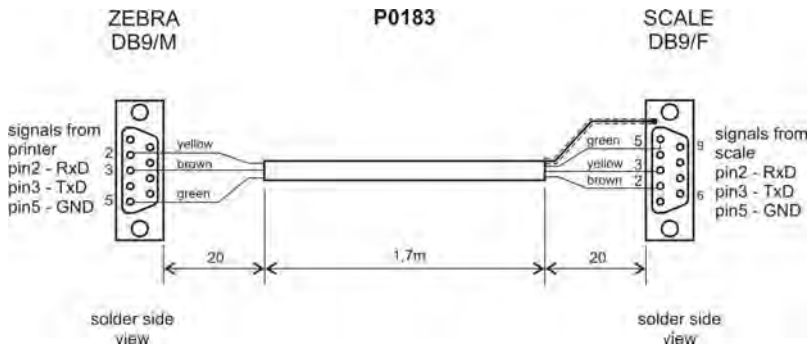

Scale – ZEBRA printer cable

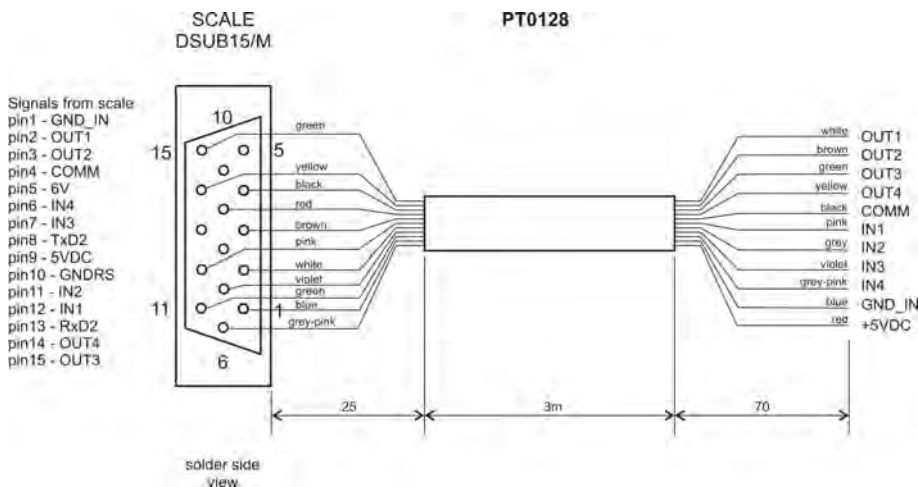

Scale – I/O cable

Caution:

Cable „scale – Ethernet” is a standard network cable with RJ45 connectors on both sides.

41. TECHNICAL PARAMETERS

41.1. Scales of WLY series

Technical data:	WLY 1/D2	WLY 2/D2	WLY 6/D2	WLY 10/D2	WLY 20/D2
		-	-	M	-
Maximum capacity	1kg	2kg	6kg	10kg	20kg
Minimum capacity	-	-	5g	-	-
Reading division [d]	0,01g	0,01g	0,1g	0,1g	0,1g
Verification interval [e]	-	-	1g	-	-
Tare range	-1kg	-2kg	-6kg	-10kg	-20kg
Repeatability	0,03g	0,03g	0,1g	0,3g	0,3g
Linearity	±0,03g	±0,03g	±0,1g	±0,3g	±0,3g
OIML Class	-		II	-	
Stabilization time	3s				
Pan size	195 x 195mm				
Operation temperature	+15°C to +30°C				
Storage temperature	-25°C to +70°C				
Atmospheric humidity	10÷85% RH no condensation				
Ingress protection rating	IP 43				
Power supply	100÷240VAC 50/60Hz – 12VDC				
Display	5,7" touch screen				
Interfaces	2xUSB, 2xRS232, Ethernet, 4 Inputs / 4 Outputs, WIFI 2,4GHz b,g,n				
Net / Gross weight	2,7 / 3,6kg				
Package dimensions	490 x 300 x 150mm				

Technical data:	WLY 6/F1/R	WLY 12/F1/R	WLY 30/F1/R	WLY 60/C2/R	WLY 120/C2/R
	WLY 6/F1/K	WLY 12/F1/K	WLY 30/F1/K	WLY 60/C2/K	WLY 120/C2/K
		M	-	-	M
Maximum capacity	6kg	12kg	30kg	60kg	120kg
Minimum capacity	5g	-	-	50g	-
Reading division [d]	0,1g	0,2g	0,5g	1g	2g
Verification interval [e]	1g	-	-	10g	-
Tare range	-6kg	-12kg	-30kg	-60kg	-120kg
Repeatability	0,1g	0,6g	1,5g	1g	6g
Linearity	±0,1g	±0,6g	±1,5g	±1g	±6g
OIML Class	II		-	II	
Pan size	300 x 300mm			400 x 500mm	
Stabilization time	3s				
Operation temperature	+15°C to +30°C				
Storage temperature	-25°C to +70°C				
Atmospheric humidity	10÷85% RH no condensation				
Ingress protection rating	IP 43				
Power supply	100÷240VAC 50/60Hz – 12VDC				
Display	5,7" touch screen				
Interfaces	2xUSB, 2xRS232, Ethernet, 4 Inputs / 4 Outputs, WIFI 2,4GHz b,g,n				
Net / Gross weight	5,2 / 6kg			12,5 / 15kg	
Package dimensions	570 x 390 x 170mm			720 x 580 x 220mm	

41.2. Scales of WPY series

Technical data:	WPY 0,6/D2	WPY 1,5/D2	WPY 3/D2	WPY 6/D2
	M	M	M	M
Maximum capacity	0,6kg	1,5kg	3kg	6kg
Minimum capacity	4g	10g	20g	40g
Reading division [d]	0,2g	0,5g	1g	2g
Verification interval [e]	0,2g	0,5g	1g	2g
Tare range	-0,6kg	-1,5kg	-3kg	-6kg
Repeatability	0,2g	0,5g	1g	2g
Linearity	±0,2g	±0,5g	±1g	±2g
Stabilization time	2s			
OIML Class	III			
Pan size	195 x 195mm			
Operation temperature	-10°C to +40°C			
Storage temperature	-25°C to +70°C			
Atmospheric humidity	10÷85% RH no condensation			
Ingress protection rating	IP 43			
Power supply	100÷240VAC 50/60Hz – 12VDC			
Display	5,7" touch screen			
Interfaces	2xUSB, 2xRS232, Ethernet, 4 Inputs / 4 Outputs, WIFI 2,4GHz b,g,n			
Net / Gross weight	2,7 / 3,6kg			
Package dimensions	490 x 300 x 150mm			

Technical data:	WPY 6/F1/R	WPY 15/F1/R	WPY 30/F1/R	WPY 30/C2/R	WPY 60/C2/R
	WPY 6/F1/K	WPY 15/F1/K	WPY 30/F1/K	WPY 30/C2/K	WPY 60/C2/K
	M	M	M	M	M
Maximum capacity	6kg	15kg	30kg	30kg	60kg
Minimum capacity	40g	100g	200g	200g	400g
Reading division [d]	2g	5g	10g	10g	20g
Verification interval [e]	2g	5g	10g	10g	20g
Tare range	-6kg	-15kg	-30kg	-30kg	-60kg
Repeatability	2g	5g	10g	10g	20g
Linearity	±2g	±5g	±10g	±10g	±20g
Pan size	300 x 300mm			400 x 500mm	
Stabilization time	2s				
OIML Class	III				
Operation temperature	-10°C to +40°C				
Storage temperature	-25°C to +70°C				
Atmospheric humidity	10÷85% RH no condensation				
Ingress protection rating	IP 43				
Power supply	100÷240VAC 50/60Hz – 12VDC				
Display	5,7" touch screen				
Interfaces	2xUSB, 2xRS232, Ethernet, 4 Inputs / 4 Outputs, WIFI 2,4GHz b,g,n				
Net / Gross weight	5,2 / 6kg			12,5 / 15kg	
Package dimensions	570 x 390 x 170mm			720 x 580 x 220mm	

Technical data:	WPY 150/C2/K	WPY 300/C2/K	WPY 150/C3/K	WPY 300/C3/K
	WPY 150/C2/R	-	-	-
	M	M	M	M
Maximum capacity	150kg	300kg	150kg	300kg
Minimum capacity	1kg	2kg	1kg	2kg
Reading division [d]	50g	100g	50g	100g
Verification interval [e]	50g	100g	50g	100g
Tare range	150kg	-300kg	150kg	-300kg
Repeatability	50g	100g	50g	100g
Linearity	±50g	±100g	±50g	±100g
Stabilization time	2s			
OIML Class	III			
Pan size	400 x 500mm		500 x 700mm	
Operation temperature	-10°C to +40°C			
Storage temperature	-25°C to +70°C			
Atmospheric humidity	10÷85% RH no condensation			
Ingress protection rating	IP 43			
Power supply	100÷240VAC 50/60Hz – 12VDC			
Display	5,7" touch screen			
Interfaces	2xUSB, 2xRS232, Ethernet, 4 Inputs / 4 Outputs, WIFI 2,4GHz b,g,n			
Net / Gross weight	12,5 / 15kg		20,5 / 26,8kg	
Package dimensions	720 x 580 x 220mm		820 x 640 x 260mm	

41.3. Scales of WLY/KTP series

Technical data:	WLY 0,6/1,2/KTP/D2	WLY 3/6/KTP/D2	WLY 6/12/KTP/D2
	M	M	M
Maximum capacity	0,6 / 1,2kg	3 / 6kg	6 / 12kg
Minimum capacity	5g	25g	50g
Reading division [d]	0,1 / 0,2g	0,5 / 1g	1 / 2g
Verification interval [e]	0,1 / 0,2g	0,5 / 1g	1 / 2g
Tare range	-1,2kg	-6kg	-12kg
Repeatability	0,1 / 0,2g	0,5 / 1g	1 / 2g
Linearity	±0,1 / 0,2g	±0,5 / 1g	±1 / 2g
Stabilization time	3s		
OIML Class	II		
Pan size	195 x 195mm		
Operation temperature	+15°C to +30°C		
Storage temperature	-25°C to +70°C		
Atmospheric humidity	10÷85% RH no condensation		
Ingress protection rating	IP 43		
Power supply	100÷240VAC 50/60Hz – 12VDC		
Display	5,7" touch screen		
Interfaces	2xUSB, 2xRS232, Ethernet, 4 Inputs / 4 Outputs, WIFI 2,4GHz b,g,n		
Net / Gross weight	2,7 / 3,6kg		
Package dimensions	490 x 300 x 150mm		

Technical data:	WLY 6/12/KTP/F1/R	WLY 12/30/KTP/F1/R	WLY 60/KTP/C2/R	WLY 60/120/KTP/C2/R
	WLY 6/12/KTP/F1/K	WLY 12/30/KTP/F1/K	WLY 60/KTP/C2/K	WLY 60/120/KTP/C2/K
	M	M	M	M
Maximum capacity	6 / 12kg	12 / 30kg	60kg	60 / 120kg
Minimum capacity	50g	100g	0,5kg	0,5kg
Reading division [d]	1 / 2g	2 / 5g	10g	10 / 20g
Verification interval [e]	1 / 2g	2 / 5g	10g	10 / 20g
Tare range	-12kg	-30kg	-60kg	-120kg
Repeatability	1 / 2g	2 / 5g	10g	10 / 20g
Linearity	±1 / 2g	±2 / 5g	±10g	±10 / 20g
Stabilization time	3s			
OIML Class	II			
Pan size	300 x 300mm		400 x 500mm	
Operation temperature	+15°C to +30°C			
Storage temperature	-25°C to +70°C			
Atmospheric humidity	10÷85% RH no condensation			
Ingress protection rating	IP 43			
Power supply	100÷240VAC 50/60Hz – 12VDC			
Display	5,7" touch screen			
Interfaces	2xUSB, 2xRS232, Ethernet, 4 Inputs / 4 Outputs, WIFI 2,4GHz b,g,n			
Net / Gross weight	5,2 / 6kg		12,5 / 15kg	
Package dimensions	570 x 390 x 170mm		720 x 580 x 220mm	

41.4. Scales of WPY/KTP series

Technical data:	WPY 0,6/1,5/KTP/D2	WPY 1,5/3/KTP/D2	WPY 3/6/KTP/D2
	M	M	M
Maximum capacity	0,6 / 1,5kg	1,5 / 3kg	3 / 6kg
Minimum capacity	4 / 10g	10 / 20g	40 / 40g
Reading division [d]	0,2 / 0,5g	0,5 / 1g	1 / 2g
Verification interval [e]	0,2 / 0,5g	0,5 / 1g	1 / 2g
Tare range	-1,5kg	-3kg	-6kg
Repeatability	0,2 / 0,5g	0,5 / 1g	1 / 2g
Linearity	±1 / 2g	±1 / 2g	±1 / 2g
Stabilization time	2s		
OIML Class	III		
Pan size	195 x 195mm		
Operation temperature	-10°C to +40°C		
Storage temperature	-25°C to +70°C		
Atmospheric humidity	10÷85% RH no condensation		
Ingress protection rating	IP 43		
Power supply	100÷240VAC 50/60Hz – 12VDC		
Display	5,7" touch screen		
Interfaces	2xUSB, 2xRS232, Ethernet, 4 Inputs / 4 Outputs, WIFI 2,4GHz b,g,n		
Net / Gross weight	2,7 / 3,6kg		
Package dimensions	490 x 300 x 150mm		

Technical data:	WPY 3/6/KTP/F1/K	WPY 6/15/KTP/F1/K	WPY 15/30/KTP/F1/K
	WPY 3/6/KTP/F1/R	WPY 6/15/KTP/F1/R	WPY 15/30/KTP/F1/R
	M	M	M
Maximum capacity	3 / 6kg	6 / 15kg	15 / 30kg
Minimum capacity	20 / 40g	40 / 100g	100 / 200g
Reading division [d]	1 / 2g	2 / 5g	5 / 10g
Verification interval [e]	1 / 2g	2 / 5g	5 / 10g
Tare range	-6kg	-15kg	-30kg
Repeatability	1 / 2g	2 / 5g	5 / 10g
Linearity	±1 / 2g	±2 / 5g	±5 / 10g
Stabilization time	2s		
OIML Class	III		
Pan size	300 x 300mm		
Operation temperature	-10°C to +40°C		
Storage temperature	-25°C to +70°C		
Atmospheric humidity	10÷85% RH no condensation		
Ingress protection rating	IP 43		
Power supply	100÷240VAC 50/60Hz – 12VDC		
Display	5,7" touch screen		
Interfaces	2xUSB, 2xRS232, Ethernet, 4 Inputs / 4 Outputs, WIFI 2,4GHz b,g,n		
Net / Gross weight	5,2 / 6kg		
Package dimensions	570 x 390 x 170mm		

Technical data:	WPY 15/30/KTP/C2/K	WPY 30/60/KTP/C2/K
	WPY 15/30/KTP/C2/R	WPY 30/60/KTP/C2/R
	M	M
Maximum capacity	15 / 30kg	30 / 60kg
Minimum capacity	100 / 200g	200 / 400g
Reading division [d]	5 / 10g	10 / 20g
Verification interval [e]	5 / 10g	10 / 20g
Tare range	-30kg	-60kg
Repeatability	5 / 10g	10 / 20g
Linearity	±5 / 10g	±10 / 20g
Stabilization time	2s	
OIML Class	III	
Pan size	290 x 360mm	
Operation temperature	-10°C to +40°C	
Storage temperature	-25°C to +70°C	
Atmospheric humidity	10÷85% RH no condensation	
Ingress protection rating	IP 43	
Power supply	100÷240VAC 50/60Hz – 12VDC	
Display	5,7" touch screen	
Interfaces	2xUSB, 2xRS232, Ethernet, 4 Inputs / 4 Outputs, WIFI 2,4GHz b,g,n	
Net / Gross weight	12,5 / 15kg	
Package dimensions	720 x 580 x 220mm	

42. ERROR MESSAGES

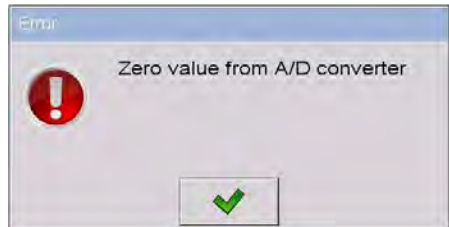
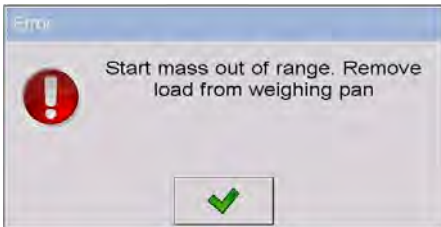
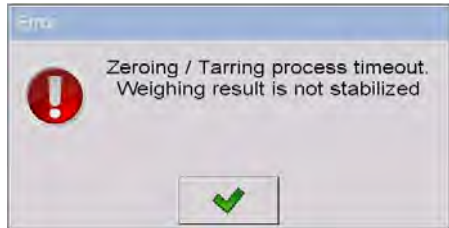
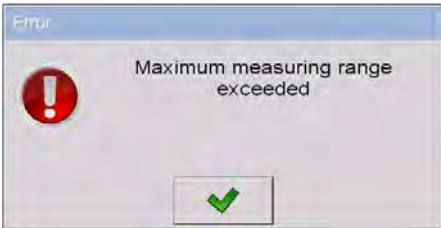
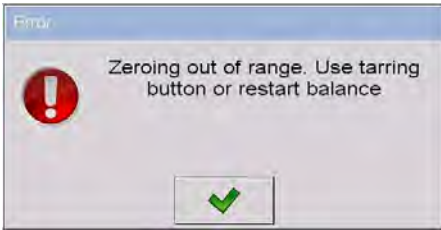

43. ADDITIONAL EQUIPMENT

Accessories:

- KAFKA printer cable - **P0136**,
- Computer cable - **P0108**,
- EPSON printer cable - **P0151**,
- Thermal printer - **KAFKA**,
- Dot matrix printer - **EPSON**,
- Label printer - **CITIZEN**,
- Additional display in plastic casing - **WD- 4/1**,
- Large size display (2") - **WWG-2**,
- Transponder card reader - **CK-01**,
- Barcode scanner - **LS2208**,

- Current loop in plastic casing - **AP2-1**,
- Handle for measuring indicator in plastic casing - **PUE-7-32**,
- PC keyboard.

Computer programs:

- “**E2R System**” computer program,
- „**PGC Viewer**” computer program,
- “**LABEL EDITOR R02**” computer program,
- “**DATABASE EDITOR PUE 7-HY**” computer program,
- “**RAD-KEY**” computer program,
- “**PW-WIN**” computer program.

44. APPENDIX A – Variables for printouts

44.1. Inventory of variables

Caution:

Every variable needs to be included in brace brackets e.g. {x}, where x – variable number.

A list of variables accessible in the system for defining printout templates and data displayed in the workspace of scale’s screen:

Symbol	Description
{0} ¹⁾	Standard printout in adjustment unit
{1} ¹⁾	Standard printout in current unit
{2}	Date
{3}	Time
{4}	Date & Time
{5}	Mathematical function
{6}	Net mass in current unit
{7}	Net mass in adjustment unit
{8}	Gross mass
{9}	Tare
{10}	Current unit
{11}	Adjustment unit
{12}	Minimum threshold
{13}	Maximum threshold
{14}	Lot number

{15}	Statistics: Number
{16}	Statistics: Sum
{17}	Statistics: Average
{18}	Statistics: Minimum
{19}	Statistics: Maximum
{20}	Cumulative of Cumulative Statistics: Quantity
{21}	Cumulative of Cumulative Statistics: Sum
{22}	Cumulative of Cumulative Statistics: Average
{23}	Cumulative of Cumulative Statistics: Min
{24}	Cumulative of Cumulative Statistics: Max
{25}	Mass: lb
{26}	Checkweighing
{27}	Value to pay
{28}	C Value (cumulative amount to pay)
{29}	CC value (cumulative of cumulatives amount to pay)
{30}	Gross (amount to pay + VAT)
{31}	Platform number
{32}	Factory Number
{33}	Scale division
{34}	Range
{35}	Counting pieces: Sample weight
{36}	Deviations: Sample weight
{37}	Statistics: Standard deviation
{38}	CC Statistics: Standard deviation
{39} ²⁾	Universal variable: Value
{40}	Text information
{41}	Batch number: Value
{42}	Statistics: Weighing counter
{43}	Platform mass
{44}	Balance type
{45}	Parts counting: Sample size
{46}	CC Statistics: Number of measurements
{47}	Statistics: Gross sum
{48}	CC Statistics: Gross sum
{49}	Universal variable: Name
{50}	Product: Name
{51}	Product: Code

{52}	Product: EAN Code
{53}	Product: Mass
{54}	Product: Tare
{55}	Product: Unit price
{56}	Product: Min
{57}	Product: Max
{58} ³⁾	Product: Testing Prepackages mode (CPG)
{59}	Product: Number of validity days
{60}	Product: VAT
{61}	Product: Date
{62}	Product: Expiry Date
{63} ³⁾	Product: Density
{64} ⁴⁾	Product: Ingredients
{65}	Product: Description
{66}	Product: Low deviation
{67}	Product: High deviation
{68}	Product: Category
{69}	Product: Expiry Date 1
{70}	Product: Expiry Date 2
{75}	Operator: Name
{76}	Operator: Code
{77}	Operator: Access level
{80}	Package: Name
{81}	Package: Code
{82}	Package: Mass
{85}	Client: Name
{86}	Client: Code
{87}	Client: Tax ID
{88}	Client: Address
{89}	Client: Postal code
{90}	Client: City
{91}	Client: Discount
{100}	Report From weighments: Measurements
{101}	Filter of weighments report: Start date
{102}	Filter of weighments report: End date
{103}	Filter of weighments report: Product
{104}	Filter of weighments report: Operator

{105}	Filter of weighments report: Client
{106}	Filter of weighments report: Package
{107}	Filter of weighments report: Min
{108}	Filter of weighments report: Max
{109}	Filter of weighments report: Lot number
{110}	Filter of weighments report: Batch number
{111}	Filter of weighments report: Target warehouse
{112}	Filter of weighments report: Source warehouse
{113}	Filter of weighments report: Checkweighing
{114}	Filter of weighments report: Platform number
{115}	Report From weighments: Number of weighments
{116}	Report From weighments: Totalized weighments
{117}	Report From weighments: Value
{118}	Report From weighments: Gross
{119}	Report From weighments: Average
{120}	Report From weighments: Min
{121}	Report From weighments: Max
{122}	Report From weighments: Vehicle scale
{130}	Source Warehouse: Name
{131}	Source Warehouse: Code
{132}	Source Warehouse: Description
{135}	Target warehouse: Name
{136}	Target warehouse: Code
{137}	Target warehouse: Description
{140}	Net mass in adjustment unit: Total
{141}	Additional display: WD
{142}	Additional display: WWG
{143}	Hex
{144}	Hex UTF8
{145}	Partial mass
{146}	Gross mass in current unit
{147}	Tare in current unit
{148}	Lot number: Name
{149}	Batch number: Name
{152}	Custom variable: Name
{153}	Custom variable: Value
{155}	Density: Start date

{156}	Density: End date
{157}	Density: Method
{158}	Density: Standard liquid
{159}	Density: Standard liquid density
{160}	Density: Temperature
{161}	Density: Sinker volume
{162}	Density
{163}	Density: Unit
{164}	Density: Sample number
{165}	Density: Weighing 1
{166}	Density: Weighing 2
{167}	Density: Weighing 3
{168}	Density: Volume
{169}	Density: Pycnometer mass
{170}	Density: Pycnometer density
{175}	Dosing process: Name
{176}	Dosing process: Code
{177}	Dosing process: Cycle number
{178}	Dosing process: Number of cycles
{180}	Dosing report: Start date
{181}	Dosing report: End date
{182}	Dosing report: Result
{183}	Dosing report: Number of measurements
{184}	Dosing report: Total
{185}	Dosing report: Measurements
{186}	Measurements: Nominal mass
{187}	Measurements: Difference
{205}	Adjustment track record: Nominal Mass
{206}	Adjustment track record: Platform number
{209}	Vehicle: Operator
{210}	Vehicle: Name
{211}	Vehicle: Code
{212}	Vehicle: Description
{213}	Vehicle scale: Start date
{214}	Vehicle scale: End date
{215}	Vehicle scale: Entry mass
{216}	Vehicle scale: Exit mass

{217}	Vehicle scale: Load mass
{218}	Vehicle scale: Transaction type
{219}	Vehicle scale: Status
{220}	Recipe: Name
{221}	Recipe: Code
{222}	Recipe: Cycle number
{223}	Recipe: Number of cycles
{224}	Recipe: Process progress
{225}	Recipe: Process progress in %
{226}	Recipe: Ingredient name
{227}	Recipe: Difference
{228}	Recipe: Portion
{229}	Recipe: Nominal mass
{230}	Recipe: Number of current ingredient
{231}	Recipe: Number of ingredient
{232}	Recipe: Number of current manufacturing unit
{233}	Recipe: Number of manufacturing unit
{234}	Recipe: Status
{235}	Recipe: Low deviation
{236}	Recipe: High deviation
{237}	Recipe: Ingredient code
{240}	Recipe: report: Start Date
{241}	Recipe: report: End Date
{242}	Recipe: report: Result
{243}	Recipe: report: Number of measurements
{244}	Recipe: report: Total
{245}	Recipe: report: Measurements
{246}	Measurements: Nominal mass
{247}	Measurements: Difference
{248}	Recipe report: Ingredient code
{249}	Recipe report: Ingredient weight entered manually
{260}	CPG Report: Batch Number
{261}	CPG Report: Start date
{262}	CPG Report: End date
{263}	CPG Report: Result
{264}	CPG Report: Lot quantity
{265}	CPG Report: Number of Measurements

{266}	CPG Report: T1 error border
{267}	CPG Report: 2T1 error border
{268}	CPG Report: Number of T1 errors
{269}	CPG Report: Acceptable number of T1 errors
{270}	CPG Report: Number of 2T1 errors
{271}	CPG Report: Total
{272}	CPG Report: Min
{273}	CPG Report: Max
{274}	CPG Report: Average
{275}	CPG Report: Limit of the average
{276}	CPG Report: Standard deviation
{277}	CPG Report: Measurements
{278}	CPG Report: Unit
{279}	CPG Report: Report Number
{280}	CPG Report: Value of T1 error [+]
{281}	CPG Report: Value of 2T1 error [+]
{282}	CPG Report: Number of T1 errors [+]
{283}	CPG Report: Permissible number of T1 errors [+]
{284}	CPG Report: Number of 2T1 errors [+]
{285}	CPG Report: Permissible number of 2T1 errors
{286}	CPG Report: Permissible number of 2T1 errors [+]
{287}	CPG Report: Navigating bar
{288}	CPG Report: Qualifying number of T1 errors
{289}	CPG Report: Tare
{290}	CPG Report: Average limit value [+]
{291}	CPG Report: Note
{292}	CPG Report: Density
{295}	Average Tare Report: Date
{296}	Average Tare Report: Result
{297}	Average Tare Report: Standard deviation
{298}	Average Tare Report: 0.25T1
{299}	Average Tare Report: Number of Measurements
{300}	Average Tare Report: Measurements
{301}	Average Tare Report: Report Number
{302}	Average Tare Report: Average Tare
{303}	Average Tare Report: Note
{320}	Identification process: Name

{321}	Identification process: Code
{330}	Differential weighing: Start date
{331}	Differential weighing: End date
{332}	Differential weighing: Number of weighments
{333}	Differential weighing: Measurements
{334}	Differential weighing: Measurement
{340}	Extra variable: Name
{341}	Extra variable: Value
{342}	Extra variable: Code
{350}	EPSON paper cutting
{351}	EPSON polish signs
{352}	Additional display: PUE7
{353}	IP Address
{354}	Code Page
{355}	Day-of-year
{356}	Number of packages
{357}	Mass to be dosed
{358}	Smart Connect
{359}	Working mode
{360}	Printer: Allergens start [pl]
{361}	Printer: Non allergens start [pl]
{362}	Printer: Allergens end
{363}	Printer: Allergens start [de]
{365}	Printer: Non allergens start [de]
{366}	Printer: Allergens start [es]
{367}	Printer: Non allergens start [es]
{368}	Printer: Allergens start [fr]
{369}	Printer: Non allergens start [fr]
{398}	Weighing

Caution:

- 1) Variables {0} and {1} is terminated by CR LF, i.e. the cursor is moved to the beginning of the next line by default,
- 2) In case of variable {39}, each position from the database (1,2-n) is formatted as follows: Position 1 - {39:1}, Position 2 - {39:2}, etc.
- 3) In case of variable {64}, each line (L1-Ln) is formatted according to the template: Line 1 - {64:L1}, Line 2 - {64:L2}, etc.

44.2. Formatting variables

Users can format numeric, text and date variables intended for displaying or printing out.

Different format commands:

- Justification to the left,
- Justification to the right,
- Setting the number of characters for printout / display,
- Declaration of the number of digital places for numeric variables,
- Date&Time formatting,
- Formatting numeric variables for EAN13 codes,
- Formatting numeric variables and dates for EAN128/GS1-128 codes.

Format characters:

Character	Description	Example
,	Separates variables from format strings	{7,10} – Net mass in adjustment unit situated in 10-character string justified to the right.
-	Minus sign or justification to the left	{7,-10} - Net mass in adjustment unit situated in 10-character string justified to the left
:	Provides formatting or separates hours, minutes and seconds	{7:0.000} - Net mass in adjustment unit always with three decimal places ; {3:hh:mm:ss} – Present time in the format : hours : minutes : seconds
.	The first dot in the format string determines the location of the decimal separator in the formatted value; any additional dot characters are ignored.	{55:0.00} – Unit price always with two decimal places; {17:0.0000} – Average value form weightings with four decimal places;
F	The number is converted to a string of the form "-ddd.ddd..." where each 'd' indicates a digit (0-9). The string starts with a minus sign if the number is negative.	{7:F2} - Net mass in adjustment unit always with two decimal places. {7,9:F2} - Net mass in adjustment unit always with two decimal places in 9-character string justified to the right.
V	Formatting mass and derivatives for EAN13 codes	{7:V6.3} - Net mass for EAN13 (6-character code) with three decimal characters
T	Formatowanie masy i wielkości pochodnych do masy w kodzie EAN128	{7:T6.3} – Net mass for EAN128/GS1-128 with two decimal places.

/	Date separator between days, months and years	{2:yy/MM/dd} – Present date formatted as: year - month - day, where yy represents two less significant digits of year.
\	„Escape” character removing formatting function form next character to allow it to be used as a character in a text string.	{2:yy\MM\dd} – Present date formatted as year / month / day; {2:yy\:MM\:dd} –Present date formatted as: year : month : day. In case of necessity of using „\” as literal it should be preceded by another escape character “\\”.

Format examples:

Symbol	Description
{7:V6.3}	Net mass for EAN 13 (6-character code)
{7:V7.3}	Net mass for EAN 13 (7-character code)
{27:V6.3}	Net amount to pay for EAN 13 (6-character code)
{27:V7.3}	Net amount to pay for EAN 13 (7-character code)
{7:T6.3}	Net mass for EAN 128/GS1-128
{16:T6.3}	Cumulative net mass for EAN 128/GS1-128
{21:T6.3}	Cumulative of cumulative net mass for EAN 128/GS1-128
{25:T6.3}	Net mass in lb for EAN 128/GS1-128
{8:T6.3}	Gross mass for EAN 128/GS1-128
{55:T6}	Product price for EAN 128/GS1-128
{2:yyMMdd}	Date for EAN 128/GS1-128
{61:yyMMdd}	Product date for EAN 128/GS1-128
{62:yyMMdd}	Expiary date for EAN 128/GS1-128
{16:V6.3}	Cumulative net mass for EAN 13 (6-character code)
{16:V7.3}	Cumulative net mass for EAN 13 (7-character code)
{28:V6.3}	Total/cumulative amount to pay for EAN 13 (6-character code)
{28:V7.3}	Total/cumulative amount to pay for EAN 13 (7-character code)
{21:V6.3}	Cumulative of cumulative net mass EAN 13 (6-character code)
{21:V7.3}	Cumulative of cumulative net mass EAN 13 (7-character code)
{29:V6.3}	Total/cumulative of cumulative amount to pay EAN 13 (6-character code)
{29:V7.3}	Total/cumulative of cumulative amount to pay EAN 13 (7-character code)

44.3. Mathematical function

Extended functionality of the mathematical functions with use of a variable **<{5} Mathematical function>** enables carrying out an optional operation on numbers and variables available on the list. The basic available mathematical functions are:

- Adding (+)
- Subtracting (-)
- Multiplying (*)
- Dividing (/)

The additional functionality provides using in the calculation the existing variables, thus enabling acquiring mass from a specified weighing platform, and its processing in a desired way.

An example:

{5: ([43:1] + [43:2]) / 2}

The above application of a variable **<{43} Platform mass>** causes acquiring mass from a weighing platform determined in the formatter (:1 and :2), and their dividing by 2 which enables taking the average mass from both weighing platforms. Use of the brackets enables carrying out the operation in an appropriate sequence and in accordance with basic mathematical principles.

Caution:

Variables in the structure of the mathematical operations are noted in square brackets [] and not as previously in { } brackets.

Additionally, a operator can use the advanced functions enabling extended means of data modification. The advanced functions are used in a form of text marker and arguments in brackets:

- round (numeric value, rounding precision (number)) - rounding
- abs (numeric value) – absolute value
- sin (numeric value) - sine
- cos (numeric value) - cosine
- tan (numeric value) - tangent
- sqrt (numeric value) - radical
- pow (numeric value, power base (number)) - power
- log (numeric value) – logarithm
- log10 (numeric value) – logarithm base 10

Caution:

A numeric value is comprehended as an optional number or an optional mathematical operation that returns a numeric value.

There are additional functions that modify the text values, and they can also operate on numbers that are converted to text:

- `remove` (“text value”, initial place (number), quantity of characters to be removed (number)) – a return is a residue after deleting a part of the text value, from the initial point to a determined quantity of characters. In case the third parameter is not specified the text value will be deleted till its end.
- `substring` (“text value”, initial place (number), quantity of characters to be copied (number)) – a return is copied text value from the initial point to a quantity of characters to be copied. In case the third parameter is not specified the text value will be copied till the end.
- `to lower` (“text value”) – a return is a complete text value in small letters.
- `to upper` (“text value”) – a return is a complete text value in capital letters.
- `replace` (“text value”, old text, new text) – a return is a text with replaced letters of parts of the text, determined in the second and their parameter.

Caution:

The text values are put in quotation marks “ ”.

Examples:



















`remove (“Text sample”,11)` – the operation causes returning a text value: “Text sample”.





















`to upper (“Text sample”)` – the operation causes returning a text value “TEXT SAMPLE”.



















`replace (“Text sample”, “text ”, “text”)` - the operation causes returning a text value “Text sample”.



















`replace (“2.000”, “0”, “1”)` - the operation causes returning a text value “2.111”. The value can be used for standard mathematical calculations, where it will be converted “on the fly” in case the operation requires it.

















45. APPENDIX B – Functions of programmable buttons













Icon	Function name
	ENTER
	Zero
	Tare
	Enter tare
	Parameters
	Local Parameters
	Set MIN and MAX
	Statistics (cumulative) : Print and zero
	Statistics (cumulative) : Print
	Statistics (cumulative) : zero
	Statistics (cumulative of cumulative): Print and zero
	Statistics (cumulative of cumulative): Print
	Statistics (cumulative of cumulative): zero
	Edit lot number
	Edit batch number
	Start
	Stop
	Choose an operator

	Choose an operator by name
	Choose an operator by code
	Choose a product
	Choose a product by name
	Choose a product by code
	Choose a package
	Choose a package by name
	Choose a package by code
	Choose a client
	Choose a client by name
	Choose a client by code
	Choose a source warehouse
	Choose a source warehouse by name
	Choose a source warehouse by code
	Choose a target warehouse
	Choose a target warehouse by name
	Choose a target warehouse by code
	Change working mode
	Counting pieces: Specify piece mass
	Counting pieces: Estimate piece mass

	Counting pieces: Ascribe standard
	Counting pieces: Quantity of sample - 5 pcs
	Counting pieces: Quantity of sample - 10 pcs
	Counting pieces: Quantity of sample - 20 pcs
	Counting pieces: Quantity of sample - 50 pcs
	Deviations: Specify sample mass
	Deviations: Estimate sample mass
	Emergency stop
	Chute permission
	Disable tare
	Restore tare
	Change unit
	Change platform
	Edit universal variable 1
	Edit universal variable 2
	Edit universal variable 3
	Select dosing process
	Select dosing process by name
	Select dosing process by code

	Select formulation
	Select formulation by name
	Select formulation by code
	Ingredients
	Determine liquid density
	Determine solid density
	Determine pycnometer density
	Determine porous body density
	Edit number of labels
	Edit number of C labels
	Edit number of CC labels
	PGC – Change: Workspace / chart
	PGC: Set control
	PGC: Return to home screen
	PGC: Average tare start
	PGC: Data on control in progress
	PGC: Edit note
	PGC: Finish control
	Choose a vehicle

	Choose a vehicle by name
	Choose a vehicle by code
	Choose a vehicle "manually"
	Start entry transaction
	Start exit transaction
	Choose transaction
	Choose traceability process
	Choose traceability process by name
	Choose traceability process by code
	Print Screen
	Select platform 1
	Select platform 2
	Select platform 3
	Select platform 4
	Choose an extra variable no 1
	Choose an extra variable no 2
	Choose an extra variable no 3

	Choose an extra variable no 4
	Choose an extra variable no 5
	Zero platform 1
	Zero platform 2
	Zero platform 3
	Zero platform 4
	Tare platform 1
	Tare platform 2
	Tare platform 3
	Tare platform 4
	Undo weighing
	Increase accuracy
	Select record from the database

46. APPENDIX C – Label template





A label template can be created in 2 ways:

- From the terminal level using variables,
- Using PC software **EDYTOR ETYKIET R02**. A created project needs to be saved as an „lb” file then copied on a pen drive that can be connected to the terminal. Finally transfer the file to the database in the scale.

While a label is in the database of labels it can be ascribed to products or/and clients in order to work in labelling mode.

46.1. Designing a label from the terminal level

Procedure:

- Enter  **Databases**> according to ch. 34 of this manual,
- Enter  **Labels**> and press on the required position.
- After entering  **Label template**> an editing field with the screen keyboard appears
- Modify the existing template using the list of variables accessible after pressing ,
- Confirm changes by pressing .

Caution:

In the bottom line of the screen keyboard there are additional buttons that help to modify a label template:



On-screen keyboard on / off



*Read label templates from *.lb files (see – ch. 45.3)*



*Saving printout template in a file format *.lb (option enabled on plugging a portable data storage device to scale port)*



Select variables for the display template (inventory of variables can be found in APPENDIX A)



Clearing the editing field

46.2. Designing a label on a computer

Example:

Let us create a label template for the label below:



Caution:

The installer of **EDYTOR ETYKIET R02** is accessible to download on website: **www.radwag.com**. on the overlap: Products / Measuring indicators / PUE 7.1.

Procedure:

3. Run computer program **LABEL EDITOR R02**, then the main window of the program is displayed:

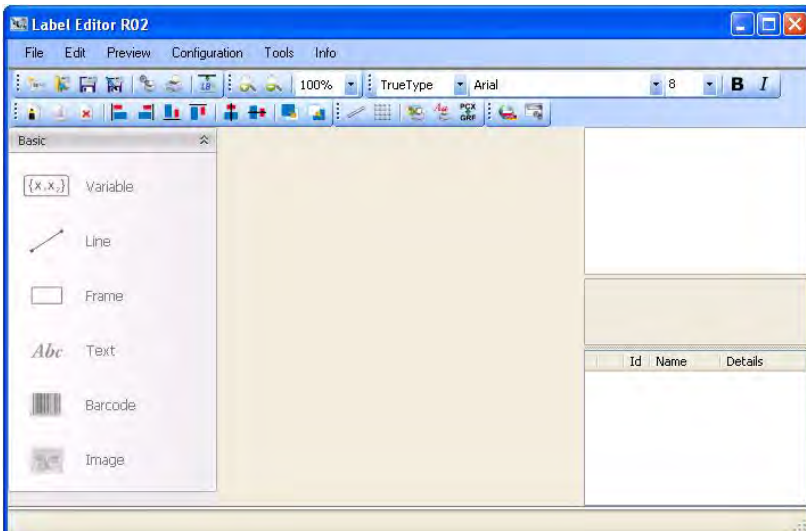

Caution:

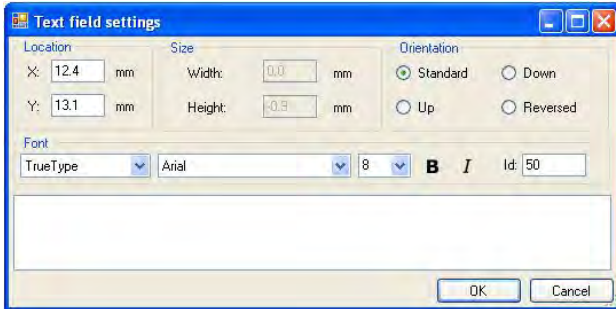

Prior to designing a label a new project needs to be created with initial printer and label settings. A description of creating new projects can be found in instruction manual „Label Editor R02” accessible in the program menu: „Info / User manual”.

- 4. In order to add a text to the label chose **<Abc Text>** from the list of objects and then click on the workspace of label, then window **<Text field settings>** opens:



- 5. Type the required text in the box at the bottom of the window: PORK CHARCUTERIE SMITH&SMITH Ltd and press **OK** to confirm, then the text is put automatically on the label,
- 6. In order to add a variable to the label chose **<{x,x2} Variable>** from the list of objects and then click on the workspace of label, then window **<Variable settings>** opens:



7. From list **<Variable>** chose variable type „**4 Date and time**” and press , then the variable is placed in the table of variables show below.
8. Confirm it by pressing , then the variable is automatically placed on the label.
9. Place the rest of variables and constant texts on the label in the same way,
10. In order to put an image on the label chose  **<Image>** from the list of objects and then click on the workspace of label, then window **<Open>** opens:

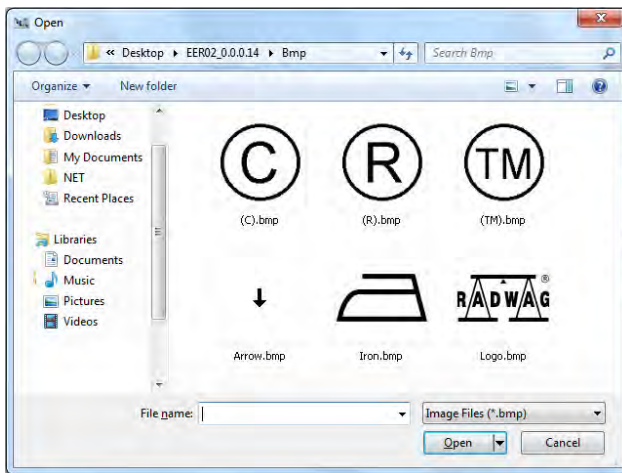

11. Chose one and press **<Open>**, then the image is placed on the label.

Caution:

Graphic images placed on the label can be printed only when they are downloaded to the printer memory. It is described in the instruction manual „Label Editor R02” accessible in the program menu on the overlap: „Info / User manual”.

12. In order to add a barcode to the label chose  **<Barcode>** and then click on the workspace of label, then window **<Barcode settings>** opens:

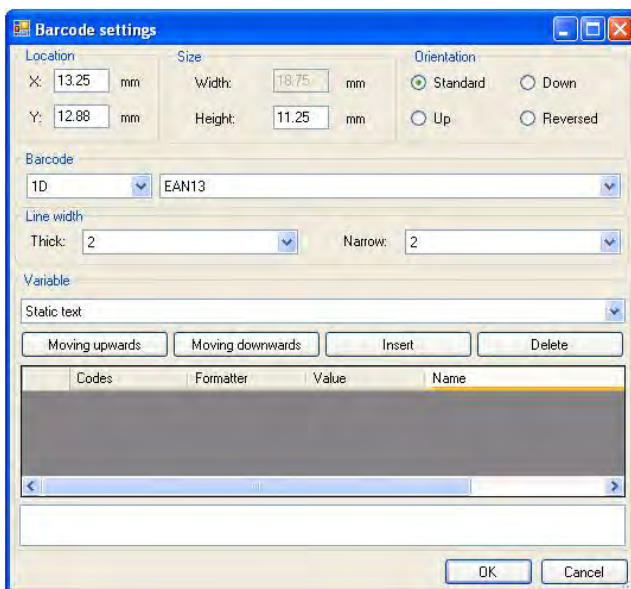







13. Chose **<Barcode>** from the list e.g. **EAN-13**.
14. Chose from list **<Variable>** item „**7 Net mass in adjustment unit**” and press , then the variable is placed in the table of variables show below.
15. In column **<Formatter>** type: **V6.3** (mass in EAN13 as a 6-digit code with 3 decimal places).
16. Confirm the entered item by pressing , then the barcode is automatically placed on the label.
17. Save the created pattern choosing from the menu „**File / Export *.lb**”.

Caution:

*Recorded templates of labels in files with *.lb extension are not editable. This is advisable to record designs of labels in files with *.lab extension as well (software menu: File / Save as...) to use/edit the designs of labels in the future.*

46.3. Saving label templates in the scale

Procedure:



- A label template *.lb created in **EDYTOR ETYKIET R02** needs to be copied to a pen drive,
- Connect the pen drive to USB in the scale,
- Enter: „ /  **Databases** /  **Labels**” and press the required item,
- Enter < **Label templates**>, then an editing field and the screen keyboard appears,
- Press , to open a window showing files on the pen drive,
- Select the required *.lb file. It is automatically copied to the editing field,
- Confirm the changes by pressing .

Caution:

If a pen drive is not recognized by the system button  will remain inactive.



46.4. Attributing a label to a product

Procedure:

- Enter < **Databases**> according to ch. 34 of this manual,
- Enter < **Products**> and press the required item,
- Enter < **Label**>, then the database of labels is open with the list of all labels,
- Choose the required label. The program automatically ascribes the label to the product.





46.5. Attributing a label to a client

Procedure:

- Enter <  **Databases**> according to ch. 34 of this manual,
- Enter <  **Clients**> and press the required item,
- Enter <  **Label**>, then the database of labels is open with the list of all labels,
- Choose the required label. The program automatically ascribes the label to the client.

46.6. Printing labels

Procedure:

- While in the main window choose a product (button ) or a client (button ) that has attributed a label,
- Place a load on the pan and wait for  then press ,
- The label is printed on a printer connected to the scale.

Caution:

1. *Labels can be attributed to products or/and clients. After pressing  a label is printed on a connected printer, provided a selected client or product has an ascribed label.*
2. *Users can perform the test label printout – see ch. 34.5 of this manual.*

47. APPENDIX D - CITIZEN printer setting

Baud rate : **9600b/sec**
Parity control : **No**
Number of data bits : **8bit**
Number of stop bits : **1 bit**
Flow control : **No**
IEEE 1284 : **ON**

Information printed by the printer via RS232:

[Interface Menu]

RS-232C Baud rate : **9600bps**
RS-232C Parity : **None**
RS-232C Length : **8 bit**
RS-232C Stop bit : **1 bit**
RS-232C X-ON : **No**
IEEE 1284 : **On**

The way of generating the setup printout and setting CITIZEN printers are described in manuals attached to printers or present on the website of the manufacturer.

48. APPENDIX E - ZEBRA printer setting

Baud rate – 9600b/sec
Parity control – none
No of data bits – 8bit
No of stop bits – 1 bit

Information printed by the printer via RS232:

Serial port : **96, N, 8, 1**

The way of generating the setup printout and setting ZEBRA (Eltron) printers are described in manuals attached to printers or present on the website of the manufacturer.

49. APPENDIX F - Communication with barcode scanners

1. For communication with barcode scanners RADWAG scales use RS232 interfaces and simplex transmission (one direction) without handshaking. Only two wires are required for assuring such a transmission. Used scanners should be equipped in such interface with disabled both hardware and software handshaking.
2. Both scales and scanners have the possibility of setting of transmission parameters. Both devices are required to have the same parameters set : baud rate, number of data bits, parity control, stop bits. e.g. 9600,8,N,1 – baud rate 9600 bit/s, data 8-bits, no parity control, 1 stop bit.

3. Barcode scanners can send additional information apart from the expected barcode e.g. symbology (type of barcode). It is advisable to disable such information because RADWAG devices and software do not use it.
4. Some RADWAG systems can omit unnecessary information by using parameters that mark the beginning and the length of the code required to analyse.
5. A special protocol is required in order the code be received by RADWAG equipment. It is required to program an appropriate *prefix and suffix*. Prefix – one byte 01 hexadecimally, suffix one byte 0D hexadecimally.
6. Most barcode scanners allow to enable/disable different symbologies (barcode types).
7. Programming of scanners is usually performed by reading special barcodes or by using an external software tool.
8. Scanners marketed together with RADWAG systems are always configured according to the rules above.

Barcode with required prefix and suffix in hexadecimal format	Barcode without required –fixes in ASCII format	Code type
01 30 30 32 31 30 31 32 36 0D	00210126	EAN-8
01 30 31 32 33 34 35 36 37 38 39 0D	0123456789	2 of 5
01 43 4F 44 45 20 33 39 20 54 45 53 54 0D	CODE 39 TEST	CODE 39
01 31 31 30 31 32 33 34 35 36 37 38 39 31 0D	1101234567891	EAN-13
01 43 6F 64 65 20 31 32 38 20 54 65 73 74 0D	CODE 128 Test	CODE 128

50. APPENDIX G – Computer Program „PGC Viewer”

Computer program „PGC Viewer” is intended for viewing and printing reports from controls and average tare tests.

Caution:





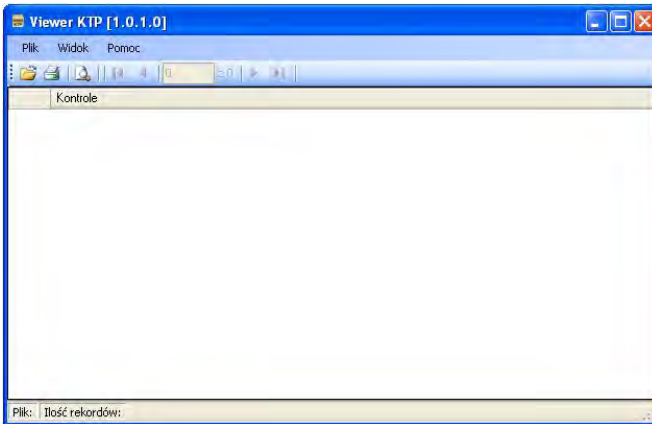

Installation program „PGC Viewer” is recorded on the CD connected to this product.

Operation description:

- Run computer program „**PGC Viewer**”. It starts with opening the following window:





Button functions:

-  Open a controls or average tares database
-  Print a report
-  View a report
-  Scroll the list of reports one position down
-  Scroll the list of reports one position up
-  Go to the last report
-  Go to the first report

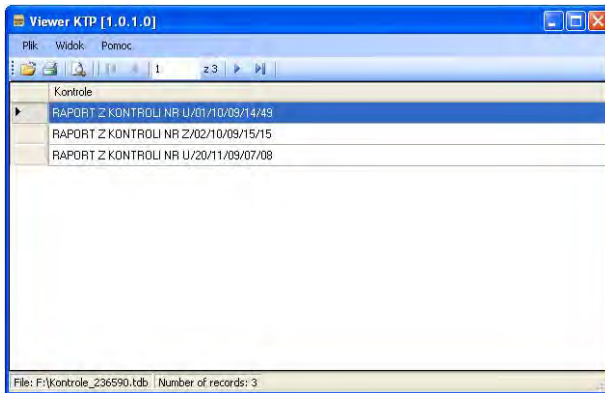
- Press , then window **<Open>** appears in which the wanted database can be located (extension *.tdb),
- Mark a report and click on ,
- The program automatically returns to the main window and in the field **<Tests>** the list of reports is displayed:



- Print the marked report on a connected printer by pressing ,
- Using button  view the selected report.

MANUFACTURER
OF ELECTRONIC WEIGHING INSTRUMENTS



RADWAG WAGI ELEKTRONICZNE
26 – 600 Radom, Bracka Street 28
POLAND
Phone +48 48 38 48 800, fax. + 48 48 385 00 10
e-mail: export@radwag.com
www.radwag.com

