

PM Series Balances

Precision balances of **PM xx.C32** series

USER MANUAL

IMMU-23-13-02-21-EN



Congratulations and thank you for selecting RADWAG product.
You have purchased a device that has been designed and manufactured to give you years of service.
Please read this User Manual carefully, this shall guarantee reliable operation.

PM series balances are based on the below technology:

 **MONOBLOCK[®]**

FEBRUARY 2021

"The drawings, photos and graphics
used are for illustrative purposes only."

Contents

1. GENERAL INFORMATION.....	8
1.1. Dimensions	8
1.2. Connectors Arrangement.....	10
1.3. Diagrams of Connection Cables	10
1.4. Intended Use	10
1.5. Precautions	10
1.6. Warranty Conditions	11
1.7. Supervision Over Metrological Parameters	12
1.8. User Manual Significance.....	12
1.9. Balance Operator Training	12
2. TRANSPORT AND STORAGE.....	12
2.1. Delivery Check.....	12
2.2. Packaging.....	12
3. UNPACKING AND INSTALLATION.....	12
3.1. Place of Use.....	12
3.2. Standard Delivery Components List	13
3.3. Unpacking	13
3.4. Levelling	13
3.5. Maintenance Activities	15
3.6. Connecting the Weighing Instrument to the Mains.....	16
3.7. Temperature Stabilization Time.....	16
3.8. Connecting Additional Hardware.....	17
4. START-UP	17
5. OPERATION PANEL.....	17
6. HOME SCREEN.....	18
6.1. Top Bar.....	18
6.2. Weighing Result Window	19
6.3. Workspace	19
6.4. Pictograms	19
7. OPERATING THE MENU	20
7.1. Entering the Menu	20
7.2. Menu Keys	20
7.3. Entering Numeric and Text Characters and Signs	21
7.3.1. Numerical Box	21
7.3.2. Text Box	22
7.3.3. Diacritical Signs Table.....	23
7.3.4. Special Signs Table	24
7.4. Return to the Weighing Mode.....	24
8. DISPLAY.....	24
8.1. Workspace	24
8.1.1. Label	25
8.1.2. Text Box	26
8.1.3. Bar Graph	26
8.2. Keys.....	28
8.3. Default Screen Settings.....	29
9. OUTPUTS / INPUTS.....	30

9.1. Input Setup	30
9.2. Output Setup	30
10. PROGRAM.....	31
11. LOG IN OPERATION.....	31
12. WEIGHING OPERATION.....	32
12.1. Good Weighing Practice.....	32
12.2. Units.....	33
12.3. Weighing Unit Selection	33
12.4. Weighing Units Accessibility.....	34
12.5. Start Unit Selection	34
12.6. Gravitational Acceleration.....	34
12.7. Custom Units	35
12.8. Zeroing Operation	35
12.9. Taring Operation	35
12.10. Weighing Profile.....	37
12.11. WEIGHING Mode Settings- Readout.....	39
12.12. Proximity Sensors	40
12.13. AUTOTARE	40
12.14. Print Mode.....	41
12.15. Minimum Sample Weight.....	42
13. MISCELLANEOUS PARAMETERS	44
14. PERMISSIONS LEVELS	48
14.1. Anonymous Operator	48
14.2. Date and Time	48
14.3. Printouts	48
14.4. Databases Edition.....	48
14.5. Select Database Record	49
15. ADJUSTMENT	49
15.1. Internal Adjustment	49
15.2. External Adjustment	50
15.3. Operator's Adjustment	50
15.4. Adjustment Test.....	50
15.5. Automatic Adjustment	50
15.6. Automatic Adjustment Time.....	51
15.7. Print	51
16. PRINTOUTS CONTENT	51
16.1. Adjustment Report	51
16.2. Header, Footer, GLP Printouts	52
16.3. Non-Standard Printouts.....	54
16.3.1. Inserting Texts	54
16.4. Variables	57
17. WORKING MODES – General Information.....	57
17.1. Working Modes Accessibility	58
17.2. Running Working Mode	58
17.3. Working Mode Parameters.....	59
18. PARTS COUNTING	59

18.1. Mode Related Settings	59
18.2. Parts Counting – Quick Access Keys.....	60
18.3. Setting Reference Sample Mass by Entering Mass of a Single Part	60
18.4. Setting Reference Sample Mass by Determining Mass of a Single Part.....	60
18.5. Setting Reference Sample Mass by Acquiring Mass of a Single Part from Database	62
18.6. Parts Counting Procedure	62
19. CHECKWEIGHING	63
19.1. Mode Related Settings	63
19.2. Checkweighing – Quick Access Keys	63
19.3. Making Use of Checkweighing Thresholds	64
20. DOSING	65
20.1. Mode Related Settings	65
20.2. Dosing – Quick Access Keys.....	65
20.3. Making Use of Products Database in the Course of Dosing Operation	65
21. PERCENT WEIGHING AGAINST REFERENCE SAMPLE MASS	66
21.1. Mode Related Settings	68
21.2. Percent Weighing – Quick Access Keys.....	68
21.3. Mass Comparison of the Sample and the Reference Sample.....	68
22. SOLIDS DENSITY	70
22.1. Mode Related Settings	70
22.2. Solids Density – Quick Access Keys	70
22.3. Solids Density Determination	71
23. LIQUIDS DENSITY	72
23.1. Mode Related Settings	73
23.2. Liquids Density – Quick Access Keys.....	73
23.3. Liquids Density Determination.....	73
24. ANIMAL WEIGHING.....	74
24.1. Mode Related Settings	74
24.2. Animal Weighing – Quick Access Keys.....	75
25. STATISTICS	76
25.1. Mode Related Settings	76
25.2. Statistics – Quick Access Keys	76
25.3. Measurement Series Parameters	77
26. PEAK HOLD	77
26.1. Mode Related Settings	78
26.2. Peak Hold – Quick Access Keys	78
26.3. Means of Operation	78
27. FORMULATIONS	79
27.1. Mode Related Settings	79
27.2. Formulations – Quick Access Keys	80
27.3. Adding Formulation to Formulations Database	80
27.4. Using Formulations in the Course of Weighing.....	81
27.5. Performed Formulations Report.....	87
28. BASIC TOTALIZING.....	88
28.1. Mode Related Settings	88

28.2. Basic Totalizing – Quick Access Keys.....	88
28.3. Procedure.....	88
29. DATABASES.....	89
29.1. Database Connected Operations.....	90
29.1.1. Adding a New Record.....	90
29.1.2. Export.....	90
29.1.3. Import.....	90
29.1.4. Delete a Record.....	91
29.1.5. Delete a Database.....	91
29.2. Products.....	91
29.3. Operators.....	92
29.4. Packaging.....	92
29.5. Customers.....	92
29.6. Formulations.....	92
29.7. Universal variables.....	92
30. REPORTS.....	93
30.1. Formulations Reports.....	93
30.2. Ambient Conditions.....	94
30.3. Weighings.....	94
30.4. Alibi.....	95
31. COMMUNICATION.....	95
31.1. RS232 Ports Settings.....	95
31.2. ETHERNET Port Settings.....	96
31.3. Wireless Communication Settings.....	96
31.4. USB Ports.....	98
32. PERIPHERAL DEVICES.....	101
32.1. Computer.....	101
32.2. Printer.....	103
32.3. Record of Measurement Data Onto a USB Flash Drive.....	106
32.4. Barcode Scanner.....	106
32.4.1. Barcode Scanner Port.....	107
32.4.2. Offset.....	107
32.4.3. Length of Code.....	107
32.4.4. Prefix, Suffix.....	107
32.4.5. Field Selection.....	107
32.4.6. Filtering.....	108
32.4.7. Test.....	108
32.5. Additional Display.....	108
32.6. Ambient Conditions Module.....	109
33. AMBIENT CONDITIONS.....	110
34. COMMUNICATION PROTOCOL.....	112
34.1. List of Commands.....	112
34.2. Response Format.....	113
34.3. Manual Printout / Automatic Printout.....	127
35. PERIPHERAL DEVICES.....	128
36. ERROR MESSAGES.....	128
37. ADDITIONAL EQUIPMENT.....	130

38. BALANCE DATA..... 130
39. APPENDIX 01 - Communication with Barcode Scanner 130

1. GENERAL INFORMATION

1.1. Dimensions

PM xx.C32, d=0.01g

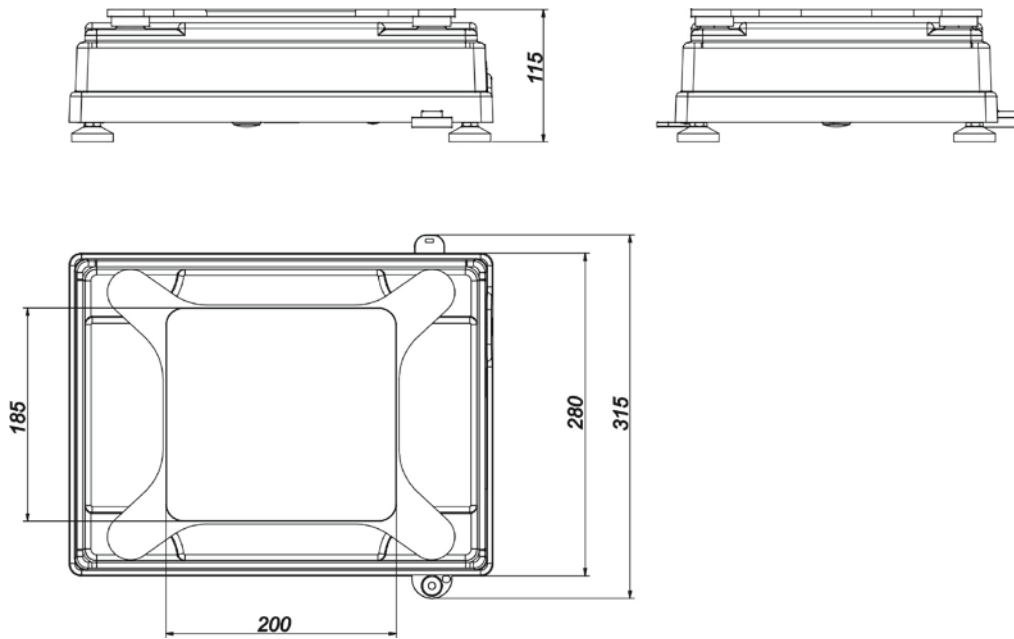

PM xx.C32, d=0.1g

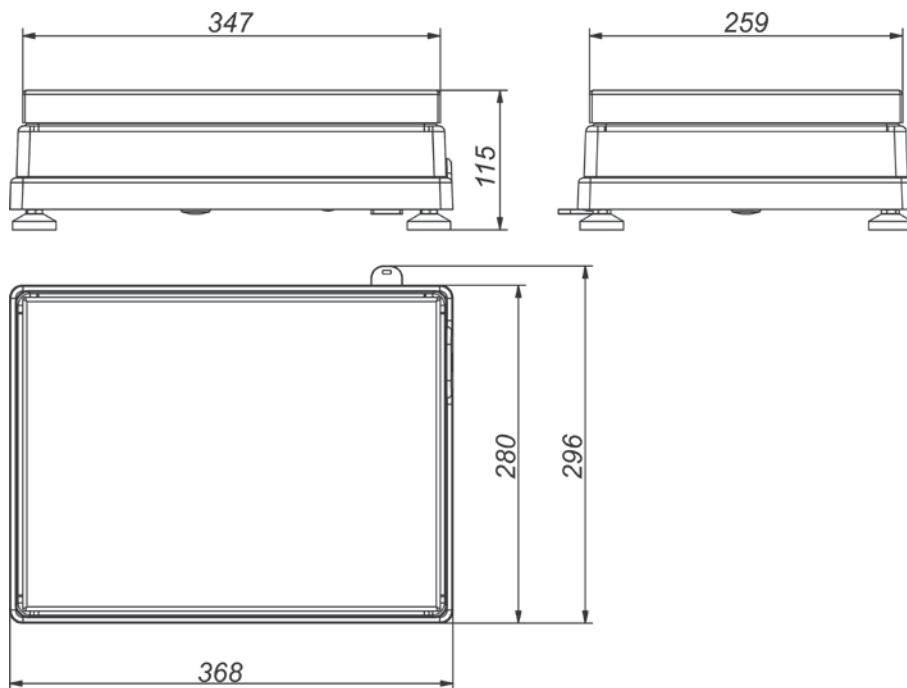

PM xx.C32, d=0.5g, d=1g

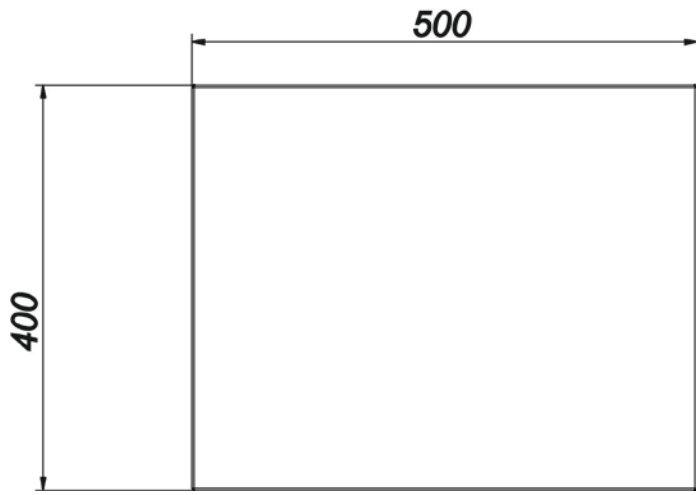
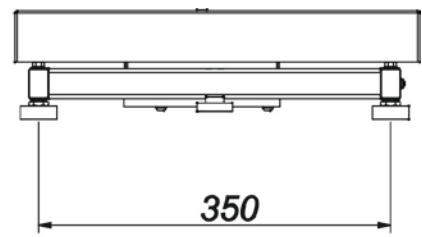
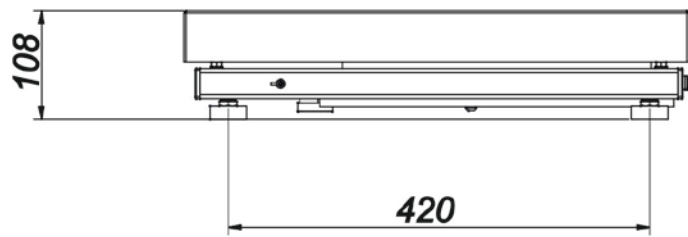

Indicator

1.2. Connectors Arrangement

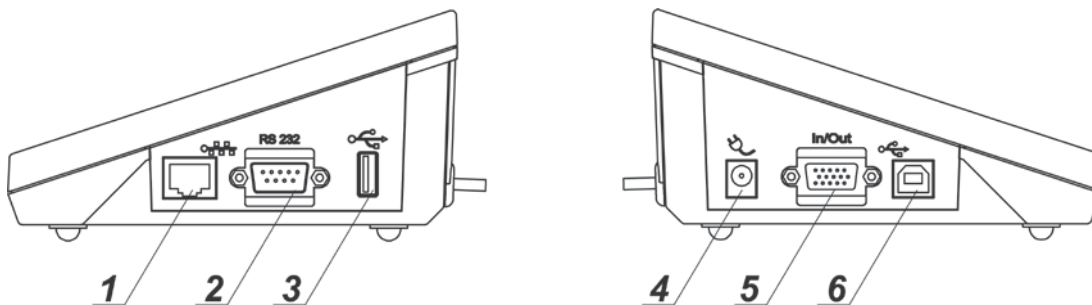

- 1 – Ethernet RJ45 connector
- 2 – RS232 (COM1) connector
- 3 – USB type A connector

- 4 – power supply socket
- 5 – RS232 (COM2) connector
- 6 – USB type B connector

1.3. Diagrams of Connection Cables

Caution: "Ethernet – weighing device" cable is a standard network cable terminated with RJ45 connectors on both ends.

<p>COMPUTER</p> <p>Signals from computer pin2 - Rx pin3 - Tx pin5 - GND</p> <p>BALANCE</p> <p>SHIELD</p> <p>Signals from balance pin2 - Rx pin3 - Tx pin5 - GND</p> <p style="text-align: center;">PT0108</p>	<p><i>Weighing instrument - computer cable (RS232)</i></p>
<p>PRINTER EPSON, CITIZEN DB25/M</p> <p>Signal from printer EPSON, CITIZEN GND - pin7 RXD - pin3 TXD - pin2</p> <p>BALANCE DB9/F</p> <p>Signal from balance pin5 - GND pin3 - Tx pin2 - Rx</p> <p style="text-align: center;">PT0151</p>	<p><i>Weighing instrument – printer cable (EPSON)</i></p>

1.4. Intended Use

PM series balances have been designed to enable precise determination of mass in laboratory.

1.5. Precautions

- Prior to the first use, carefully read this User Manual. Use the device only as intended.
- Do not operate the touch panel using sharp-edged tools (knife, screwdriver, etc.).
- Place weighed loads in the centre of the weighing pan.
- Load the weighing pan with loads of gross weight which does not exceed the maximum capacity.
- Mind not to leave heavy loads on the weighing pan for longer periods of time.
- In the case of damage, immediately unplug the device from the mains.
- Weighing instruments to be decommissioned must be decommissioned in accordance with valid legal regulations.
- Do not use the weighing instrument in areas endangered with explosion. The balance is not intended to be operated in EX zones.

1.6. Warranty Conditions

- A. RADWAG feels obliged to repair or exchange all elements that appear to be faulty by production or by construction.
- B. Defining defects of unclear origin and means of their elimination can only be realized with assistance of manufacturer and user representatives.
- C. RADWAG does not bear any responsibility for damage or losses resulting from unauthorized or inadequate performing of production or service processes.
- D. The warranty does not cover:
 - mechanical damage caused by product exploitation other than intended, damage of thermal and chemical origin, and damage caused by lightning, overvoltage in the power grid or other random event,
 - damage caused by product exploitation other than intended,
 - mechanical damage, if service claims removing or destroying protective stickers which secure the balance's housing against unauthorized access,
 - damage caused by liquids, water and natural wear,
 - damage caused by inappropriate setting or by electrical wiring failures,
 - damage caused by overloading of the mechanical measuring system,
 - inappropriate cleaning habits.
- E. Loss of warranty takes place if:
 - a repair is carried out outside RADWAG authorized service point,
 - service claims intrusion into mechanical or electronic construction by unauthorized people,
 - other than original version of the operating system is installed in a balance,
 - the indicator does not bear company protective stickers.
- F. For detailed warranty conditions read the warranty certificate.

1.7. Supervision Over Metrological Parameters

Metrological parameters need to be checked in determined time intervals. Inspection frequency depends on ambient conditions in which the weighing instrument is operated, kind of carried out processes and adopted quality management system.

1.8. User Manual Significance

Even if you are experienced and have already worked with this type of weighing instrument, you are still obliged to read this user manual carefully prior to switching the device on. This user manual provides necessary operation-related information. Following the user manual guidelines guarantees correct weighing instrument performance.

1.9. Balance Operator Training

The weighing instrument must be utilized and supervised only by persons who have been trained to operate such type of a weighing instrument.

2. TRANSPORT AND STORAGE

2.1. Delivery Check

Upon delivery it is necessary to check the package and the device, make sure that your package bears no signs of damage. Otherwise contact the manufacturer's representative.

2.2. Packaging

Keep all package elements should your device be transported in the future. Remember that only original packaging can be used for shipping purposes. Prior to packing, uncouple any cables, remove any separable components (weighing pan, shields, inserts). The device components shall be packed into an original packaging, thus being protected against potential damage during transportation.

3. UNPACKING AND INSTALLATION

3.1. Place of Use



- Operate the device in a workroom free of vibrations and shakes, where there are no air drafts nor dust.
- Make sure that the ambient temperature ranges between +10 °C ÷ +40 °C.
- Make sure that the relative humidity is not higher than 80%.
- Make sure that the temperature changes slowly in the course of operation.
- Place the weighing instrument either on a robust-design table or on a wall bracket, which is both distant from heat sources and insusceptible to vibrations.
- Take special precaution while weighing magnetic objects, as part of the balance is a strong magnet. Should such loads be weighed, use under-pan weighing option in order to remove the weighed load from an area influenced by the magnet. The hook for under-pan weighing is installed in the weighing instrument's base.

3.2. Standard Delivery Components List

- balance
- standard weighing pan, open-work weighing pan – *PM 10.C32 and PM 15.C32 models exclusively,*
- power supply,
- user manual - CD version.

3.3. Unpacking

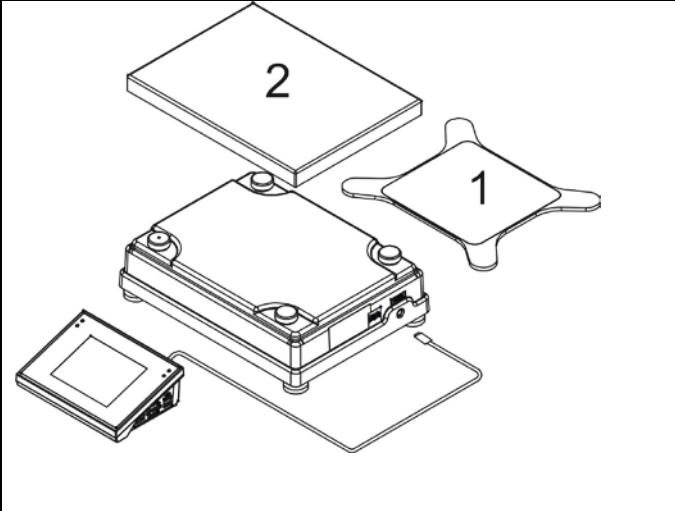
Cut the adhesive tape. Take the device out of the packaging. Open the accessory box, take the device components out of it. Put the weighing instrument in the place of use and install the weighing pan, follow the below procedure.

	<p>Install the weighing pan 1 for PM with $d=0.01g$ or pan 2 for other PM model .</p> <p>Make sure that the pan is installed properly on the pan receivers: it cannot touch the housing and must be stable.</p> <p>Connect the indicator first (the connector is to be found at the back of the balance housing), next connect the supplementary equipment.</p> <p>Now, connect the weighing instrument to the mains (the power supply socket is located on the left side of the indicator).</p>
	<p>CAUTION:</p> <p>When connecting the indicator to the weighing instrument make sure that flat side of the PS2 connector is directed upwards. Make sure the arrows on the connector are visible as presented in the figure.</p>

3.4. Levelling

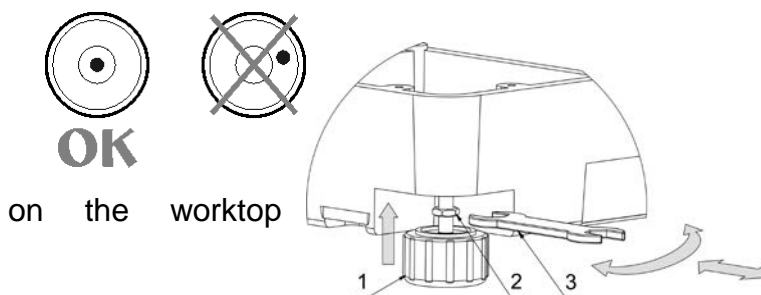

It is necessary to level the balance prior to connecting it to the mains. To level the balance turn its feet until the air bubble takes central position. Make sure that all balance feet rest surface firmly.

After adjusting the balance level, use wrench (3) in order to tighten bolt (2) of foot (1), the bolt must touch balance housing. Keep tightening the bolt until it resists. With this the foot

will not unscrew in the course of operation. See the figure on the left. Repeat this set of actions for the remaining balance feet.

3.5. Maintenance Activities

In order to clean the weighing instrument risk-free, proceed as follows:

1. Uninstall the weighing pan and other detachable components; (the components differ depending on a balance model, read section: *UNPACKING AND INSTALLATION*. Be careful while installing the components so as not to cause any damages to the balance mechanism.
2. It is possible to disassembly the anti-draft chamber in order to clean it properly - for disassembly instruction read below.

Caution:

Cleaning the weighing pan while still installed may cause damage of the measuring system.

Cleaning ABS Components

To clean dry surfaces and avoid smudging, use clean non-colouring cloths made of cellulose or cotton. You can use a solution of water and detergent (soap, dishwashing detergent, glass cleaner). Gently rub the cleaned surface and let it dry. Repeat the cleaning process if needed.

In the case of hard to remove contamination, e.g: residues of adhesive, rubber, resin, polyurethane foam etc., you can use a special cleaning agents based on a mixture of aliphatic hydrocarbons that do not dissolve plastics. Before using the cleanser for all surfaces we recommend carrying out tests. Do not use cleansers containing abrasive substances.

Cleaning Draft Shield Panes

Select dissolvent depending on a dirt. Never soak the glass panes in alkaline solutions since they interact with glass and may cause damage. Do not use cleansers containing abrasive substances.

For organic dirt use acetone first, next use water or detergent. For other than organic dirt use diluted acid solutions (soluble salts of hydrochloric or nitric acid) or base solutions (ammonium or sodium base).

To remove ACIDS use protophilic solvent (sodium carbonate), to remove BASE use protogenic solvent (mineral acid of various concentration).

In the case of heavy contamination use brush and detergent, nevertheless avoid detergents containing large and hard molecules which could potentially scratch glass panes.

At the end of the cleaning process rinse the pane using distilled water.

Use soft brush with wooden or plastic handle exclusively in order to avoid risk of scratches. Do not use wire brush.

Rinsing is a necessary cleaning process stage allowing to remove remaining soap, detergents and other cleansers from the panes prior to their reinstallation.

After preliminary cleaning process stage, rinse the pane using running water first, distilled next.

Avoid drying the panes either using paper towel or forced air circulation since some fibres, grains or contamination of other type could permeate into the panes thus causing weighing errors.

We do not recommend using driers when drying measuring glass tools.

It is a frequent treatment to leave glass components on a rack to dry.

Cleaning Stainless Steel Components

Avoid using cleansers containing any corrosive chemicals, e.g. bleach (including chlorine). Do not use cleansers containing abrasive substances. Always remove the dirt using microfibre cloth to avoid damage of protective coating.

In the case of a daily maintenance:

- 1. Remove the dirt using cloth dipped in warm water.*
- 2. For best results, add a little dishwashing detergent.*

Cleaning Powder-Coated Components

For preliminary cleaning process stage you need running water or wet sponge featuring large holes, this will help you to remove loose, heavy dirt.

Do not use cleansers containing abrasive substances.

Next, using cloth and cleanser-water solution (soap, dishwashing liquid) gently rub the cleaned surface.

Avoid using cleanser without water since it may result with damage of the cleaned surface, please mind that large amount of water mixed with cleanser is a must.

Cleaning Aluminium Components

While cleaning aluminium components use products acid by nature, e.g. spirit vinegar, lemon. Do not use cleansers containing abrasive substances. Avoid using hard brush, this may cause scratches. It is recommended to use microfibre cloth.

While polishing the surface use circular movements. Use clean, dry cloth to make the surface shine.

3.6. Connecting the Weighing Instrument to the Mains

The weighing instrument can be connected to the mains only with a power supply that comes standard with a particular model. Nominal voltage of the power supply (specified on the power supply data plate) has to be compatible with the power from the mains.

Plug the balance to the mains, i.e. connect the power supply to the socket first, next connect its connector to a port located on the left side of the indicator.

After connecting the balance to the mains, RADWAG logo is displayed. Next you shall see the home screen and ZERO indication with a respective reading unit (the reading unit depends on the balance model). During the balance start, the test of an internal adjustment mechanism takes place (the internal adjustment weight is put down and lifted up). If the indication is different than zero, press  key.

Caution:

Before switching the balance off and on again (i.e. before connecting and disconnecting the power supply) it is necessary to wait 10 seconds.

3.7. Temperature Stabilization Time

Before start of the measuring processes, it is necessary to wait until the balance reaches thermal stabilisation.

Balances stored in much lower temperatures, than the workroom temperature, before being plugged to the mains (e.g. during winter period) must be subjected to thermal stabilisation. The thermal stabilisation period takes about 8 hours. During the thermal stabilization, the indications on the screen can change. Potential workroom temperature change shall occur gradually and slowly in the course of the weighing instrument operation.

3.8. Connecting Additional Hardware

Use only accessories and peripheral equipment recommended by the manufacturer. The balance must be disconnected from the mains before connecting or disconnecting any peripherals (printer, PC, computer keyboard of USB type, additional display). Upon connecting the peripherals, plug the balance to the mains.

4. START-UP



- Connect the power supply to the mains. Plug it to the power supply socket.
- The balance activates automatically, if not, press  key , it is to be found on the top of the operation panel.
- Upon completed start-up, the home screen is displayed automatically.
- The balance runs with no user logged in. In order to start operation it is necessary to carry out the logging procedure (for detailed logging procedure read later sections of this user manual).



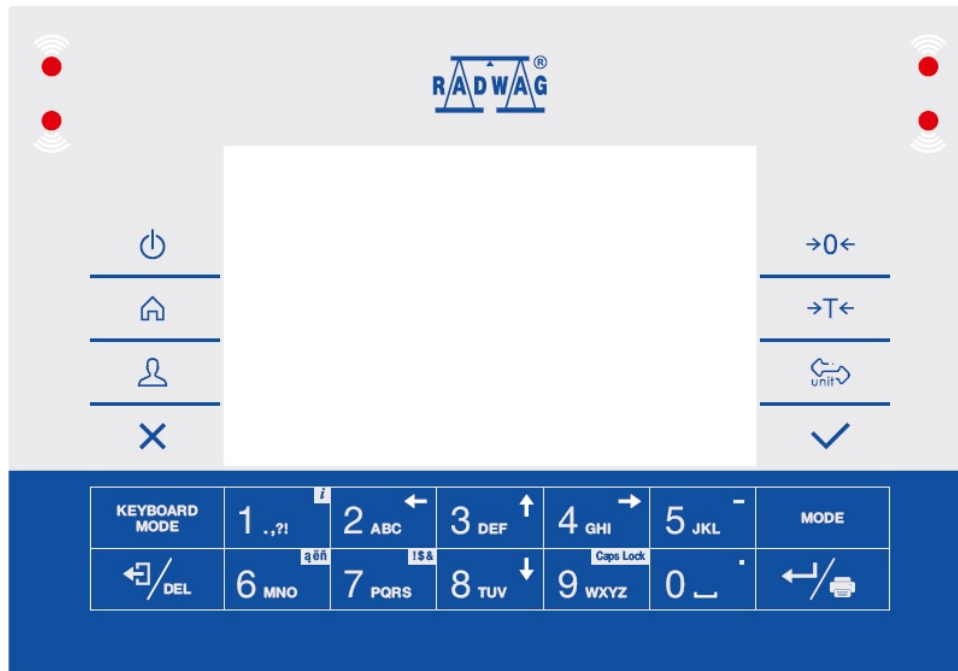









Caution: Before you start the balance, make sure that there is no load on the weighing pan. In accordance with the EN 45515 standard verified balances cannot display mass value below $-20e$. If the indication value is below $-20e$, <Lo mass> information is displayed. Press  key to zero the balance.

5. OPERATION PANEL

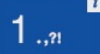

Keys:

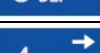
	Press to switch the display on/off. Upon switching the display off, the other subassemblies remain powered and the weighing instrument is ready for operation.
	Press to enter the main menu.

	Press to log in.
	Press to cancel the message.
	Press to zero the balance.
	Press to tare the balance.
	Press to change the weighing unit.
	Press to confirm the message.
	Press to confirm the weighing result (PRINT). Press to confirm the message (ENTER).
	Press to cancel the messages.
	Press to change the working mode.
	Programmable key assigned to an on-screen button i key – press it for a longer period of time to get balance info.
	Programmable key assigned to a screen button.
	Programmable key assigned to a screen button.
	Programmable key assigned to a screen button.
	Programmable key assigned to a screen button.

6. HOME SCREEN

The home screen features 4 sections:

- top bar,
- weighing result window,
- workspace,
- pictograms.



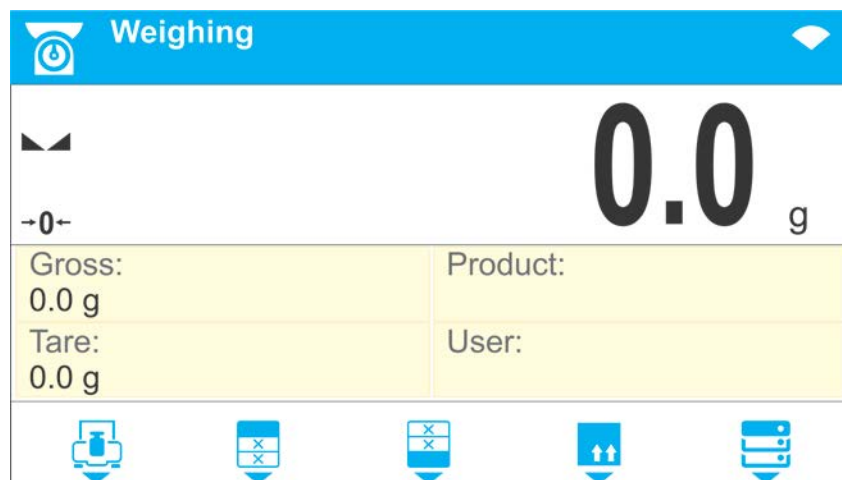



Home screen view:



6.1. Top Bar



The top bar displays the following information:

 Weighing	Working mode name and symbol.
	Symbol informing that wireless communication is on.
	Symbol informing that communication with a USB flash drive is on.
	Symbol informing that PC keyboard is connected.
	Symbol informing that printer is connected.
	Symbol informing that communication with a PC is on.

6.2. Weighing Result Window

Weighing result window provides all weighing-related data.

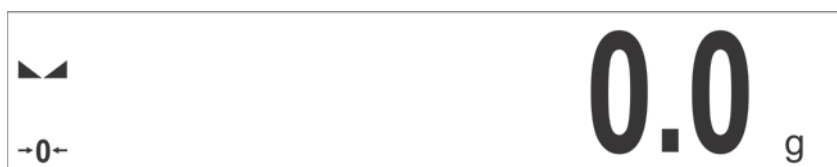

6.3. Workspace

The workspace is to be found underneath the weighing result window.

Gross: 0.0 g	Product:
Tare: 0.0 g	User:

The workspace comprises 4 programmable widgets. Each working mode features default home screen widgets set. You can customize the screen. For detailed information concerning the workspace read section 'Display'.

6.4. Pictograms

The pictograms assigned to operation panel keys are to be found underneath the workspace.



You can define screen pictograms individually for each working mode. For detailed procedure informing you how to define screen pictograms read section 'Display'.

7. OPERATING THE MENU

In order to navigate the program menu, use the operation panel.







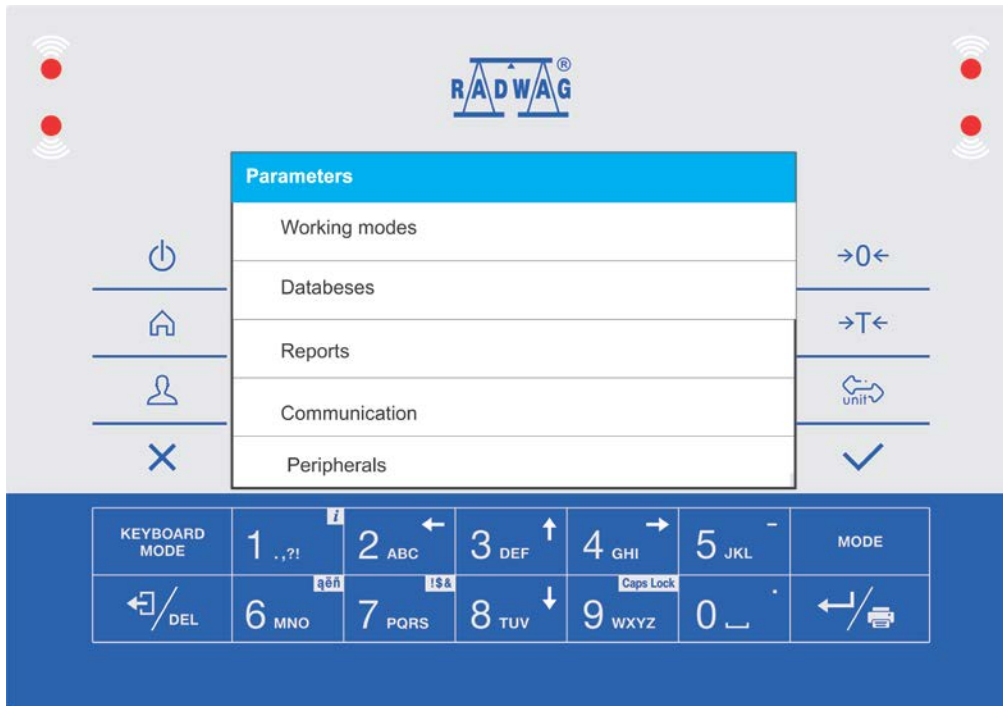

7.1. Entering the Menu

In order to enter the menu press  key of the operation panel. Background colour of the first menu position differs from the remaining ones. To navigate the program menu use the keys that operate as arrow keys.

Menu view

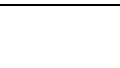

7.2. Menu Keys

	Press to enter the main menu. Press to go to home screen.
	Press to move one menu level up, or to discard entering parameter modifications.
	Press to move one menu level up. Press to delete a character when editing numeric and text values.
	Press to change keyboard mode when editing numeric and text values.
	Press to select/change working mode.
	Press to confirm/accept modifications.
	Press to move one menu level up, or to discard entering parameter modifications.
	Press to select higher-level parameters group, or to edit parameter value and change it by one digit up.
	Press to select parameters group that you want to operate. The first parameter of the selected parameters group is displayed.
	Press to select lower-level parameters group, or to edit parameter value and change it by one digit down.

7.3. Entering Numeric and Text Characters and Signs

Depending on a type of data entered to balance memory the software offers two different edit boxes:

- numerical box (for entering part mass values, tare values, etc.).
- text box (for entering printout template, universal variable value, etc.).

Button functions change depending on the edit box type.

7.3.1. Numerical Box

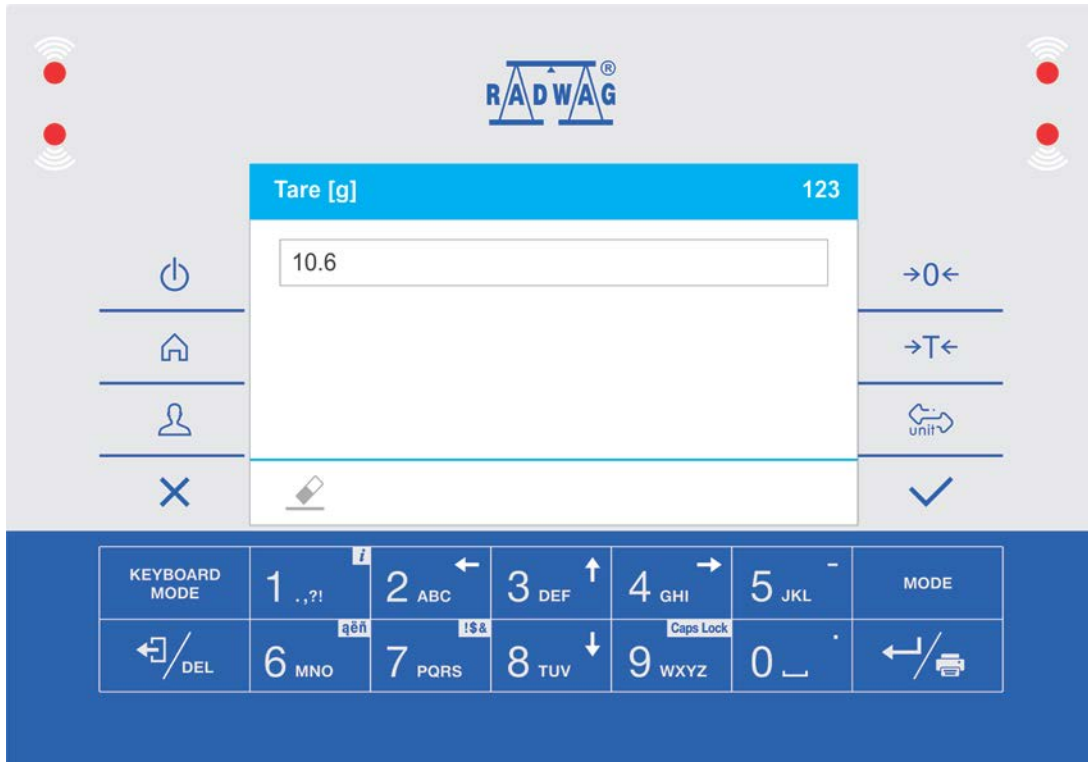









Where:

123	Digits mode. To change keyboard working mode press KEYBOARD MODE key. Keyboard working mode options: 123 - digits mode, ↕ - arrow keys operation, Fn - bottom line operation.
	Press to clear box content.

Keys:







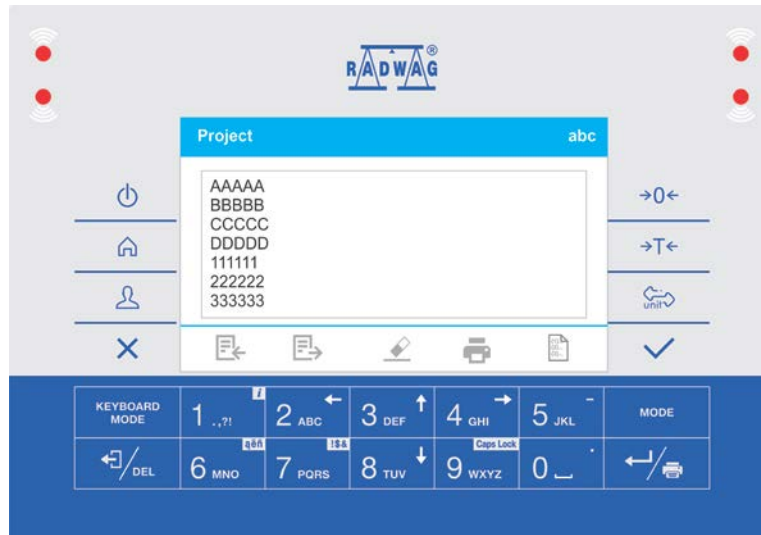





1 .,?!	Press to enter digit 1.
2 ABC	Press to enter digit 2.
3 DEF	Press to enter digit 3.
4 GHI	Press to enter digit 4.
5 JKL -	Press to enter digit 5. Press to enter „-” (minus) sign, hold the key for a few seconds.

	Press to enter digit 6 .
	Press to enter digit 7 .
	Press to enter digit 8 .
	Press to enter digit 9 .
	Press to enter digit 0 . Press to enter „.” (dot) sign, hold the key for a few seconds.
	Press to delete one character.
	Press to exit, the box remains unmodified.
	Press to confirm the modifications.
	Press to change keyboard working mode.

7.3.2. Text Box



Where:

	Capital letters mode. To change keyboard working mode press  key. Keyboard working mode options:  - upper-case characters mode,  - lower-case characters mode,  - digits mode,  - arrow keys operation,  - bottom line operation.
	Press to save project to *.lb file on USB flash drive.
	Press to read project saved to *.lb file on USB flash drive.
	Press to clear box content.
	Press to print project using printer connected to the indicator.
	Press to view list of variables that can be used in the project.

Keys:

	Press to enter . , { } : ° - .
	Press to enter a b c . Press to move the cursor to the left, hold the key for a few seconds.
	Press to enter d e f . Press to move the cursor up, hold the key for a few seconds.
	Press to enter g h i . Press to move the cursor to the right, hold the key for a few seconds.
	Press to enter j k l . Press to enter „ - ” sign, hold the key for a few seconds.
	Press to enter m n o . Press to activate „ aññ ” function (diacritical signs table).
	Press to enter p q r s . Press to activate „ !\$& ” function (special signs table).
	Press to enter t u v . Press to move the cursor down, hold the key for a few seconds.
	Press to enter w x y z . Press to activate „ Caps Lock ” function.
	Press to enter ␣ (space) sign. Press to enter „ . ” sign, hold the key for a few seconds.”.
	Press to go to the next line in the editing box.
	Press to delete one character.
	Press to exit, the box remains unmodified.
	Press to confirm the modifications.
	Press to change keyboard working mode.

7.3.3. Diacritical Signs Table

In order to activate diacritical signs table while editing text box it is necessary to press and hold key. Diacritical signs characteristic for a particular interface language are automatically added to the table when the given language gets selected.

Diacritical signs table: Polish.										Diacritical signs table: English, German, French, Spanish.											
ą	ć	ę	ł	ń	ó	ś	ź	ż	á	č	ä	ö	ü	à	â	æ	œ	ç	è	é	ê
đ	é	ě	í	ñ	ř	š	ú	ů	ý	ž	ë	î	ï	ô	ù	û	ü	ÿ	ñ	á	ã
â	ă	ă	í	î	đ	ô	ô	ö	ř	ş	â	ì	í	ð	ò	ó	õ	ú	ý	þ	š
		ú	ü	ł	ł	â	ø	æ					ž	ğ	ş	ø	ı	ß			

Where:

	Press to activate „ Caps Lock ” function.
	Press to switch to special signs keyboard.

7.3.4. Special Signs Table

In order to activate special signs table while editing text box it is necessary to press and hold  key.



,	.	?	'	!	"	-	()	@	/
:	_	;	+	&	%	*	=	<	>	£
€	§	¥	°	[]	{	}	\	~	^
	aññ	#	\$		μ	β	©	®	™	`

Where:

	Inactive
aññ	Press to switch to diacritical signs keyboard.

7.4. Return to the Weighing Mode

Any changes made in balance's memory are automatically saved upon returning to the home screen. To return to the home screen:

- press  key repeatedly, keep pressing the key until you see the home screen,
- press  key, the home screen is displayed immediately.

8. DISPLAY

You can customize the home screen and the displayed data. Customization concerns the workspace (fields 1, 2, 3, 4) and the bottom area (5) featuring programmable buttons with functions assigned to numeric keys of the operation panel:



In order to customize the screen go to  /Display> submenu.

8.1. Workspace

Workspace of your weighing device can comprise the following widgets: label, text box, bar graph. Each working mode features default home screen widgets set.

Available fields (**widgets**) dimensions (width x height):

- Label – 1x1; 2x1.
- Text box - 1x1; 2x1.
- Bar graph – 1x1; 2x1.

2x1 field size equals size of two 1x1 fields (1 and 2 or 3 and 4). The program automatically detects suitable widget size matching particular area. The widgets are displayed in declared fields after completing data setup and leaving 'Settings' menu.













8.1.1. Label

Field displaying information updated in a real time in the course of weighing device operation (selected product name, gross weight value, etc.).

<Workspace components> submenu for a field comprising <Label> widget features the following options:

Information	Enter this parameter to read info on selected widget type and dimensions.
Settings	Enter this parameter to specify which widget-assigned data is to be displayed.
Delete	Enter this parameter to delete the widget. Upon entering, a respective warning is displayed: <Delete?>. Press  key for confirmation.
Add	Option available only for those widgets that have not been added yet. Upon entering <Add> submenu you can select <Label> widget of particular dimensions.

Label data list (data accessibility is conditioned by a working mode).

Label	Working mode											
												
Date	✓	✓	✓	✓	✓	✓	✓	✓	✓	✓	✓	✓
Time	✓	✓	✓	✓	✓	✓	✓	✓	✓	✓	✓	✓
Date and time	✓	✓	✓	✓	✓	✓	✓	✓	✓	✓	✓	✓
Net	✓	✓	✓	✓	✓	✓	✓	✓	✓	✓	✓	✓
Tare	✓	✓	✓	✓	✓	✓	✓	✓	✓	✓	✓	✓
Gross	✓	✓	✓	✓	✓	✓	✓	✓	✓	✓	✓	✓
Last recorded measurement	✓	✓	✓	✓	✓	✓	✓	✓	✓	✓	✓	✓
Operator	✓	✓	✓	✓	✓	✓	✓	✓	✓	✓	✓	✓
Product	✓	✓	✓	✓	✓	✓	✓	✓	✓	✓	✓	✓
Packaging	✓	✓	✓	✓	✓	✓	✓	✓	✓	✓	✓	✓
Customer	✓	✓	✓	✓	✓	✓	✓	✓	✓	✓	✓	✓
Variable 1	✓	✓	✓	✓	✓	✓	✓	✓	✓	✓	✓	✓
Variable 2	✓	✓	✓	✓	✓	✓	✓	✓	✓	✓	✓	✓
Variable 3	✓	✓	✓	✓	✓	✓	✓	✓	✓	✓	✓	✓
MSW value	✓	✓	✓	✓	✓	✓	✓	✓	✓	✓	✓	✓
MSW tare	✓	✓	✓	✓	✓	✓	✓	✓	✓	✓	✓	✓
MSW status	✓	✓	✓	✓	✓	✓	✓	✓	✓	✓	✓	✓
Bar graph			✓	✓							✓	
Part mass		✓										
Thresholds			✓									
MIN threshold			✓									
MAX threshold			✓									
Target value				✓							✓	
Reference mass					✓							
Weighing in air						✓	✓					
Weighing in liquid						✓	✓					
Liquid						✓						
Temperature						✓						

Liquid density						✓						
Sinker volume							✓					
Number									✓			✓
Sum									✓		✓	✓
Average									✓			
Min									✓			
Max									✓			
Difference									✓			
SDV									✓			
RDV									✓			
Threshold										✓		
Formulation											✓	

✓ - Default label settings

8.1.2. Text Box

Field displaying weighing-related information. As an operator you can freely program the field content (texts and variables of line 1 and line 2).

Caution:

1. For detailed description of text editor read section 'Operating the Menu'.
2. For list of available variables refer to section 'Printouts'.

<Workspace components> submenu for a field comprising <Text box> widget features the following parameters:

Information	Enter this parameter to read info on selected widget type and dimensions.
Settings	Enter this parameter to specify which widget-assigned data is to be displayed. Upon entering this parameter line 1 and line 2 settings are displayed. Lines 1, 2 can comprise 45 characters maximum.
Delete	Enter this parameter to delete the widget. Upon entering, a respective warning is displayed: <Delete?>. Press  key for confirmation.
Add	Option available only for those widgets that have not been added yet. Upon entering <Add> submenu you can select <Text field> widget of particular dimensions.

8.1.3. Bar Graph

Bar graph is available for all working modes. It is a graphic visualisation informing you how much of the weighing device capacity is used. It allows you to observe whether the load stays within the specified Max capacity or is out of it. Additionally it shows Min and Max thresholds positions for Checkweighing mode, and for Dosing mode it shows target weight value along with permissible tolerance.

<Workspace components> submenu for a field comprising <Bar graph> widget features the following parameters:

Information	Enter this parameter to read info on selected widget type and dimensions.
Settings	This submenu allows you to choose between two functions: 1. Bar graph type : Linear presentation of the weighing range 2. Zoom : Enabling/disabling bar graph zoom in order to provide more clear visualisation of the Min threshold - Max threshold range.
Delete	Enter this parameter to delete the widget. Upon entering, a respective warning is displayed: <Delete?> . Press  key for confirmation.
Add	Option available only for those widgets that have not been added yet. Upon entering <Add> submenu you can select <Bar graph> widget of particular dimensions.

Bar graph operation:

Basic bar graph provides you with linear presentation of the weighing range.



CHECKWEIGHING mode bar graph

- Visualisation of mass value lower than MIN value:

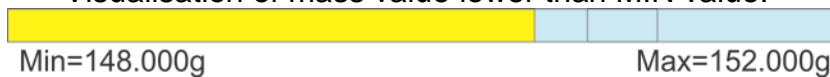

- Visualisation of mass value higher than MIN value and lower than MAX value:



- Visualisation of mass value higher than MIN value and lower than MAX value, **<Zoom>** option on:



Visualisation of mass value higher than MAX value:

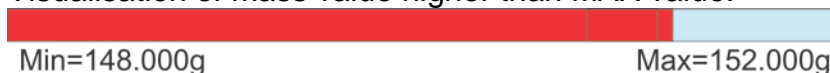

DOSING mode bar graph

- Visualisation of mass value lower than target value - 10% (below 135g):



- Visualisation of mass value higher than MIN value and lower than MAX value:



- Visualisation of mass value higher than MIN value and lower than MAX value, **<Zoom>** option on:



Visualisation of mass value higher than set target value + 10% (above 165g):



8.2. Keys

















Programmable numeric keys (0 - 9). These are so called quick access keys for triggering the most often performed operations. Numeric keys 1 - 5 are additionally provided with graphic symbol which you can see in the bottom bar of the display.

Procedure:

- Enter **<Display/Buttons functions>** submenu, edit a respective key,
- Select the function you want to assign to the key, next go back to the home screen.

Keys functions list (function accessibility is conditioned by a working mode).

Pictogram	Function	Working mode											
	Accept/Print	✓	✓	✓	✓	✓	✓	✓	✓	✓	✓	✓	✓
	Print header	✓	✓	✓	✓	✓	✓	✓	✓	✓	✓	✓	✓
	Print footer	✓	✓	✓	✓	✓	✓	✓	✓	✓	✓	✓	✓
	Zero	✓	✓	✓	✓	✓	✓	✓	✓	✓	✓	✓	✓
	Tare	✓	✓	✓	✓	✓	✓	✓	✓	✓	✓	✓	✓
	Set tare	✓	✓	✓	✓	✓	✓	✓	✓	✓	✓	✓	✓
	Change unit	✓		✓	✓		✓	✓	✓	✓	✓	✓	✓
	Select unit	✓		✓	✓		✓	✓	✓	✓	✓	✓	✓
	Parameters	✓	✓	✓	✓	✓	✓	✓	✓	✓	✓	✓	✓
	Databases	✓	✓	✓	✓	✓	✓	✓	✓	✓	✓	✓	✓
	Select operator	✓	✓	✓	✓	✓	✓	✓	✓	✓	✓	✓	✓
	Select product	✓	✓	✓	✓	✓	✓	✓	✓	✓	✓	✓	✓
	Select customer	✓	✓	✓	✓	✓	✓	✓	✓	✓	✓	✓	✓
	Select packaging	✓	✓	✓	✓	✓	✓	✓	✓	✓	✓	✓	✓
	Adjustment	✓	✓	✓	✓	✓	✓	✓	✓	✓	✓	✓	✓
	Edit universal variable 1	✓	✓	✓	✓	✓	✓	✓	✓	✓	✓	✓	✓
	Edit universal variable 2	✓	✓	✓	✓	✓	✓	✓	✓	✓	✓	✓	✓
	Edit universal variable 3	✓	✓	✓	✓	✓	✓	✓	✓	✓	✓	✓	✓
	Last digit	✓	✓	✓	✓	✓	✓	✓	✓	✓	✓	✓	✓
	Reports	✓	✓	✓	✓	✓	✓	✓	✓	✓	✓	✓	✓
	Set time	✓	✓	✓	✓	✓	✓	✓	✓	✓	✓	✓	✓
	Set date	✓	✓	✓	✓	✓	✓	✓	✓	✓	✓	✓	✓
	Set part mass		✓										

	Determine part mass		✓										
	Reference sample quantity - 5 pcs.		✓										
	Reference sample quantity – 10 pcs.		✓										
	Reference sample quantity – 20 pcs.		✓										
	Reference sample quantity – 50 pcs.		✓										
	Reference sample quantity – 100 pcs.		✓										
	Set checkweighing thresholds			✓									
	Set MIN threshold			✓									
	Set MAX threshold			✓									
	Set target mass				✓								
	Set reference mass					✓							
	Determine reference mass					✓							
	Start procedure						✓	✓	✓			✓	
	Display statistics result									✓			
	Finish statistics									✓			
	Finish										✓		
	Select formulation											✓	
	Display adding result												✓
	Working mode parameters	✓	✓	✓	✓	✓	✓	✓	✓	✓	✓	✓	✓
	Profile	✓	✓	✓	✓	✓	✓	✓	✓	✓	✓	✓	✓
	None	✓	✓	✓	✓	✓	✓	✓	✓	✓	✓	✓	✓

✓ - Default keys settings

8.3. Default Screen Settings

Function allowing you to set default workspace values and default function keys for a particular working mode.

Procedure:

- Enter **<Display/Default screen settings>** submenu, a respective warning is displayed: **<Continue?>**.
- Press  key for confirmation.
- Default workspace values and default function keys for a particular working mode are set. Next, **<Display>** submenu is shown automatically.

9. OUTPUTS / INPUTS

C32 series scale is equipped with 4 inputs and 4 outputs by standard.

In order to set inputs and outputs enter: **<**  **> / Inputs/Outputs>** submenu.

9.1. Input Setup

- Enter **<Inputs / Outputs>** submenu.
- Select **<Inputs>** parameter and edit respective input, list of functions that can be assigned to the input is displayed. Input function list is identical like key function list, read **'Key Functions'** section. Function list is conditioned by a working mode.
- Select the function you want to assign to the input, next go back to the home screen.

Caution: By default all functions are assigned with **<None>** value.

9.2. Output Setup

Output gets activated at the moment of assigning it with a given function. Unassigned outputs remain inactive.

Procedure:

- Enter **<Inputs / Outputs>** submenu.
- Select **<Outputs>** parameter and edit respective output, list of functions that can be assigned to the output is displayed.

None	Output inactive.
Stable	Stable weighing result over LO threshold value.
MIN stable	Stable weighing result below MIN threshold.
MIN unstable	Unstable weighing result below MIN threshold.
OK stable	Stable weighing result between MIN and MAX thresholds.
OK unstable	Unstable weighing result between MIN and MAX thresholds.
MAX stable	Stable weighing result over MAX threshold.
MAX unstable	Unstable weighing result over MAX threshold.
Zero	Zero weighing result („zero” marker).
! OK unstable	Unstable weighing result out of OK threshold.
! OK stable	Stable weighing result out of OK threshold.
MIN	MIN threshold signalling.
OK	OK threshold signalling.
MAX	MAX threshold signalling.
Active process	Ongoing process signalling.

- Select the function you want to assign to the output, next go back to the home screen.

Caution: By default all functions are assigned with **<None>** value.

10. PROGRAM

Program menu is divided into function groups. Function group is a group of interrelated parameters.

Function Groups:

- Working modes,
- Databases,
- Reports,
- Communication,
- Peripherals,
- Printouts,
- Display,
- Permissions,
- Units,
- Adjustment,
- Ambient conditions
- Misc,
- Balance data,
- Import / Export (visible upon plugging USB flash drive to the USB port)



11. LOG IN OPERATION

In order to access operator-related parameters and in order to edit databases, you need to log in as an operator with **<Administrator>** permissions levels.

Caution:

<Admin> is a default operator set on each brand new balance. The default operator is assigned with **<Administrator>** permissions levels. **<Admin>** account is protected by password: **1111**. Log in operation of default operator is carried out **automatically** upon balance start-up. In the case of modification of default operator data or upon adding new operators, it is necessary to log in **manually**.

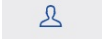
First Log In operation:

- Go to home screen, press  key, wait for the operators database to open.
- Select **<Admin>** operator, wait for the on-screen keyboard with a password box to open.
- Enter „1111” password and press  key to confirm.
- The home screen is displayed.
- When logged, add operators and set the permissions levels, *for detailed procedure read section: 28*).

While Logging In again, select an operator from the list and enter the password, the software initiates operation with permissions level set for the selected operator.

Log Out operation:

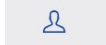
- Go to home screen, press  key, wait for the operators database to open.
- Select **<Log out>** option (*1st position on the operators list*).

- The home screen is displayed.

Permissions Levels

There are 4 permissions levels: Administrator, Advanced Operator, Operator, None.



Access to operator-related parameters, databases and program functions is conditioned by permissions level:

<i>Permissions level</i>	<i>Available parameters and functions</i>
None	Permission to edit operator-related parameters not granted. Operator can neither accept the weighing result nor start the following operations: entering reference sample mass and determining reference sample quantity in working mode <Parts counting>, entering reference sample mass and determining reference sample in working mode <Percent weighing>.
Operator	Operator can edit parameters of <Readout/Filter> submenu, set parameters of <Misc> submenu (except for <Date and time>, <Permissions>, <Software update> parameters). Operator can run and carry out all weighing operations. Operator can preview <Databases> data, and define universal variables.
Advanced operator	Operator can edit the following submenus: <Readout>; <Working modes>; <Communication>; <Peripherals>; <Misc> (operation of <Date and time>, <Permissions> and <Software update> parameter excluded). Operator can run and carry out all weighing operations.
Administrator	Operator can edit all operator-related parameters and all databases, and use all functions.

12. WEIGHING OPERATION

Load the weighing pan. Read the result when  stability marker is displayed .

In order to record/print the weighing result press  key:

- for verified weighing instruments – only stable weighing result is recorded or printed (stability marker  displayed),
- for non-verified weighing instruments – stable or unstable weighing result is recorded or printed (stability marker  not displayed); Unstable weighing result is marked with <?> on the printout, the question mark is printed next to the weight value.

12.1. Good Weighing Practice

To assure long-term operation and correct mass measurements, follow the rules presented below:

- Start the balance with no load on the weighing pan (permissible value of load on the weighing pan at start is $\pm 10\%$ of the maximum capacity).

- Load the weighing pan steadily avoiding shocks:

YES

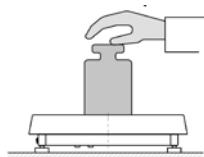

NO

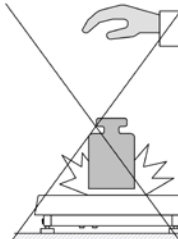

- Place weighed loads centrally on the weighing pan:

YES

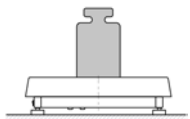

NO

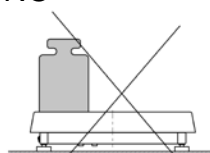

- Avoid side loading, in particular side shocks:

NO

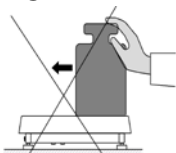

NO

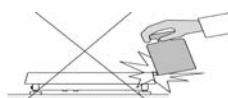

Prior to weighing or in the case of ambient condition changes, it is necessary to carry out balance adjustment.



- Prior to the measurement, it is recommended to load the weighing pan, several times, with mass close to the maximum capacity.
- Make sure that the unloaded weighing instrument indicates zero ('0' pictogram) and check whether the measurement is stable (▲ pictogram); if not, press **-0-/Delete** key.
- Press **UNITS** key to set the unit.

Do not unplug the balance from the mains between measurement series. It is recommended to disable the display, do it by pressing **ON/OFF** key. Press **ON/OFF** key again, the balance is ready to carry out next measurements.

12.2. Units

UNITS parameter group enables you to specify which mass units are to be available in the course of operation, and to define two custom units. These two options improve both comfort and speed of work. You can change unit [g] to some other unit during the weighing process or during operation of other modes. 'Parts counting' and 'Percent weighing' modes are exceptions.



12.3. Weighing Unit Selection





In order to change the weighing unit either press the weighing unit pictogram displayed next to the weighing result value or click  key (if provided in the information box). Clicking the unit triggers its change, the clicked unit gets replaced with the unit that is next on the list of available units. Another method for unit change is selecting a particular unit out of the units list, to view the list click  key (if provided in the information box).
Units list:

unit	symbol	verified balance	unit	symbol	verified balance
gram	[g]	yes	Tael Taiwan	[tlt]	no
milligram	[mg]	yes*	Tael China	[tlc]	no
kilogram	[kg]	yes*	Momme	[mom]	no
carat	[ct]	yes*	Grain	[gr]	no
pound	[lb]	no	Newton	[N]	no
ounce	[oz]	no	Tical	[ti]	no
ounce troy	[ozt]	no	baht	[baht]	no
pennyweight	[dwt]	no	tola	[tola]	no
Tael Hong Kong	[tlh]	no	mesghal	[msg]	no
Tael Singapore	[tls]	no			

* - units accessibility is conditioned by the weighing instrument type.

12.4. Weighing Units Accessibility

You can declare which units are to be accessible upon pressing  key. Units with parameter value set to <Yes  > option are available for selection in particular working modes, i.e. modes facilitating units change.

Availability	
g	
mg	
ct	
lb	
oz	

Units with parameter value set to <No  > option will not be accessible in the course of the weighing instrument operation.

12.5. Start Unit Selection

Upon setting start unit, the balance activates with the set start unit for these modes where change of the unit is possible.

Accessibility of particular units is conditioned by the weighing instrument status; i.e. on the fact whether the given balance is verified or not.

Units		Start unit
Availability	>	g
Start unit	g	mg
Acceleration of gravity	9.80665	ct
Custom unit 1	>	lb
Custom unit 2	>	

12.6. Gravitational Acceleration

<Gravitational acceleration> parameter compensates changes of gravity force being a result of different latitude and altitude when the selected unit is „Newton” [N].

Procedure:

- Enter **<Units/Gravitational acceleration>** submenu, **<Gravitational acceleration>** edit box is displayed.
- Enter gravitational acceleration value respective for the particular place of use and press  key to confirm changes.



12.7. Custom Units

Parameter allowing you to declare two custom units. Displayed custom unit value is a result of calculation, where obtained in the course of measurement weight value is multiplied by a multiplier determined for this particular custom unit. The custom units can be freely named with use of 3 characters maximum. By default the custom units are marked as: **[u1]** – custom unit 1 and **[u2]** – custom unit 2.

Units	
Availability	
Start unit	
Acceleration of gravity	
Custom unit 1	
Custom unit 2	

Custom unit 1	
Name	u1
Multiplier	1.0000

12.8. Zeroing Operation



To zero mass indication press  key. Zero indication and the following pictograms are displayed: **→0←** and .

Zeroing operation means determining new zero point, recognized by the weighing device as precise zero. The instrument can be zeroed only when the indication is stable.

Caution:

Indication can be zeroed only within $\pm 2\%$ range of maximum capacity. If the zeroed value is above $\pm 2\%$ of the maximum capacity, then the software displays a respective error message:



12.9. Taring Operation

To determine net weight value, load the weighing pan with a packaging, wait for a stable indication and press  key. Zero indication and the following pictograms are displayed: **Net** and . Upon unloading the weighing pan, the sum of tared masses with minus sign is displayed. You can assign tare value to a particular product stored in the database. In such case the assigned tare value is automatically acquired upon selection of the given product.

Caution: *It is impossible to tare negative values. When you try to tare negative values, the weighing instrument responds with an error message. In such case, zero the indication and repeat taring procedure.*

Entering tare value manually

Procedure:

- Press quick access key - . The key is available regardless of the working mode you operate.
- An on-screen numeric keyboard is displayed.
- Enter the tare value and press  key.
- Balance returns to the weighing mode. The entered tare value with '-' sign is displayed. <Net> marker appears in the upper-left corner of the screen.

Deleting tare

The tare value indicated on the display can be deleted by pressing  key located on the operation panel. Before you do it make sure that the weighing pan is empty.

Procedure 1 - upon taking the tared load off the weighing pan:



- Press  key.
- the <Net> marker gets deleted, new zero point is determined.

Procedure 2 - with tared load resting on the weighing pan:

- Press  key.
- the <Net> marker gets deleted, new zero point is determined.
- When the zeroed value is above 2% of the maximum capacity, then the software displays a respective error message.

Selecting tare value out of PACKAGING DATABASE

Procedure:

- Press  key located on the operation panel.
- Wait for a respective window to open, next press  button (PACKAGING).
- Window with a list of tare values recorded into packaging database opens.
- Select the packaging that is to be used.
- Balance returns to the weighing mode. The selected tare value (taken from the selected packaging record) with '-' sign is displayed. <Net> marker appears in the upper-left corner of the screen.

or

- Press  button (if provided on the display).
- Window with a list of tare values recorded into packaging database opens.
- Select the packaging that is to be used.
- Balance returns to the weighing mode. The selected tare value (taken from the selected packaging record) with '-' sign is displayed. <Net> marker appears in the upper-left corner of the screen.

AUTOTARE

Autotare function provides automatic taring of the packaging during the weighing process when packaging mass for each of the product is different. For detailed description of Autotare function operation, read later section of this user manual.

Deleting tare

The entered tare value can be deleted by pressing  key located on the operation panel, or by entering value of 0.00g (read the above description).

12.10. Weighing Profile

In order to make operation with the balance easier, 4 various profiles have been designed. Parameters for these profiles have been set (and saved) in a way ensuring that the weighings are carried out optimally for particular requirements and conditions.

Profile parameters concern settings of a given working mode, they are grouped in parameter: *Setup/Working modes/Weighing/Readout*.

For detailed description of Profile settings read the next section of this user manual.

Profile types:

- **User** – basic profile, filters settings provide quite fast and precise measurement.
- **Fast** – profile set to enable fast measurement of mass of any size regardless of the selected working mode. Fast profile gets activated automatically at the first balance start-up. For Fast profile, the parameters settings enable obtaining the final result as fast as possible.
- **Fast dosing** – profile intended for dosing, it is set to enable fast dispensing of product.
- **Precision** – profile set to enable precise measurement of mass of any size regardless of the selected working mode. For Precision profile the weighing process takes a lot of time, but this guarantees the most precise weighing result.

Caution: as an operator you can modify all profile settings only for User profile, when it comes to the remaining default profiles (Fast, Fast dosing and Precision) they can only be modified partially.

At the top of the screen a respective pictogram (letter) is displayed, it informs which profile is currently operated. The profile can be selected separately for a given working mode. The most recently used profile is remembered for each working mode (along with all introduced modifications), the mode, when activated, is run with the most recently used profile.

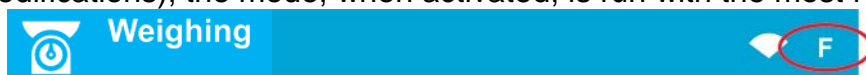

Profiles pictograms:

No.	Pictogram	Description
1	U	User profile
2	F	Fast profile
3	D	Fast dosing profile
4	P	Precision profile

Profile selection procedure:

- Press  key.

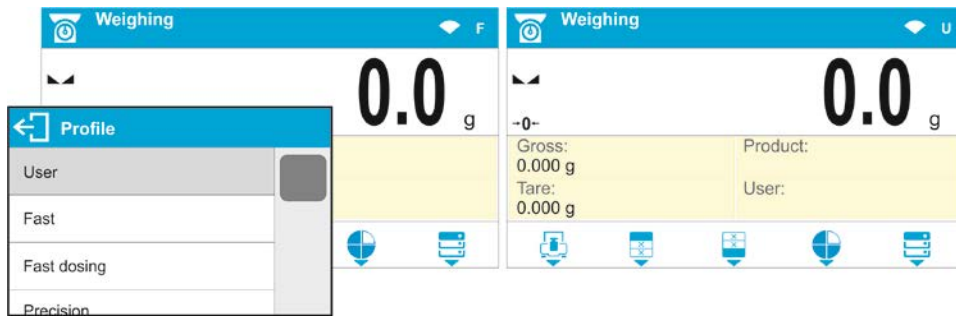

- List of profiles is displayed.
- Select demanded profile (grey background), to do it press either **8 TUV ↓** or **3 DEF ↑** button.
- Press **←/⏪** key to confirm.

12.11. WEIGHING Mode Settings- Readout

The software allows setup of operating parameters (filters, value release and autozero function, deleting the last digit and other settings) separately for each working mode. As an operator you can modify all profile settings only for **User** profile, when it comes to the remaining default profiles (**Fast, Fast dosing, Precision**) they can only be modified partially, i.e. you are not allowed to change **Filter and Value release** parameters for these profiles, the said parameters are set to default factory values.

It enables customizing the instrument and utilizing its properties depending on your needs and expectations, or on specific requirements for selected working mode (e.g. DOSING); as a result the device operation is quick and easy.

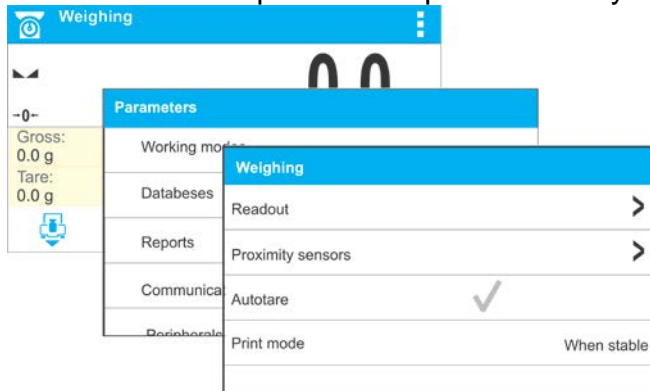

Setting filter level (option disabled for the following profiles: Fast, Fast dosing, Precision)

Weighing	
Readout	Readout
Proximity sensors	Filter Average
Autotare	Value release Fast + reliable
Print mode	Autozero
	Last digit Always
	Ambient conditions Unstable

Filter settings depend on the working environment. For the best possible conditions the filter can work in a very fast mode (V.FAST value for Filter parameter); however, if the conditions are poor (shakes, drafts), the filter should be set to slow or very slow option (SLOW or V. SLOW value for Filter parameter). The effectiveness of the filter is different throughout the weighing range. The filter works slower when the weight value of weighed mass is about to be determined, it works more intensively when the weighed mass is within the set range of the filter (parameter for setting filter range is accessible only from the service menu – the user does not have any access to it).

Depending on the filter, the weighing time is shorter (V.FAST and FAST) or longer (SLOW and V. SLOW).



Caution: *The higher filter level, the longer the weighing takes.*

Value release (option disabled for the following profiles: Fast, Fast dosing, Precision)

Since ambient conditions at a workplace vary, it is necessary to determine the value release parameter in the most preferable way enabling weighing instrument adaptation, parameter options are: **FAST, FAST + RELIABLE** or **RELIABLE**. Depending on the selected option, weighing time is either shorter or longer.

Autozero function

The software offers an autozero function (**Auto**) ensuring precise mass indication. The function has been designed to enable automatic control and correction of zero indication. If the function is enabled, the following measurement results are compared to each other at declared time intervals, e.g. every second. The said comparison takes place when the weighing pan is unloaded and the displayed indication is close to zero. If the results difference is lower than declared AUTOZERO range value, e.g. 1 division, the indication gets zeroed automatically, and the markers of stable indication –  and precise zero – **0** are displayed. Active Autozero function means, that each measurement starts with the precise zero. There are, however, some cases when this function can be a disturbing factor for the measuring process. e.g. very slow placing of a load on the weighing pan (load adding, e.g. pouring, filling). In such case, the system correcting zero indication may also correct the indication of actual weight of load placed on the weighing pan.

Last digit display

Function enabling/disabling display of the last digit (placed on the right of the decimal point) of the weighing result. Available values:

- **Always:** all digits are displayed.
- **Never:** last digit disabled.
- **When stable:** last digit displayed only when the result is stable.

Balance ambient conditions

Parameter relating to ambient and environmental conditions of the workstation.

Available values: <STABLE> and <UNSTABLE>. Setting STABLE value makes the weighing instrument work much faster; i.e. weighing takes much less time than in the case of setting the parameter to UNSTABLE value. Enter <AMBIENT CONDITIONS> parameter and set <UNSTABLE> value if the ambient conditions are unfavourable (air drafts, vibrations). By default the parameter is set to value: <STABLE>.

12.12. Proximity Sensors

The weighing device is equipped with two proximity sensors which enable touch free control. The program detects two motions performed around the sensors:

1. Hand in a close vicinity to the left sensor <**Left sensor**>.
2. Hand in a close vicinity to the right sensor <**Right sensor**>.

Each motion can trigger optional weighing device function. For available functions list read section 8.2. Upon completed configuration procedure, the software runs function assigned to a particular proximity sensor, having detected motion around it. To provide correct operation, it is necessary to set respective proximity sensors sensitivity (*read section 12*).

12.13. AUTOTARE

Autotare function allows you to quickly determine net weight for loads with different tare values, which loads are measured one after another.

When autotare is enabled (<AUTOTARE> parameter set to <YES> value), operation takes the following order:

- Make sure that the weighing pan is empty and press zeroing key.
- Load the weighing pan with product packaging (packaging weight value must be greater than the set value of AUTO THRESHOLD parameter).
- Upon indication stabilization, packaging mass is **automatically tared (Net** pictogram is displayed in the upper part of the display).
- Put/pour/dispense product that is to be packed into the packaging.
- Net mass is displayed.
- Unload the weighing pan (remove both product and packaging).

- When the weighing device detects weight value lower than gross weight value set in <AUTO THRESHOLD> parameter, the entered tare value gets automatically deleted (**Net** pictogram is no longer displayed).
- Load the weighing pan with packaging of another product, upon indication stabilization, packaging mass is automatically tared (**Net** pictogram is displayed in the upper part of the display).
- Put/pour/dispense product that is to be packed into the packaging.

For correct operation of the weighing instrument with AUTOTARE function, it is necessary to adjust the threshold value.

<AUTO THRESHOLD> parameter refers to the following functions:



- autotare,
- automatic printout.

No automatic taring takes place as long as the gross weight value stays within the range set in <AUTO THRESHOLD> parameter.

12.14. Print Mode

Function designed to enable print mode setting.

Available values:

- <WHEN STABLE> - for this value stable measurement result, along with the settings for <GLP PRINTOUT> parameter, is sent to the printer port. Upon pressing  key at the moment when the result is unstable (no  pictogram displayed), the program first waits for the stability condition to be met, next sends the measurement result to the port.
- <EACH> - every single pressing of  key results with sending the measurement indication to the printer port along with the settings for <GLP PRINTOUT> parameter. Every single indication is sent (stable and unstable). In the case of unstable indication, <?> sign is displayed in front of the weighing result frame.
Function available for non-verified balances exclusively.
- <AUTO> - select this value to enable automatic printout. When selecting <AUTO> value remember to set <AUTOPRINT THRESHOLD> in accordance with your requirements.
- <AUTO + INTERVAL> - select this value to start automatic print and record of indications in WEIGHINGS and ALIBI databases, carried out in a cyclic manner in a specified time intervals. The interval is set in [min] in <INTERVAL> parameter. Interval range is 1 - 9999 min.

CAUTION:



Each weighing result is printed and recorded (stable and unstable for a non-verified balance, stable for a verified balance).

Automatic operation with interval starts at the moment of switching the function on.

The first stable weighing result of value greater than AUTO THRESHOLD value is printed and recorded as the first measurement. The following measurements are printed with frequency set in INTERVAL parameter. To stop the automatic operation with interval, switch the option off.

Upon switching the function of auto print with interval on, PRINT button becomes inoperative (no indication is printed when pressed).

Automatic operation procedure:

- Press  key to zero the indication (stability marker, , and zero pictogram, **+0-**, are displayed).
- Load the weighing pan, the first stable measurement is sent to the printer port.
- Unload the weighing pan.

- The next measurement is possible when the indication gets lower than the value set for <AUTO THRESHOLD> parameter (next measurement does not require zero value).

For automatic operation it is necessary to adjust the threshold value. The measurement is sent to a computer or a printer when mass indication gets below the set net value of <AUTO THRESHOLD> parameter.

<AUTO THRESHOLD> parameter refers to the following functions: automatic tare, automatic operation, autoprint with interval.

12.15. Minimum Sample Weight

Weighing mode comprises <Minimum sample weight> function. In order to use this function it is necessary to enter minimum sample weight (MSW) value and tare values for which the MSW value is to be obligatory. For standard PM C32 series the values are zero.

Only authorized RADWAG employee or operator with Administrator permissions level, providing that balance factory settings enable this, can carry out procedure aiming to determine minimum sample weight and next enter the respective data.

If you want to use this function, and your balance menu contains no minimum sample weight data, ask the nearest RADWAG office for help.

Using reference sample weights, the authorized RADWAG employee determines minimum sample weight for specified tare containers. This operation is carried out at the place of use and in accordance with requirements of the applied quality system. The obtained value is entered into the weighing instrument program.

The weighing instrument program enables defining tare value with assigned minimum sample weight value.

<Minimum sample weight> function guarantees that the results of weighing operation are comprised within the set tolerance, in accordance with applied quality management system of particular company.

Caution: Function valid for weighing mode exclusively.

Available options:

- **MODE**
 - None** – minimum sample weight function off.
 - Block** – select to enable display of respective pictograms informing you about the measured mass (whether it is lower than the MSW value or higher than the MSW value); with this option on, the program makes it impossible to accept the measurement that is lower than the MSW value.
 - Warn** – select to enable display of respective pictograms informing you about the measured mass (whether it is lower than the MSW value or higher than the MSW value). You can accept the measurement that is lower than the MSW value.
- **Tare** – maximum tare value, for which the minimum sample weight is obligatory (analyse the below examples).
- **Minimum mass** – value of the minimum sample weight determined for a particular weighing device on site with use of respective method.

Example 1:

No.	Tare value	Minimum Sample Weight	Operation
2	1000.00 g	1.00 g	Minimum sample weight refers to all net weight values when weighing is carried out using a tare container of mass 0.01 g – 999.99 g, inclusive (<TARE> button used).

			In the case of such settings, the minimum sample weight is valid only when you weigh samples in a tare container of weight value comprised within the above specified range. If taring function IS NOT used, or if the tare container's weight ranges between 1000.00 g - Max, then pictogram informing on use of minimum sample weight goes blank.
--	--	--	---

Example 2 (for a weighing instrument with max weighing range 10kg):

No.	Tare value	Minimum Sample Weight	Operation
1	10000.00 g	1.50 g	Minimum sample weight refers to all net weight values when weighing is carried out using a tare container of mass value comprised within the whole weighing range (<TARE> button used). In the case of such settings, the minimum sample weight is valid only when you weigh samples in a tare container. If taring function IS NOT used then pictogram informing on use of minimum sample weight goes blank.

Example 3:

No.	Tare value	Minimum Sample Weight	Operation
1	0.00 g	2.00 g	Minimum sample weight refers to all net weight values when weighing is carried out without use of a tare container (<TARE> button NOT used). In the case of such settings, the minimum sample weight is valid only when you weigh samples without use of tare containers. If taring function IS used then pictogram informing on use of minimum sample weight goes blank.

You can preview the entered data, but you are not allowed to edit it.

Weighing with use of MINIMUM SAMPLE WEIGHT function



If in the course of weighing you want to find out whether a particular measurement value is higher than the MSW value, specified for a given weighing range, then <Minimum sample weight> function must be on. To turn the function on go to weighing mode settings.

Procedure (Administrator exclusively):

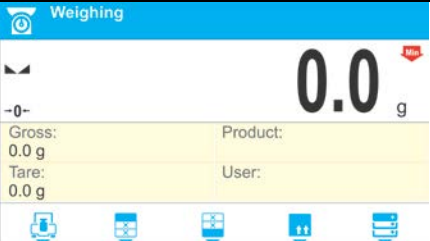
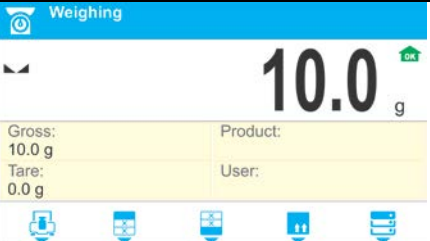
1. Enter weighing mode settings.
2. Enter <Minimum sample weight> parameter group.
3. Enter <Mode> parameter.
4. Settings box is displayed, select respective option:
 - Block** – select to enable display of respective pictograms informing you about the measured mass (whether it is lower than the MSW value or higher than the MSW value); with this option on, the program makes it impossible to accept the measurement that is lower than the MSW value.
 - Warn** – select to enable display of respective pictograms informing you about the measured mass (whether it is lower than the MSW value or higher than the MSW value). You can accept the measurement that is lower than the MSW value.
5. Go to the home screen.
6. Section presenting the weighing result comprises additional pictogram providing supplementary information. The pictogram changes in the course of weighing operation, it informs you on the weighed sample mass; the information is referred to the declared minimum sample weight value.

	
Weight value lower than the MSW value specified for a particular tare range.	Weight value higher than the MSW value specified for a particular tare range.

Pictograms Providing MSW-related Information:

	Weight value lower than the specified MSW value.
	Weight value higher than or equal to the specified MSW value.

13. MISCELLANEOUS PARAMETERS

Parameters facilitating balance operation. To set these parameters go to **<MISC>** submenu. For detailed instruction on how to set up particular parameters read section 7 of this user manual.



Interface Language

Parameter allowing you to set program menu language. Available languages: POLISH, ENGLISH.

'Beep' Sound

Parameter allowing you to enable/disable sound signal informing the operator about pressing panel key(s) or about operation of proximity sensors.

Settings box:

Sounds	
Button	
Proximity sensors	

Display Brightness

Parameter allowing you to change display brightness, the brightness can be changed within 0% - 100% range, where 0% - backlight off, 100% - maximum possible backlight intensity.

Proximity Sensors Sensitivity

Parameter allowing you to change sensitivity of the proximity sensors, the sensors sensitivity can be changed within 0% - 100% range, where 0% - proximity sensors off, 100% - maximum possible sensitivity (for lower values the proximity sensors operate at a shorter distance).

Date and Time

Parameter allowing you to set current date and time and to specify date and time format.

Date and time	
Date	2017.03.20
Time	13:30:45
Date format	YYYY.MM.DD
Time format	24h

Date

Enter this parameter to set current date.

Settings box:

Date

 2017-03-20

◀ Cancel
Confirm ▶

Using the operation panel's numeric keypad enter the new date and press  key to confirm.

Time

Enter this parameter to set current time. Time and date parameters modification proceeds likewise.

Date Format

Enter this parameter to set date format [YYYY.MM.DD / YYYY.DD.MM / DD.MM.YYYY / MM.DD.YYYY]; where: YYYY – year; MM – month; DD – day.

Time Format

Enter this parameter to set time format [12h/24h].

When you set [12h] value for **TIME** parameter, **A**> or <**P** letter is displayed next to the time. **A** stands for hours before the noon, **P** stands for hours after the noon. Time printout features either letters **AM** or **PM**.

Backlight Standby Time

Parameter allowing you to set time interval, in [min], after which the screen goes black when no weighings are being carried out. The screen will go black if the weighing result is stable.

NONE - backlight standby time inactive, **0.5; 1; 2; 3; 5** - time given in minutes.

If the indication is stable during the declared time interval, the backlight gets deactivated automatically. Backlight activates upon indication change (stability marker not displayed) or upon pressing operation panel key. Backlight deactivation works also when the weighing instrument's menu is entered.

Automatic Shutdown

Parameter allowing you to set time interval, in [min], after which the weighing device shuts down automatically (this function is similar to function of  key). Upon switching the display off, the other subassemblies remain powered and the weighing instrument is ready for operation.

NONE - automatic shutdown inactive, **1; 2; 3; 5; 10** - time given in minutes.
If the indication is stable during the declared time interval, the screen is shut down automatically.

In order to switch the weighing instrument on, press  key of the operation panel. Weighing process gets started automatically.

Shutdown function is inactive and the device cannot be turned off if any process is started or if you operate the menu.

Restore Default Operator Settings

Parameter allowing you to restore default operator settings.

Autotest GLP

Autotest GLP is a function based on the test of repeatability of indications observed while loading an internal weight onto the weighing pan, which is done in order to determine indication error. The error is determined in reference to the maximum capacity.

<AUTOTEST> function has been designed to aid a user in assessing balance's operation and diagnosing the reasons for occurrence of weighing errors (exceeding the maximum permissible values for a given balance model).

AUTOTEST facilitates balance's settings optimisation which is necessary in order to maintain the best possible repeatability and weighing time at workstation. The function makes it possible to monitor the above-mentioned parameters at optional moment and archive tests results in the form of reports that are automatically generated at the end of control procedure. Up to 50 reports can be recorded.

Procedure:



- deposit internal weight twice, next deposit internal weight ten times and calculate the value of standard deviation,
- adjust the weighing instrument,
- print a report.

Test results provide weighing instrument data, calculated error for Max capacity and value of repeatability of indication expressed as standard deviation.

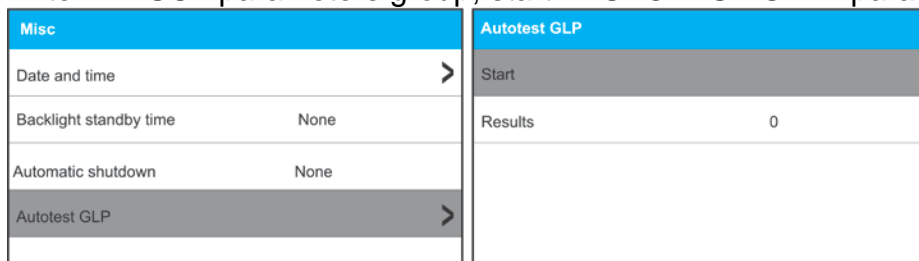

Procedure:

Enter <MISC> parameters group, start <AUTOTEST GLP> parameter.



Select <Start> option, to do it press either  or . Autotest GLP procedure starts, it is carried out automatically. Autotest procedure progress bar is displayed in a separate window.



Press  or  key to abort the procedure, you can do it at any time.

Upon procedure completion, the parameter screen is displayed, value informing on recorded autotest number (to be found in <RESULT> field) is increased by <1>. To view particular results, press <RESULTS> field and select the given autotest.

To print a report go to <Details> screen and press printer pictogram that is to be found in the bottom.

Report example:

```
.....  
----- Autotest GLP: Report -----  
Balance type                xx  
Balance S/N                 123456  
Operator                    Admin  
Software version            Lx.x.x  
Date                        2017.03.10  
Time                        09:17:16  
-----  
Measurements quantity       10  
Reading unit                 0.01 g  
Adjustment weight mass      1402.094 g  
Filter                       Average  
Value release                Fast + reliable  
-----  
Deviation for max            -0.018 g  
Repeatability                0.0028 g  
Signature  
.....
```

14. PERMISSIONS LEVELS

<Permissions> submenu is available for operators logged as **Administrator**. This group of parameters allows you to determine access rights for particular operators.

In order to set permissions levels enter <  /Permissions> submenu.

14.1. Anonymous Operator

Parameter allowing you to assign unlogged weighing device operator (so called anonymous operator) with permissions level.

Procedure:

- Enter <Permissions/Anonymous operator> submenu.
- Set one of four options: None, Operator, Advanced operator, Administrator.

14.2. Date and Time

Default balance settings enable operator who is logged as **Administrator** to modify date and time parameter but the software allows to change permissions level, and as a result authorize other operators to access <Date and time> parameter.

Procedure:

- Enter <Permissions/Date and time> submenu.
- Set one of four options: None, Operator, Advanced operator, Administrator.

Caution: When <None> option is set, all unlogged operators can modify date and time.

14.3. Printouts

Default balance settings enable operator who is logged as **Administrator** to edit printouts but the software allows to change permissions level, and as a result authorize other operators to access <Printouts> parameter.

Procedure:

- Enter <Permissions/Printouts> submenu.
- Set one of four options: None, Operator, Advanced operator, Administrator.

Caution: When <None> option is set, all unlogged operators can edit printouts.

14.4. Databases Edition

Parameter allowing you to set permissions levels enabling particular operators to edit the following databases: products, packaging, customers, universal variables.

Procedure:

- Enter <Permissions/Databases edition> submenu.
- Select respective database and set one of four options: None, Operator, Advanced operator, Administrator.

Caution: When <None> option is set, all unlogged operators can edit particular database.

14.5. Select Database Record

Parameter allowing you to set permissions levels enabling particular operators to select given database entries. 'Select database record' parameter is available for the following databases: products, packaging, customers, universal variables.

Procedure:

- Enter **<Permissions/Select database record>** submenu.
- Select respective database and set one of four options: None, Operator, Advanced operator, Administrator.

Caution: When **<None>** option is set, all unlogged operators can select particular database entries.

15. ADJUSTMENT

In order to ensure the highest weighing accuracy, it is recommended to periodically introduce a corrective factor of indications to balance memory, the said factor must be referred to a reference mass.

Adjustment has to be carried out:

- prior to weighing,
- if long breaks between successive measuring series occur,
- if the weighing instrument temperature has changed by 3°C and more.

Types of adjustment:

- automatic internal adjustment,
- manual internal adjustment,
- adjustment performed using an external weight of declared mass, which mass cannot be modified, or using an external weight of mass equal or greater than 30% of the maximum range.



Caution:

*In the case of verified balances (with an internal automatic adjustment system) only two adjustment types are available: automatic internal adjustment and manual internal adjustment. Remember to carry out the adjustment process when there is no load on the pan! When the weighing pan is loaded, command **<RANGE EXCEEDED>** is displayed. In such case, unload the weighing pan and repeat the adjustment.*

Adjustment process can be aborted if necessary, to do it press  key.

15.1. Internal Adjustment

Internal adjustment is carried out by means of an internal adjustment weight.  button, when pressed, automatically triggers adjustment process. Upon adjustment process completion respective message, informing about process end and about its status, is displayed.



Caution: Adjustment procedure requires stable environmental conditions (no air drafts or ground vibrations). The process must be carried out with an empty weighing pan.

15.2. External Adjustment

External adjustment is carried out using an external mass standard of the right accuracy and weight value, which value depends on balance model and capacity. Correction is carried out semi-automatically, successive process stages are signalled with prompts.

Caution: *External adjustment is possible for balances that are not a subject to the conformity assessment (verification).*

Process stages:

- Enter <Adjustment> submenu, next select “External adjustment” option.
- Message <Remove weight> is displayed.
- Unload the weighing pan and press  key. The balance determines start mass, message <Adjustment; Please wait...> is displayed.
- Upon completed start mass determination, message <Put weight> is displayed along with particular value of mass standard assigned to the balance.
- Load the weighing pan with the required adjustment weight and press  key.
- Upon completed procedure, message <Remove weight> is displayed.
- Take the weight off the weighing pan, the balance displays the <Adjustment> submenu.

15.3. Operator's Adjustment

Operator's adjustment can be carried out using any adjustment weight, mass of which ranges between 0.3 Max and Max. Operator's adjustment and external adjustment procedures are likewise with one exception, before operator's adjustment start, an edit box for entering mass of the used adjustment weight is opened.

Caution: *Operator's adjustment is possible for balances that are not a subject to the conformity assessment (verification).*

In order to start operator's adjustment, enter <Adjustment> submenu and select <User adjustment> option. Then follow the commands displayed on a screen.

15.4. Adjustment Test

<Adjustment test> function enables comparing the result of an internal automatic adjustment with the value recorded in balance factory parameters. The comparison is used for determining balance sensitivity drift over time.

15.5. Automatic Adjustment

Enter this menu to specify conditions initiating an automatic adjustment. Options:

- None – automatic adjustment inactive.
- Time – adjustment takes place in time intervals declared in menu <Automatic adjustment time> (14.6).
- Temperature – adjustment is triggered by temperature change.
- Both – adjustment is triggered by both, temperature changes and time.

Caution: *This parameter settings can be modified only for balances that are not a subject to the conformity assessment (verification).*

15.6. Automatic Adjustment Time

<Automatic adjustment time> parameter determines time interval between successive automatic internal adjustments. The time interval is declared in hours and ranges between 0.5 and 12 hours.

To set time interval for automatic adjustment:

- select <Automatic adjustment time> option,
- using displayed menu, select appropriate time interval (given in hours) which is to elapse between the most recent adjustment and activation of the following automatic internal adjustment.

Caution: *This parameter settings can be modified only for balances that are not a subject to the conformity assessment (verification).*

15.7. Print

Adjustment report is automatically generated at the end of each adjustment process or adjustment test, next it is sent to port selected for <PERIPHERALS/PRINTER> (COM 1 port by default). To declare report content go to <PRINTOUTS/ADJUSTMENT REPORT> submenu.

For instruction on how to declare adjustment report settings read section 'Printouts'.

The report can be printed using balance-connected printer or sent to a computer and saved as a file for the archiving purposes.

16. PRINTOUTS CONTENT

16.1. Adjustment Report

ADJUSTMENT REPORT is a group of parameters allowing you to declare data that is to be printed on an adjustment report.



Adjustment Reports	
Project	
Adjustment type	✓
User	✓
Project	✓
Date	✓

Variable	Description
PROJECT	Project name matching particular weighing type (31 characters maximum).
ADJUSTMENT TYPE	Performed adjustment type.
OPERATOR	Logged-in operator name.
PROJECT	Project name printout (see: Project parameter).
DATE	Adjustment performance date.
TIME	Adjustment performance time.
BALANCE S/N	Balance serial number.
ADJUSTMENT RESULT DIFFERENCE	Difference between mass of adjustment weight that was measured during last adjustment and mass of currently measured adjustment weight.
DASHES	Line separating data and signature fields on a printout.

SIGNATURE	An area for the signature of an operator carrying out the adjustment.
------------------	---

For detailed information on how to enter project name read section 7 of this user manual.

For the parameters described above, one of these values must be selected:

-  **(NO)** – do not print
-  **(YES)** – print

Report example:

Rodzaj kal.	Wewnetrzna
Uzytkownik	Admin
Projekt	Nazwa projektu-1
Data	04.06.2013
Czas	10:54:27 AM
Nr wagi	353870
Roznic. kal.	0.045 g

Podpis	_____
.....	

16.2. Header, Footer, GLP Printouts

HEADER	Group of parameters allowing you to declare data that is to be printed on a header printout.												
	<table border="1"> <thead> <tr> <th colspan="2">Header</th> </tr> </thead> <tbody> <tr> <td>Dashes</td> <td style="text-align: center;">✓</td> </tr> <tr> <td>Working mode</td> <td style="text-align: center;">✓</td> </tr> <tr> <td>Date</td> <td style="text-align: center;">✓</td> </tr> <tr> <td>Time</td> <td style="text-align: center;">✓</td> </tr> <tr> <td>Balance type</td> <td style="text-align: center;">✓</td> </tr> </tbody> </table>	Header		Dashes	✓	Working mode	✓	Date	✓	Time	✓	Balance type	✓
Header													
Dashes	✓												
Working mode	✓												
Date	✓												
Time	✓												
Balance type	✓												
GLP PRINTOUT	Group of parameters allowing you to declare data that is to be printed on a measurement printout.												
	<table border="1"> <thead> <tr> <th colspan="2">GLP Printout</th> </tr> </thead> <tbody> <tr> <td>Date</td> <td style="text-align: center;">✓</td> </tr> <tr> <td>Time</td> <td style="text-align: center;">✓</td> </tr> <tr> <td>User</td> <td style="text-align: center;">✓</td> </tr> <tr> <td>Product</td> <td style="text-align: center;">✓</td> </tr> <tr> <td>Customer</td> <td style="text-align: center;">✓</td> </tr> </tbody> </table>	GLP Printout		Date	✓	Time	✓	User	✓	Product	✓	Customer	✓
GLP Printout													
Date	✓												
Time	✓												
User	✓												
Product	✓												
Customer	✓												
FOOTER	Group of parameters allowing you to declare data that is to be printed on a footer printout.												
	<table border="1"> <thead> <tr> <th colspan="2">Footerka</th> </tr> </thead> <tbody> <tr> <td>Working mode</td> <td style="text-align: center;">✓</td> </tr> <tr> <td>Date</td> <td style="text-align: center;">✓</td> </tr> <tr> <td>Time</td> <td style="text-align: center;">✓</td> </tr> <tr> <td>Balance type</td> <td style="text-align: center;">✓</td> </tr> <tr> <td>Balance S/N</td> <td style="text-align: center;">✓</td> </tr> </tbody> </table>	Footerka		Working mode	✓	Date	✓	Time	✓	Balance type	✓	Balance S/N	✓
Footerka													
Working mode	✓												
Date	✓												
Time	✓												
Balance type	✓												
Balance S/N	✓												

Variables List

Variable	Description	Active for
WORKING MODE	Working mode name printout.	Header Footer

BALANCE TYPE	Balance type printout.	Header Footer
BALANCE S/N	Balance serial number.	Header Footer
OPERATOR	Logged-in operator name.	Header GLP printout Footer
PRODUCT	Currently selected product name.	Header GLP printout Footer
CUSTOMER	Currently selected customer name.	Header GLP printout Footer
PACKAGING	Currently selected customer name.	GLP printout
DATE	Printout date.	Header GLP printout Footer
TIME	Printout time.	Header GLP printout Footer
VARIABLE 1	Value of universal variable 1.	Header GLP printout Footer
VARIABLE 2	Value of universal variable 2.	Header GLP printout Footer
VARIABLE 3	Value of universal variable 3.	Header GLP printout Footer
NET	Net weight value in a basic unit (calibration unit).	GLP printout
TARE	Tare weight value in the current unit.	GLP printout
GROSS	Gross weight value in the current unit.	GLP printout
CURRENT RESULT	Current measurement result (NET weight value) in the current unit.	GLP printout
ADJUSTMENT REPORT	The most recent adjustment report printed according to the settings declared for the adjustment report printout (read: section 15.1 of this user manual).	Header GLP printout Footer
DASHES	Line separating data and signature fields on a printout.	Header Footer
EMPTY LINE	Blank separating line.	Header Footer
SIGNATURE	An area for the signature of an operator carrying out the adjustment.	Footer
PROFILE	Currently selected profile name.	Header GLP printout Footer
NON-STANDARD PRINTOUT	One of 100 non-standard printouts. You can choose one of the following options: NONE / non-standard printout name.	Header GLP printout

	For instruction on how to enter non-standard printouts read later section of this user manual.	Footer
--	--	--------

For the parameters described above, one of these values must be selected:

✓ **(NO)** – do not print; ✓ **(YES)** – print

Printout examples:

Working modes	Weighing
Date	24.07.2013
Time	7:37:30
ScaleType	AS
Balance ID	10353870
User	ADMIN ENG
Product	Tablet

Header

Date	04.06.2013
Time	11:11:24 AM
Product	NAZWA
	0.000 g

GLP printout

Date	24.07.2013
Time	7:41:10
User	ADMIN ENG
Signature	
.....	

Footer

16.3. Non-Standard Printouts

The program allows you to design 100 non-standard printouts. Each of them can consist of approximately 1900 characters.

Non-standard printout may include:

- variable data conditioned by a particular working mode and operator needs (mass, date etc.),
- fixed texts, entered into operator's menu,

16.3.1. Inserting Texts

Variables list

Symbol	Description
{0}	Standard printout in a calibration unit
{1}	Standard printout in a current unit
{2}	Date
{3}	Time
{4}	Date and time
{5}	Working mode
{6}	Net weight in a current unit
{7}	Net weight in a calibration unit
{8}	Gross weight in a calibration unit
{9}	Tare in a calibration unit
{10}	Current unit
{11}	Calibration unit
{12}	MIN threshold
{13}	MAX threshold
{15}	Statistics: Number

{16}	Statistics: Sum
{17}	Statistics: Average
{18}	Statistics: Min
{19}	Statistics: Max
{20}	Statistics: SDV
{21}	Statistics: D
{22}	Statistics: RDV
{32}	Serial number
{35}	Parts counting: Reference sample mass
{36}	Percent weighing: Reference mass
{45}	Target value
{46}	Tolerance
{50}	Product: Name
{51}	Product: Code
{52}	Product: EAN code
{53}	Product: Mass
{54}	Product: Tare
{56}	Product: Min
{57}	Product: Max
{66}	Product: Tolerance
{70}	Variable 1
{71}	Variable 2
{72}	Variable 3
{75}	Operator: Name
{76}	Operator: Code
{77}	Operator: Permissions
{80}	Packaging: Name
{81}	Packaging: Code
{82}	Packaging: Mass

{85}	Customer: Name
{86}	Customer: Code
{87}	Customer: TIN
{88}	Customer: Address
{89}	Customer: Postal code
{90}	Customer: City
{146}	Gross weight in current unit
{147}	Tare in a current unit
{150}	Paper crop EPSON
{151}	Form feed for PCL printers
{155}	Cooperation with RADWAG CONNECT software

Each of them can consist of approximately 1900 characters (letters, digits, special signs, spaces). You can apply non-standard characters, i.e. special signs, which allows you to print variable data.

Example:

„RADWAG”
DATE: <current measurement date>
HOUR: <current measurement time>
PRODUCT MASS: <current mass indication>

*****SIGNATURE:.....
 <current working mode>

Enter printout content settings and design the printout using respective data variables and characters for text format.

For detailed information on how to enter/design project read section 7 of this user manual.

In order to carry out HEADER or GLP or FOOTER printout using EPSON printer (equipped with an auto-cutter blade) and crop the paper beneath the respective printout, select an option of non-standard printout comprising {150} variable, and set this option in header, GLP printout or footer settings, respectively. (*For instruction on how to enter control codes, read section 25 of this user manual*).

In such case <SUFFIX> command should stay empty. Paper is to be cropped underneath the FOOTER.

Method for inserting the text

- **by an on-screen keyboard** (detailed description to be found in section 7 of this user manual)
- **by a computer keyboard of USB type**

A computer keyboard of USB type can be connected to a balance, this enables easier and quicker editing of the printouts. Willing to insert any text, it is necessary to select a respective menu option and, using the keyboard, type the text.









16.4. Variables

Variable is defined as alphanumeric data which can be linked to printouts, products or other information related to weighing. Every variable is characterized by its content, the content must be inserted. Variables are used for entering various data during the weighing process, e.g. serial number or batch number. The program allows to enter 3 variables. Each can consist of 31 characters maximum.

In order to insert a variable content, you need to enter variable settings (VARIABLE 1, VARIABLE 2, VARIABLE 3) and insert the respective values using arrow keys of the balance keypad or a computer keyboard. Procedure for entering texts is the same as for non-standard printouts.

17. WORKING MODES – General Information

PM series balances feature the following working modes:

	<p>Weighing Means of operation: weight of a load is determined through an indirect measurement. The balance measures gravitational force which attracts the load. The obtained result is processed and displayed on the balance screen in a digital format.</p>
	<p>Parts Counting Means of operation: based on a weight value of a single piece it is possible to count pieces quantity; necessary conditions: the weight value of a single piece is determined with sufficient accuracy, the mass of all the pieces is the same.</p>
	<p>Checkweighing Means of operation: control of sample's mass carried out with reference to specified thresholds, it is necessary to give the value of min threshold <LO> and max threshold <HI>.</p>
	<p>Dosing Means of operation: it is necessary to specify sample's target mass to be obtained by dispensing (pouring, filling, etc.).</p>
	<p>Percent weighing Means of operation: control of percent ratio of a test sample in relation to a reference sample. Obtained data provides info on how much the test sample differs from the adopted reference sample.</p>
	<p>Solids density Means of operation: based on Archimedes principle, a balance determines density of solids. The mode requires use of an optional density determination kit.</p>
	<p>Liquid density Means of operation: based on Archimedes principle, a balance determines density of liquids. The mode requires use of an optional density determination kit.</p>
	<p>Animal Weighing Means of operation: mass measurement carried out with use of filters which dampen animal moves on a weighing pan, the filters enable you to obtain a correct measurement result.</p>
	<p>Statistics Means of operation: carried out measurements are used to calculate statistical data such as Min, Max, deviation, etc.</p>

	<p>Peak Hold Means of operation: max temporary indication occurring in the course of the weighing process is held on a display.</p>
	<p>Formulations Means of operation: by mixing specified ingredients you can obtain particular mixture, in order to program given formulation it is necessary to give mass values for particular ingredients.</p>
	<p>Basic totalizing function allowing to add net masses of weighed samples.</p>

Particular working modes feature specific settings. The settings enable adapting mode operation to your individual needs. They are activated upon selecting a respective profile. For detailed description of specific working mode settings refer to the given working mode section.

17.1. Working Modes Accessibility

This group of parameters allows you to declare which functions are to be accessible. You can deactivate functions that are not used in the course of balance operation, to do it, set the

accessibility parameter to **<NO** **>** value.

Procedure:

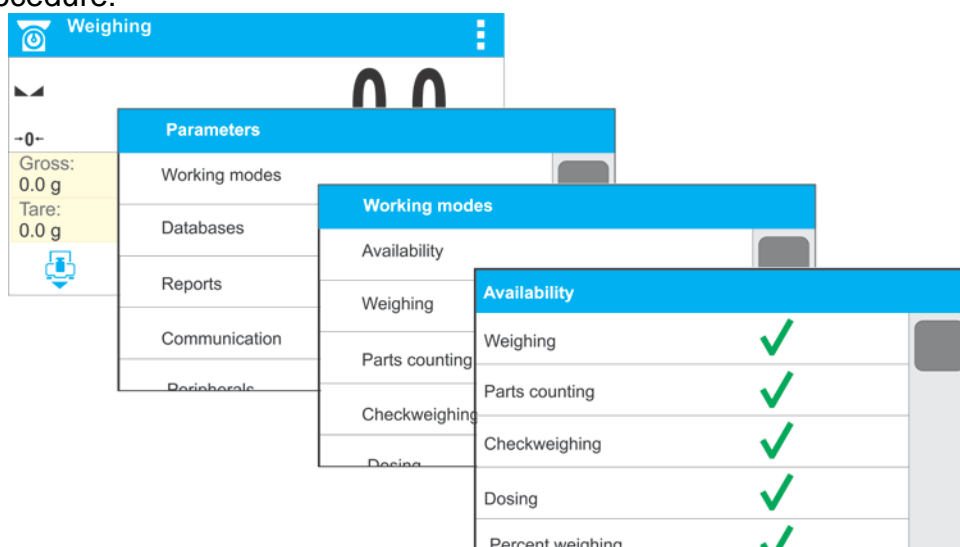

17.2. Running Working Mode

To run working mode other than currently operated one:

- Press key.

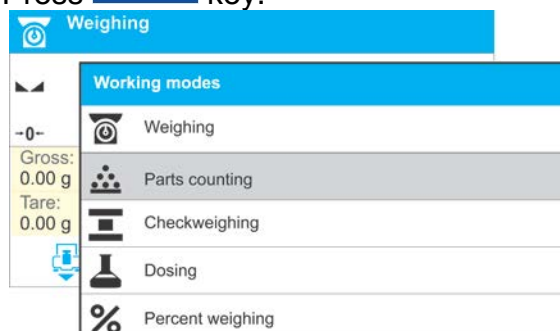

- List of working modes is displayed.

- Using either **8 TUV** or **3 DEF** key, select the working mode that is to be operated (grey field).
- Press **↶/⊙** key to confirm.

17.3. Working Mode Parameters

Each working mode has programmable parameters determining its functioning. For overview of WEIGHING mode parameters, read section 9 of this user manual. Settings related to remaining working modes are to be found in respective sections describing particular working modes.

18. PARTS COUNTING

 **<Parts counting>** is a working mode enabling you to determine quantity of small pieces of the same mass, which determination is done on the basis of reference weight value of single piece. The single piece weight value can be:

- determined using a reference quantity of parts subjected to weighing,
- taken from products database,
- entered manually as a numeric value.

Procedure for activation of Parts Counting mode:

- Select **<Parts counting>** mode, the home screen is displayed automatically, wherein the top bar of the screen features  pictogram.

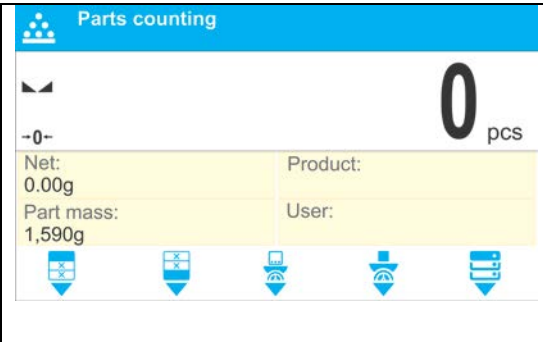
	<p>Info field provides the following information:</p> <ul style="list-style-type: none"> • Net weight • Part mass • Product • Operator • Buttons: print header, print footer, set part mass, determine part mass (using reference quantity of parts), databases
---	---

18.1. Mode Related Settings

The supplementary settings enable you to adjust the working mode to your needs and requirements. To access the settings follow the below procedure.

Procedure:

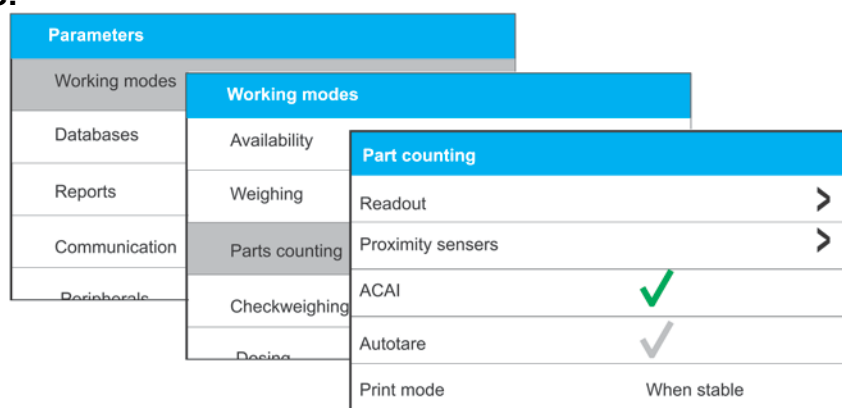

Parameters	
Working modes	Working modes
Databases	Availability
Reports	Weighing
Communication	Parts counting
Peripherals	Readout >
	Proximity sensors >
	ACAI ✓
	Autotare ✓
	Print mode When stable

ACAI, Automatic Accuracy Correction, provides the following options:

- YES, weight value of single piece to be updated,
- NO, weight value of single piece not to be updated.

Means of operation of ACAI function:

1. pieces quantity upon adding must increase,
2. pieces quantity upon adding cannot increase more than twice,
3. pieces quantity upon adding must be comprised within ± 0.3 tolerance of total value,
4. the weighing result must be stable.

For information on how to operate the remaining settings and parameters read section 11 of this user manual, i.e. *WEIGHING Mode Settings*.

18.2. Parts Counting – Quick Access Keys

Each working mode features automatically displayed set of default keys. The set can be modified by assigning out-of-list quick access keys to the on-screen buttons. Such operation requires particular permissions level.

List of quick access keys it to be found in section 8 of this user manual.

18.3. Setting Reference Sample Mass by Entering Mass of a Single Part

Procedure:



Press  button (Set part mass), <Part mass> edit box featuring an on-screen numeric keyboard is displayed.



- Enter respective value and press  key for confirmation, <Parts counting> working mode is run with automatically set mass of a single part.

Caution:

*If the value of entered single part mass is lower than 0.1 of the reading unit, then the following message is displayed: **<Value too low>**.*

18.4. Setting Reference Sample Mass by Determining Mass of a Single Part

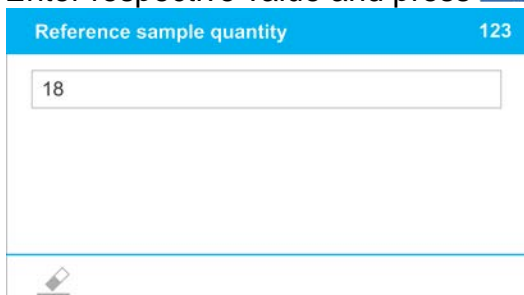

Procedure:

- Put the container (intended for the reference sample) on a weighing pan and tare it.
- Press  button (Determine part mass), <Reference sample quantity> edit box featuring an on-screen numeric keyboard is displayed.
- Enter respective value and press  key to confirm changes.

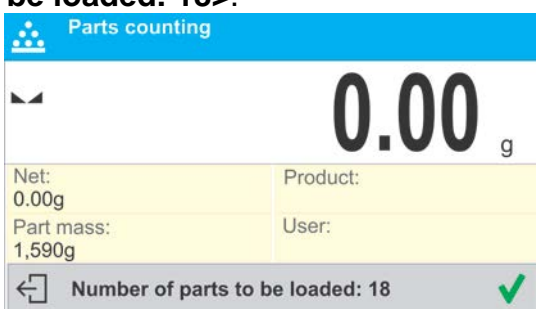

- Message specifying number of parts to be loaded is displayed: **<Number of parts to be loaded: 18>**.



- Load the weighing pan with declared amount of parts. When the indication is stable ( pictogram is displayed), press  key to confirm the mass.

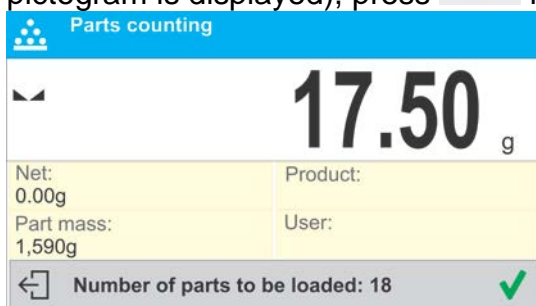

- Single part mass is calculated automatically, <Parts counting> working mode is run and the weighing device displays quantity of single parts (**pcs**).

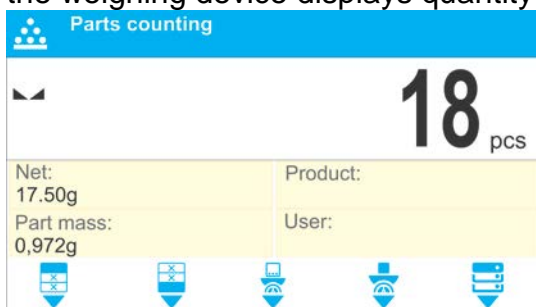

Caution: Remember:

- Total weight value of all parts loaded onto the weighing pan cannot be greater than the max capacity value.
- Total weight value of all parts loaded onto the weighing pan cannot be lower than the value determined by **<Minimum reference sample mass>** parameter. Unless this condition is met, the weighing device displays a message: **<Sample mass too low>**.

- *Single part mass must be equal or greater than 0.1 reading unit. Unless this condition is met, the weighing device displays a message: <Single part mass too low>.*

18.5. Setting Reference Sample Mass by Acquiring Mass of a Single Part from Database

Each product recorded in a database of products features set of information which allow to identify it. Among the information there is weight value used during part counting process.

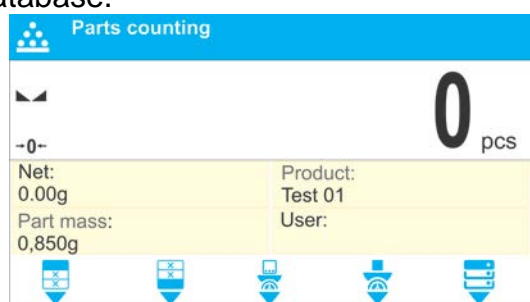

Procedure:

Enter <Parts counting> mode and press operation panel key to which  pictogram (product database) is assigned, next select given product from the list. <Parts counting> mode is displayed, the weight value for a single piece is automatically acquired form the product database.



Entering reference sample mass to weighing device memory

Procedure for entering the weight value of a single part to products database:

- Press operation panel key to which  pictogram (product database) is assigned.
- Products database opens, press <Products> field.
- Press  key in order to select function <Fn> (active functions assigned to 1,2,3,4,5 keys are displayed in the bottom part of the display).
- Press operation panel key to which  pictogram (add product) is assigned.
- Fill in the following fields (Name, Code, EAN, Mass – for Parts Counting mode it is single piece weight).
- Go back to <Parts counting> mode.

18.6. Parts Counting Procedure

First, it is necessary to obtain data about weight value of a single piece.

You can choose one of the following options:

- Enter weight value for a single part (section 17.3), next put parts to be counted on the weighing pan, parts quantity is displayed.
- Determine weight value for a single part using reference sample mass of known quantity (section 17.4). Next put parts to be counted on the weighing pan, parts quantity is displayed. In the course of calculation, ACAI function pictogram is visible  (providing that the function is on).
- Acquire weight value for a single part from the database (section 17.5). To do it, you have to select respective product. Now put parts to be counted on the weighing pan, parts quantity is displayed.

Caution: It is necessary to tare any additional elements (packaging) prior to counting process start.

With single part mass set, put parts to be counted into tare container weight of which has been stored by balance memory.

Number of weighed pieces is displayed on a screen.

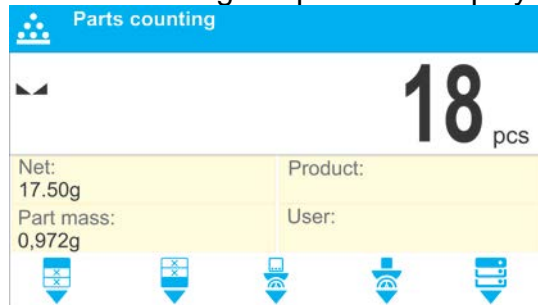

You can print stable measurement (stability pictogram displayed), to do it press  key.

19. CHECKWEIGHING

 **Checkweighing** is a working mode using two thresholds (Min and Max) for control of samples weight. Usually the weight is considered to be correct if it is comprised within threshold values.

Procedure for activation of Checkweighing mode:

- Select <Checkweighing> mode, the home screen is displayed automatically, wherein the top bar of the screen features  pictogram.

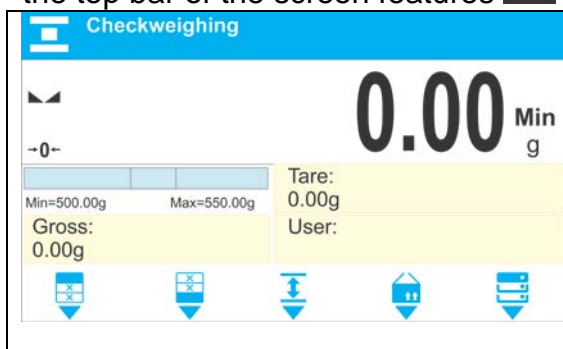

Info field provides the following information:

- Bar graph with checkweighing thresholds
- Gross weight
- Tare weight
- Operator
- Buttons: print header, print footer, set checkweighing thresholds, product, databases

19.1. Mode Related Settings





The supplementary settings enable you to adjust the working mode to your needs and requirements. For means of operation of these functions read point 11 *WEIGHING Mode Settings*. You can place the bar graph within information field area. Below the bar graph, Min and Max threshold values are displayed.

19.2. Checkweighing – Quick Access Keys

Each working mode features automatically displayed set of default keys. The set can be modified by assigning out-of-list quick access keys to the on-screen buttons. Such operation requires particular permissions level. List of quick access keys it to be found in section 8 of this user manual.

19.3. Making Use of Checkweighing Thresholds

There are two methods for making use of the checkweighing thresholds:



- selecting product <  > with Min and Max threshold declared,
- entering numeric value for the thresholds using <  > or <  > or <  > button, in this case thresholds do not refer to any product.

Procedure 1 – selecting product from Products Database:

- Press  button (product selection), list of products is displayed.
- Select the product that is to be weighed.
- The balance displays threshold values under the bar graph within the INFO area. Bar graph colour corresponds to the current status of mass:
 - yellow: mass value lower than Min value,
 - green: mass value higher than MIN value and lower than MAX value,
 - red: mass value higher than MAX value.







Procedure 2 – entering checkweighing thresholds manually:

- Press  button (Checkweighing thresholds).
- Window with an on-screen numeric keypad is displayed, using it enter Min Threshold value.
- Enter the value, press  key.
- Window with an on-screen numeric keyboard is displayed, using it enter Max Threshold value.
- Enter the value, press  key.
- Home screen of the Checkweighing mode along with the entered threshold values is displayed.

Caution: Max threshold value has to be greater than Min threshold value.

In order to modify threshold values, the following buttons can be used:

-  - press to modify Min Threshold value, do it using an on-screen numeric keypad. Enter the value, press  key. Home screen of the Checkweighing mode is displayed automatically.

-  - press to modify Max Threshold value, do it using an on-screen numeric keypad. Enter the value, press  key. Home screen of the Checkweighing mode is displayed automatically.

20. DOSING

 **Dosing** is a working mode that facilitates dispensing process, wherein the dispensing takes as long as it is necessary to obtain a pre-defined target weight.

Procedure for activation of Dosing mode:

- Select <Dosing> mode, the home screen is displayed automatically, wherein the top bar of the screen features  pictogram.

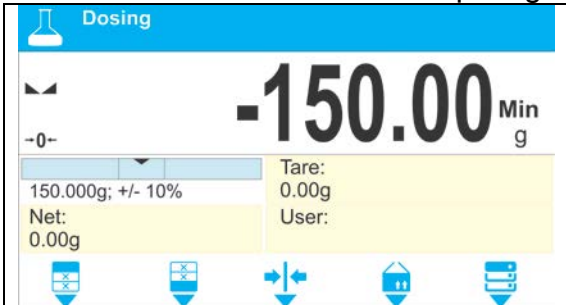
	<p>Info field provides the following information:</p> <ul style="list-style-type: none"> • Bar graph with target weight value • Net weight • Tare weight • Operator • Buttons: print header, print footer, set target weight value, product, operator
---	---

20.1. Mode Related Settings

The supplementary settings enable you to adjust the working mode to your needs and requirements. For means of operation of these functions read point 11 *WEIGHING Mode Settings*. You can place the bar graph within information field area. Below the bar graph the following values are displayed: target weight and tolerance.

20.2. Dosing – Quick Access Keys

Each working mode features automatically displayed set of default keys. The set can be modified by assigning out-of-list quick access keys to the on-screen buttons. Such operation requires particular permissions level. List of quick access keys it to be found in section 8 of this user manual.

20.3. Making Use of Products Database in the Course of Dosing Operation

You can use target value assigned to a product or values recorded in Product Database. Additionally it is possible to define temporary target values. In the case of Product Database the target value is value entered in the mass field.

Procedure 1 – selecting product from Products Database:

- Press  button (Product database), list of products is displayed.
- Select the product that is to be weighed.
- Target and tolerance values are displayed automatically within the bar graph area.
- Target value is displayed with minus sign.

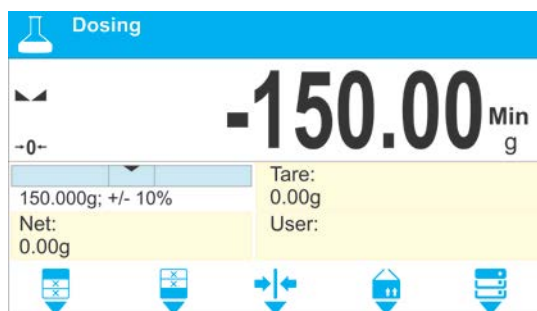

- Bar graph colour corresponds to the current status of mass:
 - yellow: mass value lower than 'target value - tolerance value',
 - green: mass value within permissible tolerance range: 'target value + tolerance value',
 - red: mass value greater than 'target value + tolerance value'.

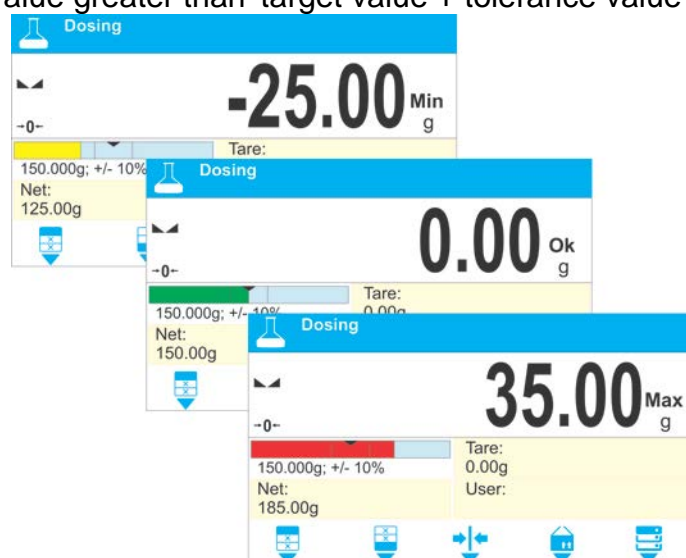

Procedure 2 – entering target value manually:

- Press button (Target value).
- Window with an on-screen numeric keypad is displayed, using it enter the target value. Confirm.
- Window with an on-screen numeric keypad is displayed again, this time use it to enter the tolerance value. Confirm.
- Home screen is displayed automatically.

21. PERCENT WEIGHING AGAINST REFERENCE SAMPLE MASS

Percent weighing is a working mode for comparison of the measured sample's weight with the reference mass. The result is expressed in [%].

Procedure for activation of Percent Weighing mode:





- Select **<Percent weighing>** mode, the home screen is displayed automatically, wherein the top bar of the screen features pictogram.

% Percent weighing

0.00 %

-0-

Net: 0.00 g	Product:
Reference mass: 0.00g	User:

Info field provides the following information:

- Net weight
- Reference mass
- Product
- Operator
- Buttons: print header, print footer, set reference mass, determine reference mass (set as 100 %), databases

21.1. Mode Related Settings



The supplementary settings enable you to adjust the working mode to your needs and requirements. For means of operation of these functions read point 11 *WEIGHING Mode Settings*.

21.2. Percent Weighing – Quick Access Keys



Each working mode features automatically displayed set of default keys. The set can be modified by assigning out-of-list quick access keys to the on-screen buttons. Such operation requires particular permissions level. List of quick access keys it to be found in section 8 of this user manual.

21.3. Mass Comparison of the Sample and the Reference Sample

There are few methods of comparison of measured sample weight with reference mass:

- entering reference mass; to do it press  button (Set reference mass),
- accepting mass of load resting on the weighing pan as a reference mass; to do it press  button (Determine reference mass (set as 100%)),
- selecting product, out of products database, for which 'mass' parameter has been defined; to do it press <Product> button.

Procedure 1 – entering reference mass manually

- Press  button (Set reference mass).
- Enter the reference mass value and press  button to confirm.



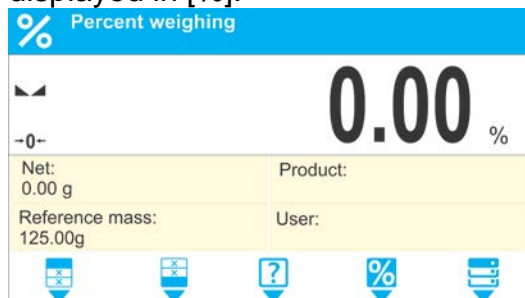

- Weighed products mass is compared to the reference mass, the weight difference is displayed in [%].

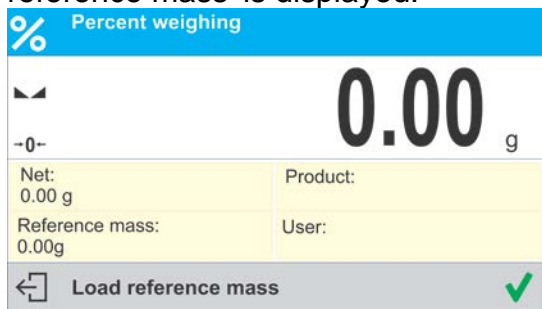

Procedure 2 – accepting mass of load resting on the weighing pan as a reference mass

- Press  button (Determine reference mass (set as 100%)), message 'Load reference mass' is displayed.



- Load the weighing pan with the product to be weighed, wait for a stable indication and press either  or  key.

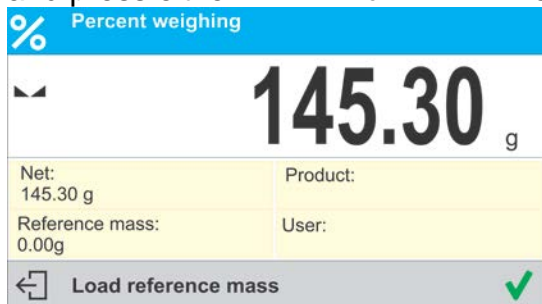

- 100.000% indication is displayed, weight of the product resting on the weighing pan is accepted as reference mass, it is automatically recorded and displayed in reference mass field.

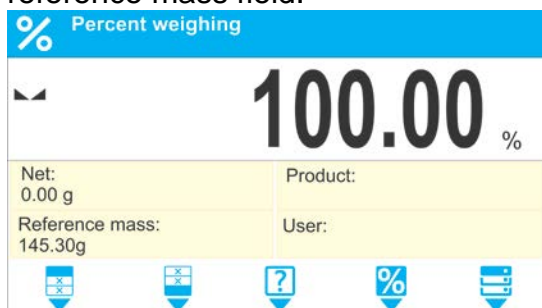

- Unload the weighing pan.
- From now on the weighed products mass is compared to the reference mass, the weight difference is displayed in [%].

Procedure 3 – selecting product from Products Database:

- Press  button (Product); list of products is displayed, select the one that is to be weighed.
- Info field automatically displays modified information concerning reference mass and product mass.

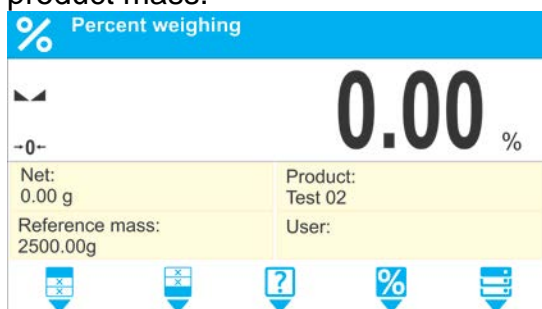

- Product-related reference mass is automatically recorded and displayed in reference mass field.
- 0.000 % indication is displayed (for unloaded pan).
- From now on the weighed products mass is compared to the reference mass, the weight difference is displayed in [%].

22. SOLIDS DENSITY

<Solids density> is a working mode enabling determination of density of a representative sample material.

In order to operate this mode, a density determination kit (supplementary equipment) is required.

Caution: for PM series balances there is no standard density determination kit.

Procedure for activation of Solids Density mode:

- Select <Solids density> mode, the home screen is displayed automatically, wherein the top bar of the screen features  pictogram.

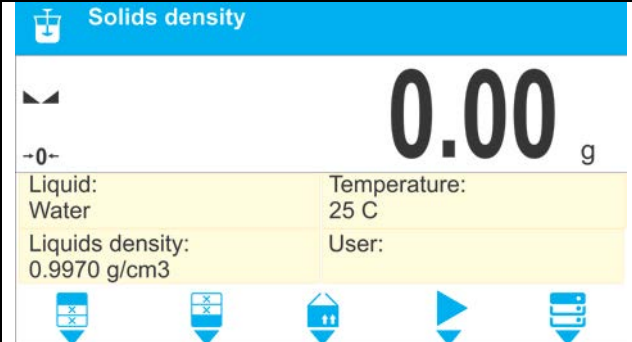
	<p>Info field provides the following information:</p> <ul style="list-style-type: none"> • Liquid • Liquid density • Temperature • Operator • Buttons: print header, print footer, operator, start, databases
--	---

22.1. Mode Related Settings

The supplementary settings enable you to adjust the working mode to your needs and requirements.

Liquid

Parameter allowing to specify liquid used for measurement performance: Water/Ethanol/Other.

Liquid density

Parameter allowing to enter density of liquid used for measurement performance. This parameter is operable only when MISC option for LIQUID parameter has been selected.

Temperature

Parameter allowing to enter temperature of liquid used for measurement performance. Temperature value is necessary in order to take the right liquid density value needed for density calculation. Balance software stores tables with density of water and ethanol in relation to temperature.

For means of operation of the remaining functions read point *11 WEIGHING Mode Settings*.

22.2. Solids Density – Quick Access Keys

Each working mode features automatically displayed set of default keys. The set can be modified by assigning out-of-list quick access keys to the on-screen buttons. Such operation

requires particular permissions level. List of quick access keys it to be found in section 8 of this user manual.

22.3. Solids Density Determination

Prior to the procedure start, it is necessary to set process-related parameters:

- Liquid type
 - o Distilled water
 - o Ethanol
 - o Other liquid with determined density
- Liquid temperature
(required if either distilled water or ethanol is used as liquid for measurement performance)
- Liquid density

The parameter is set automatically, after the temperature has been entered, if either distilled water or ethanol is used as liquid. In the case of using liquid other than distilled water or ethanol, it is necessary to enter its density manually.

The density of solids is calculated using the following formula:



$$\rho = \frac{A}{A-B} \rho_o$$



- ρ - density of a sample
- A - sample mass measured in the air
- B - sample mass measured in liquid
- ρ_o - liquid density

Determination of density for a particular solid consists in weighing the solid in the air first, and in the liquid next. Upon completed procedure the result is displayed automatically.

Procedure:

1. Install density determination kit.
2. Enter <SOLIDS DENSITY> function.
3. Prepare sample that is to be measured.
4. Start the process by pressing  button (Start).
5. Select liquid type intended for the test performance.
6. Enter the liquid temperature (the program displays the most recently operated temperature value).
7. If liquid assigned to MISC parameter is used, enter its density for the entered measurement temperature.

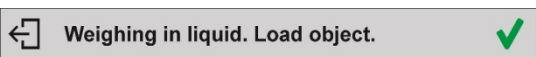
8. The following message is displayed: 
9. Put your sample on a top weighing pan (sample weight measurement carried out in the air), wait for a stable indication and press either  or  key to confirm.

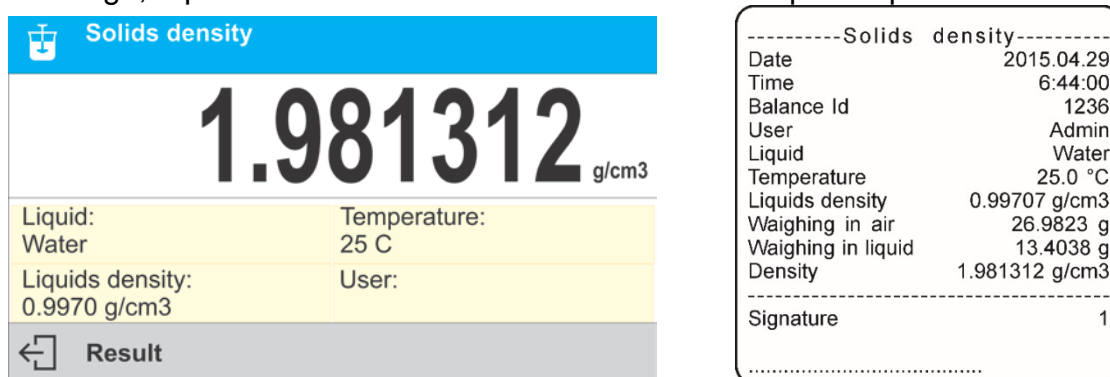

10. The following message is displayed: 
11. Now put your sample on a bottom weighing pan (sample weight measurement carried out in the liquid), wait for a stable indication and press either  or  key to confirm.

12. Upon confirmation of the second indication, the software automatically calculates measured solid density, which is next displayed together with a respective message, report on measurement is sent to a selected printer port.

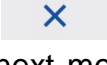

Exemplary report

The report can be printed repeatedly, press either  or  key.

To finish density determination process, press either  or  key. Home screen of the Density Determination mode is displayed. The next measurement can be started now. The balance operates with previously entered settings (liquid, temperature) thus providing quicker start of the measurement.

23. LIQUIDS DENSITY

Liquids density is a working mode enabling determination of density of liquid. In order to operate this mode, a density determination kit (supplementary equipment) is required.

Caution: for PM series balances there is no standard density determination kit. In order to use this function, it is necessary to apply a customized kit.

The density of liquid is calculated using the following formula:

$$\rho = \frac{A - B}{V} + d$$

- ρ - liquid density
- A - sinker mass measured in the air
- B - sinker mass measured in water
- V - sinker volume
- d - air density (max 0.001 g/cm³)

Procedure for activation of Liquids Density mode:

- Select <Liquids density> mode, the home screen is displayed automatically, wherein the top bar of the screen features  pictogram.

<p>Liquids density (with beaker icon)</p> <p>0.00 g</p> <p>-0-</p> <table border="1"> <tr> <td>Sinker volume: 10.000 g/cm³</td> <td>Product:</td> </tr> <tr> <td>Tare: 0.00 g</td> <td>User:</td> </tr> </table> <p>Navigation icons: back, home, stop, play, forward, printer, help.</p>	Sinker volume: 10.000 g/cm ³	Product:	Tare: 0.00 g	User:	<p>Info field provides the following information:</p> <ul style="list-style-type: none"> • Sinker volume • Tare weight • Operator • Buttons: print header, print footer, product, start, databases
Sinker volume: 10.000 g/cm ³	Product:				
Tare: 0.00 g	User:				

23.1. Mode Related Settings

The supplementary settings enable you to adjust the working mode to your needs and requirements.

Sinker volume

Parameter allowing to enter volume of the sinker.

For means of operation of the remaining functions read point 11 *WEIGHING Mode Settings*.







23.2. Liquids Density – Quick Access Keys

Each working mode features automatically displayed set of default keys. The set can be modified by assigning out-of-list quick access keys to the on-screen buttons. Such operation requires particular permissions level. List of quick access keys it to be found in section 8 of this user manual.

23.3. Liquids Density Determination



Glass-made sinker of known volume is a basic equipment used in the course of liquid density determination. Prior to density measurement, enter the sinker volume value into the weighing device memory. Determination of particular liquid density consists in weighing the glass-made sinker in the air first, and in the tested liquid next. Upon completed procedure the result is displayed automatically.

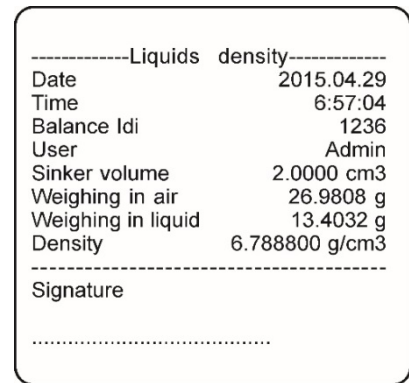
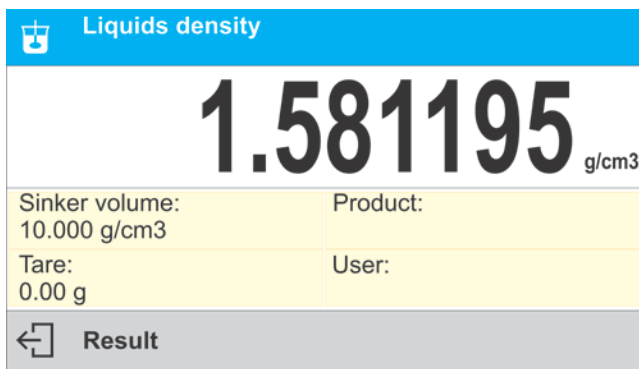

Procedure:

1. Install density determination kit.
2. Enter <LIQUIDS DENSITY> function.
3. Prepare sample that is to be measured (pour tested liquid to the beaker).
4. Start the process by pressing  button (Start).
5. Enter the sinker volume (the program displays volume of the most recently used sinker).
6. The following message is displayed: 
7. Hang the sinker on a stand (sinker weight measurement carried out in the air), wait for a stable indication and press either  or  key to confirm.
8. The following message is displayed: 
9. Now take the sinker out of the stand and put a beaker on the beaker basis (the beaker cannot be in contact with the stand), gently hang the sinker on the stand making sure that it is completely immersed in the liquid (measurement carried out in the liquid), wait for a stable indication and press either  or  key to confirm.
10. Upon confirmation of the second indication, the program automatically calculates measured liquid density, which is next displayed together with a respective message, report on measurement is sent to a selected printer port.



Exemplary report

The report can be printed repeatedly, press either  or  key.

To finish density determination process, press either  or  key. Home screen of the Density Determination mode is displayed. The next measurement can be started now. The balance operates with previously entered settings (sinkers volume) thus providing quicker start of the measurement.

24. ANIMAL WEIGHING

 **Animal weighing** is a working mode allowing reliable determination of mass of weighed objects in motion. In principle, this type of objects generate unstable measurement, thus it requires using a different filtering method of measurement signal.

Procedure for activation of Animal Weighing mode:

- Select <Animal weighing> mode, the home screen is displayed automatically, wherein the top bar of the screen features  pictogram.

	<p>Info field provides the following information:</p> <ul style="list-style-type: none"> • Gross weight • Tare weight • Product • Operator • Buttons: print header, print footer, product, operator, databases
--	--

24.1. Mode Related Settings

The supplementary settings enable you to adjust the working mode to your needs and requirements.

Averaging time

Time interval within which measurements are analysed. Obtained data is used for calculation of measurement result. The result is given in [s].

Autostart

Parameter determining whether the measurement is to be carried out manually (on pressing  key), or automatically.

- YES: operation performed automatically,
- NO: operation performed manually.

Operation performed automatically

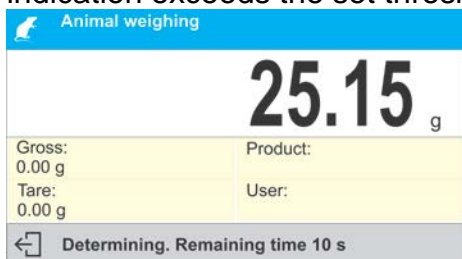

The object is measured automatically when put on a weighing pan and when the indication exceeds the set threshold value (respective message is displayed).

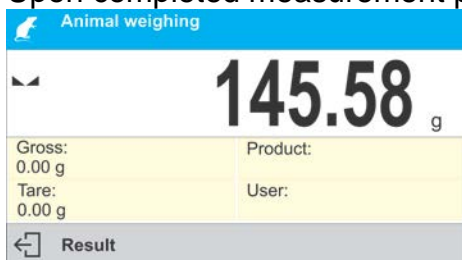

Upon completed measurement procedure, message 'Result' is displayed:



Measurement of the next object can be carried out upon unloading the weighing pan

and pressing either  or  key. Now the weighing pan can be loaded with a new object. The next measurement starts when the set threshold value is exceeded.

Auto threshold

Value expressed in mass units. In order to trigger the measurement, the indicated value has to be greater than the threshold value.

For means of operation of the remaining functions read point *11 WEIGHING Mode Settings*.

24.2. Animal Weighing – Quick Access Keys

Each working mode features automatically displayed set of default keys. The set can be modified by assigning out-of-list quick access keys to the on-screen buttons. Such operation requires particular permissions level. List of quick access keys it to be found in section 8 of this user manual.

Procedure:

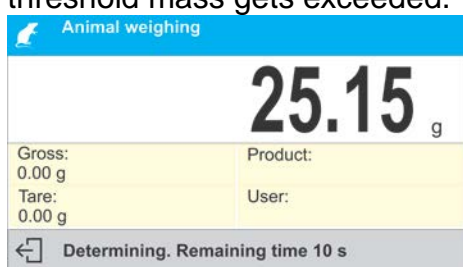

1. Set the function parameters (averaging time, autostart, auto thres.).
2. Load the object that is to be weighed onto the weighing pan, press  button, for automatic operation, mass determination process starts when the set auto threshold mass gets exceeded.

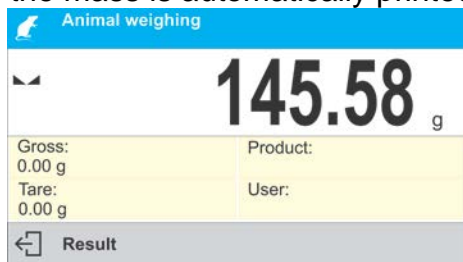

3. Upon completed mass determination process, „freezed” weighing result is displayed, the mass is automatically printed.



The weighing result can be printed repeatedly, press either  or  key.

4. The next measurement can be carried out when either  or  key is pressed:

- for manual operation press  button,
- for automatic operation first unload the weighing pan, next load it with a new object.

25. STATISTICS

 **Statistics** is a working mode allowing to acquire data from series of measurements and to produce statistics using the acquired data. Settings of this function determine which data is displayed.

Procedure for activation of Statistics mode:

- Select <Statistics> mode, the home screen is displayed automatically, wherein the top bar of the screen features  pictogram.

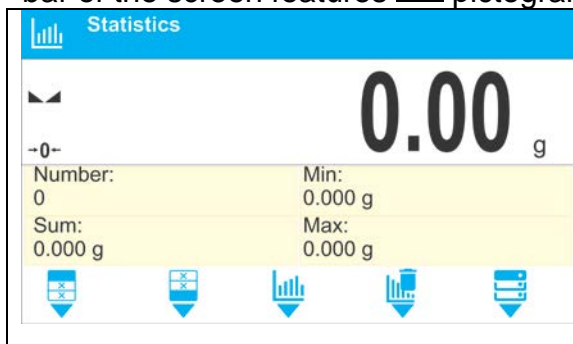

Info field provides the following information:

- Number (samples quantity)
- Sum (total weight of samples within a series)
- Min (minimum value in a series)
- Max (maximum value in a series)
- Buttons: print header, print footer, results, finish, databases

25.1. Mode Related Settings

The supplementary settings enable you to adjust the working mode to your needs and requirements.

For means of operation of these functions read point 11 *WEIGHING Mode Settings*.

25.2. Statistics – Quick Access Keys

Each working mode features automatically displayed set of default keys. The set can be modified by assigning out-of-list quick access keys to the on-screen buttons. Such operation requires particular permissions level. List of quick access keys it to be found in section 8 of this user manual.

25.3. Measurement Series Parameters

For each series of measurements it is possible to overview the results, print a report, delete results of all statistics.

Procedure 1:



1. Press button (Results).

Results	
Number	9
Sum	455.600 g
Average	50.6222 g
Min	49.939 g

2. Results of performed measurements are displayed, bottom bar features delete and print buttons (providing that keyboard function has been changed to Fn value).

3. Press:

-  - to print a report,

----- Statistics -----		
Number		9
Sum	455.600 g	
Average	50.6222 g	
Min	49.939 g	
Max	51.380 g	
Różnica	1.441 g	
SDV	0.39605 g	
RDV	0.78 %	

-  - to delete all statistics data.

Procedure 2:



Press button (Finish). Statistics data is printed and deleted automatically.

26. PEAK HOLD

Peak Hold is a working mode allowing you to snap value of maximum force applied to the weighing pan during one loading.

Apart from standard settings for this mode (described in the weighing mode section), additional parameter has been introduced, it sets threshold value determining function activation.

Procedure for activation of Peak Hold mode:

- Select <Peak Hold> mode, the home screen is displayed automatically, wherein the top bar of the screen features  pictogram.

Peak hold	Info field provides the following information: <ul style="list-style-type: none"> Net weight Threshold Gross weight Operator Buttons: print header, print footer, product, delete, databases 				
0.00 g					
<table style="width: 100%; border-collapse: collapse;"> <tr> <td style="width: 50%; border-right: 1px solid black;">Net: 0.00 g</td> <td style="width: 50%;">Threshold: 1.00 g</td> </tr> <tr> <td style="border-right: 1px solid black;">Gross: 0.00 g</td> <td>User:</td> </tr> </table>		Net: 0.00 g	Threshold: 1.00 g	Gross: 0.00 g	User:
Net: 0.00 g		Threshold: 1.00 g			
Gross: 0.00 g	User:				

26.1. Mode Related Settings

The supplementary settings enable you to adjust the working mode to your needs and requirements.

- THRESHOLD** – function determining start point for peak hold control performed by the balance software. Remember to set this threshold prior to the measuring process.

For means of operation of the remaining functions read point 11 *WEIGHING Mode Settings*.

26.2. Peak Hold – Quick Access Keys

Each working mode features automatically displayed set of default keys. The set can be modified by assigning out-of-list quick access keys to the on-screen buttons. Such operation requires particular permissions level. List of quick access keys it to be found in section 8 of this user manual.

26.3. Means of Operation

- Enter <PEAK HOLD> mode.
Once you select the mode, the function is active. In order to provide proper operation, set the threshold (in grams) determining point beyond which the function starts to register maximum force applied.
- From now on the balance registers and holds every single weighting which is above the threshold, and which is higher than the result of the previous peak hold. If the software detects mass above the threshold, the highest detected indication is held on the main display and the pictogram <Max> is shown on the right over the measuring unit:

Peak hold				
125.25 ^{Max} g				
<table style="width: 100%; border-collapse: collapse;"> <tr> <td style="width: 50%; border-right: 1px solid black;">Net: 0.00 g</td> <td style="width: 50%;">Threshold: 1.00 g</td> </tr> <tr> <td style="border-right: 1px solid black;">Gross: 0.00 g</td> <td>User:</td> </tr> </table>	Net: 0.00 g	Threshold: 1.00 g	Gross: 0.00 g	User:
Net: 0.00 g	Threshold: 1.00 g			
Gross: 0.00 g	User:			

In order to print the result press button.

The start of the next process of peak hold measurement is possible only after removing the load from the weighing pan and pressing **X** button. This causes returning to the home screen of <Peak Hold> mode. Pictogram <Max> is automatically deleted.

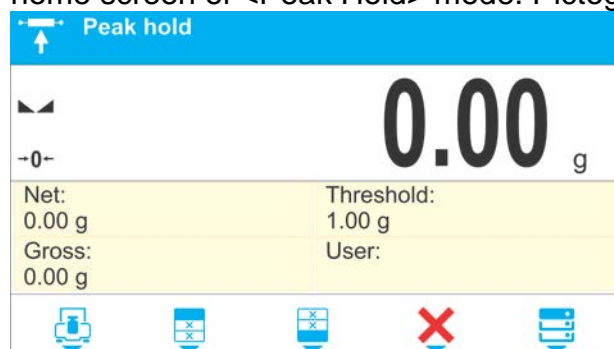

27. FORMULATIONS

Formulations is a working mode allowing you to prepare multi-ingredient mixture. The whole process is carried out automatically. While making mixtures you can:

- **use formulations database** which stores formulations; the program helps you dispense particular amount of formulation ingredients, this is done by means of respective on-screen messages.
- make mixture on your own, without using formulations database, with this option you control dispensed ingredients, their sequence and quantity by yourself.

If you want to use formulations database, first you have to create recipe (make formulation), next apply it. In order to create recipe you have to enter <Formulations Database>. For detailed procedure informing you how to create recipe, read later sections of this user manual.

Procedure for activation of Formulations mode:

- Select <Formulations> mode, the home screen is displayed automatically, wherein the top bar of the screen features  pictogram.

	<p>Info field provides the following information:</p> <ul style="list-style-type: none"> • Bar graph • Formulation • Target value • Sum • Buttons: print header, print footer, formulation, start, databases
--	--

Caution:

Information area may contain bar graph - a graphic interpretation of ingredient weight which informs if the weight stays within correct thresholds and specified +/- tolerance.

27.1. Mode Related Settings

The supplementary settings enable you to adjust the working mode to your needs and requirements.

Multiplier – parameter designed to allow preparation of multiple quantity of particular mixture within one weighing process:

- **YES:** on selecting a formulation for processing, the software asks you to specify multiplier value, each ingredient is next multiplied by this value in the course of weighing, i.e. entered multiplier value is valid for all the ingredients.
- **NO:** entering multiplier value is disabled, by default the value is set to <1>.

27.2. Formulations – Quick Access Keys

Each working mode features automatically displayed set of default keys. The set can be modified by assigning out-of-list quick access keys to the on-screen buttons. Such operation requires particular permissions level. List of quick access keys it to be found in section 8 of this user manual.

27.3. Adding Formulation to Formulations Database

Formulations database menu has been designed to enable adding formulations. You can add up to 100 formulations consisting of 25 ingredients maximum. Formulation database contains formulations names, ingredients names and their weight values. While carrying out formulation you can use a database-recorded product. For each used product enter weight value determining how much of the ingredient is to be added to the mixture, next specify tolerance thresholds for dosing. Weight value and tolerance enable display of bar graph providing information on amount of dosed ingredient (pictograms: Min/Ok/Max).

While adding formulation, first it is necessary to name products required for the formulation. In the course of adding, specify ingredients and their weight values. Particular procedure steps are displayed in a form of prompts.

Make sure you know complete recipe as it is necessary to specify name and weight of each mixture ingredient.

Procedure:

- Enter <Databases> submenu, press  button, next press <Formulations> button.
- Press <Add> button, , do it to add a new formulation.

New record is added and edited automatically. Enter necessary data.

List of parameters defined for a formulation:

1. Name – click Name button, new window opens, go to the window and enter formulation name.

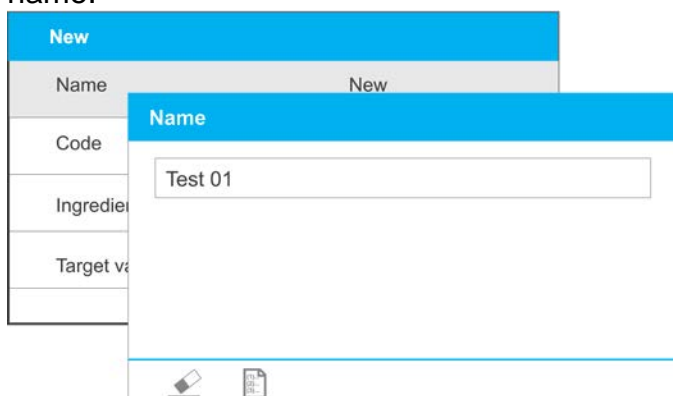

- 2.Code – click code button, new window opens, go to the window and enter code number.
- 3.Ingredients – click ingredients button, list of formulation ingredients is displayed (for new formulation the list is empty), add the ingredients:

- Press <Add> button, +.

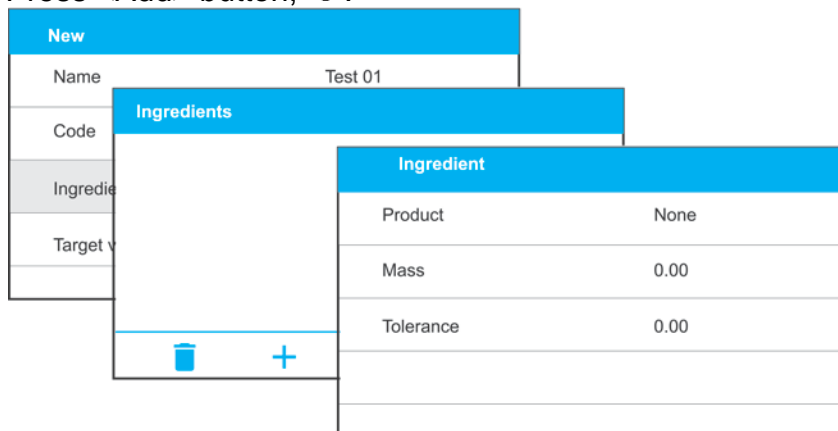

- New record is added and edited automatically. enter respective ingredient data.
- Press X button to go one level up.

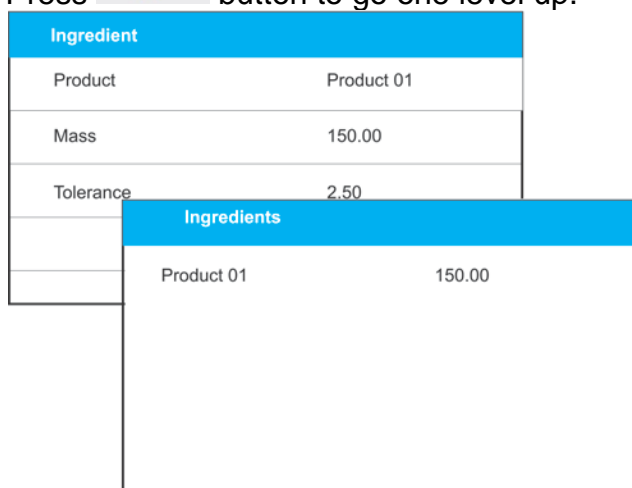

- Enter remaining formulation ingredients.

- 4.Target value – target weight, total mass of all the ingredients, non-editable option, it is updated automatically by the program upon each ingredient adding.

Test 01	
Name	Test 01
Code	
Ingredients	3
Target value	1800.00



Go back to the home screen.

27.4. Using Formulations in the Course of Weighing

Upon running FORMULATIONS mode, you can prepare the mixture either manually or by selecting formulation out of database.

Mixture preparation options:

- formulation not recorded in the Formulation Database – manual preparation,
- formulation recorded in the Formulation Database,
- formulation recorded in the Formulation Database – carried out using multiplier function.

Select a particular formulation, weigh each of its ingredients. Wait for the indication to stabilize, next press  key. Weight of each ingredient is tared upon pressing  > button; i.e. it is accepted for the total mass of the formulation.

Press  button to cancel all operations relating to the formula making process. Now you can prepare a different formulation.

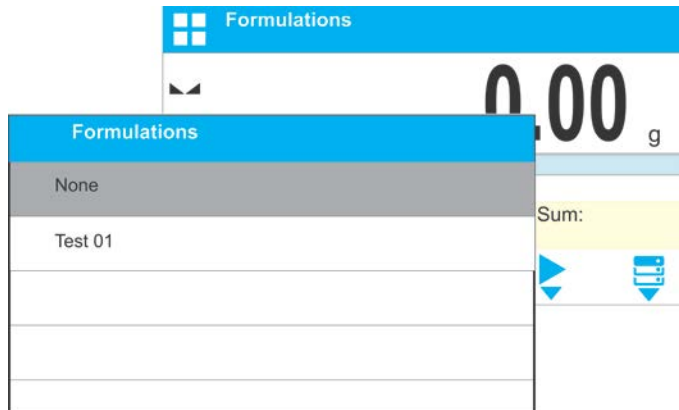

Procedure 1 – formulation not recorded in the Formulation Database – manual preparation. Following the prompts:

- Load the weighing pan with a container intended for the ingredients.
- Go to quick access bar and press  button (Start).
- List of formulations is displayed.
- Press <None> button.



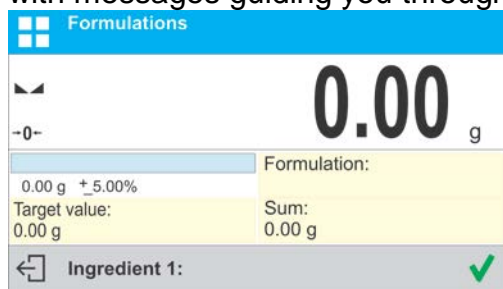

- Home screen is displayed, container weight is tared automatically, navigation bar with messages guiding you through the process is shown.



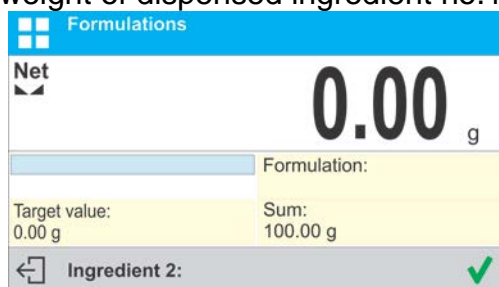

- Dispense specified amount of ingredient no. 1.
- Press either  or  key to confirm.
- 1st ingredient weight is recorded into weighing device memory (Sum field provides weight of dispensed ingredient no.1), the indication gets tared.

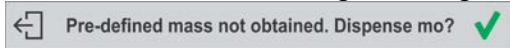

- Repeat the steps for remaining mixture ingredients.
- Having completed dosing, press either  or  key.
- Wait to see the following message:



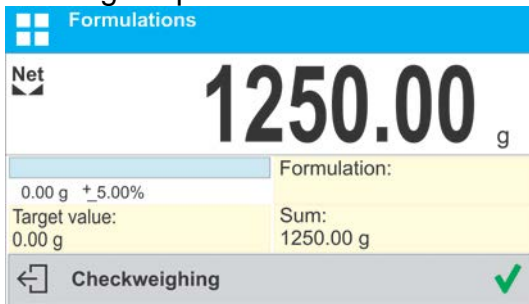

Press either  or  key to boost mixture mass to a specified weight value.

- The main window displays net weight of already weighed ingredients, respective message is provided at the bottom bar:



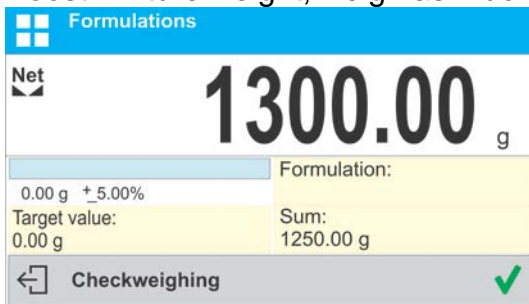

- Boost mixture weight, weigh as much as required to provide specified weight value.





- Press either  or  key to confirm. Mixture dispensing ends, formulation report is printed and recorded in a database (read the next section of this manual to view an example of the report), the following message is displayed:





- To proceed to other operations, press either  or  key.

or:

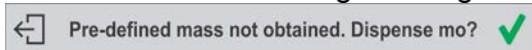

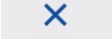
- With the last ingredient dispensed and weighed, press either  or  key.
- Wait to see the following message:





Press either  or  key again in order to resign from boosting mixture weight to a specified value, if there is such a need.

- Wait to see the following message:



- Press either  or  key to confirm. Mixture dispensing ends, formulation report is printed and recorded in a database (read the next section of this manual to view an example of the report), the following message is displayed:



- To proceed to other operations, press either  or  key.

Procedure 2 – formulation recorded in the Formulation Database.
Basic option.

Following the prompts:

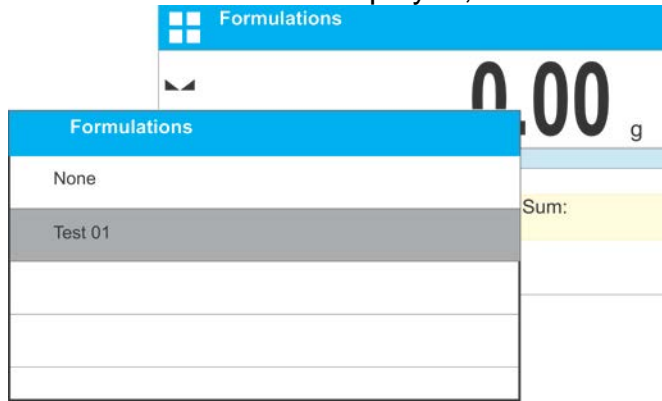

- Load the weighing pan with a container intended for the ingredients.
- Go to quick access bar and press  button (Start).
- List of Formulations is displayed, select the formulation that is to be carried out.

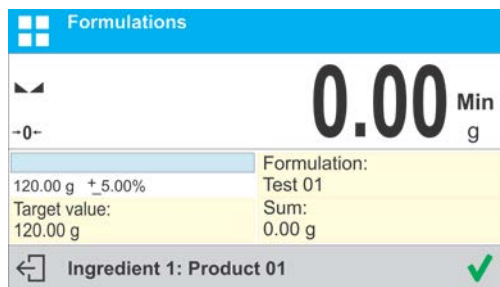

- Home screen is displayed, container weight is tared automatically. <Formulation> field provides formulation name, <Target value> field provides total weight value for a selected formulation, navigation bar with messages for ease of operation and names of particular mixture ingredients.



At the top of information area there is a bar graph, underneath the bar graph weight value that is to be dispensed is displayed. Bar graph colour changes gradually depending on the ingredient weight (read Dosing section for detailed description of bar graph).

- Dispense specified amount of ingredient no. 1.
- Press either  or  key to confirm.
- 1st ingredient weight is recorded into weighing device memory (Sum field provides weight of dispensed ingredient no.1), the indication gets tared.



- Repeat the steps for remaining mixture ingredients.

- When mixture dispensing gets completed, formulation report is printed and recorded in a database (read the next section of this manual to view an example of the report), the following message is displayed:



- To proceed to other operations, press either or key.
- To abort formulation process, press either or key.

Procedure 3 – formulation recorded in the Formulation Database, carried out using <MULTIPLIER> function.

Go to Formulations mode settings and set <Multiplier> parameter to <YES> value, next follow the below procedure.

Procedure:

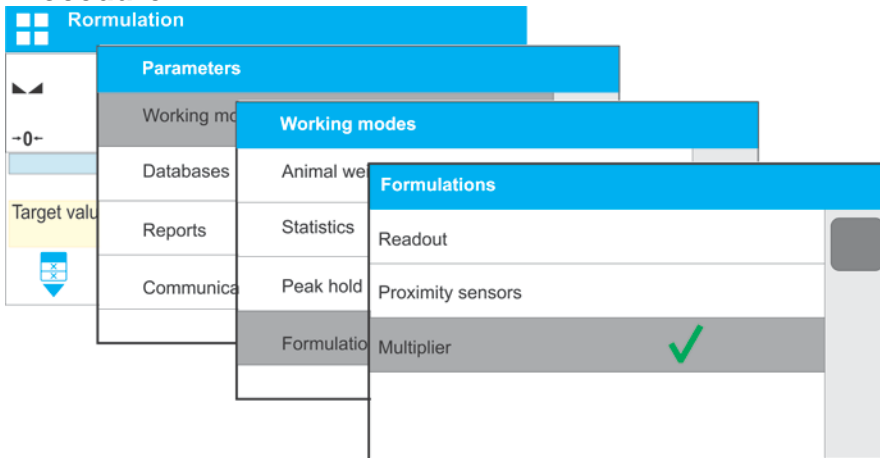

With <YES> value selected, the program asks you to specify multiplier value prior to each process start.

Following the prompts:

- Load the weighing pan with a container intended for the ingredients.
- Go to quick access bar and press button (Start).
- List of Formulations is displayed, select the formulation that is to be carried out.



- Multiplier window with an on-screen numeric keyboard is displayed, use it to enter the multiplier value.

Multiplier

1.20

- Home screen is displayed, container weight gets tared automatically. <Formulation> field provides formulation name, <Target value> field provides total weight value for a selected formulation, which total weight value is multiplied by the entered multiplier; navigation bar features messages guiding you through the process, and names of particular mixture ingredients.

Formulations

0.00 Min g

144.00 g ±3.00%	Formulation: Test 01
Target value: 144.00 g	Sum: 120.00 g

Ingredient 1: Product 01 ✓

Weight of ingredient in bar graph area is also multiplied by the multiplier.

- Remaining steps are identical like in the case of regular formulation carried out without using <MULTIPLIER> function.

27.5. Performed Formulations Report

Upon each completed formulation process the program generates a report. The report is recorded in <Formulation reports> database. Report file name contains date and time of particular process performance.

Report example:

<i>----- Formulation Report -----</i>	
<i>Operator</i>	<i>Nowak Jan</i>
<i>Formulation name</i>	<i>Test 1</i>
<i>Start date</i>	<i>2015.07.10 13:21:40</i>
<i>End date</i>	<i>2015.07.10 13:22:28</i>
<i>Ingredients quantity</i>	<i>5</i>
<i>Measurements quantity</i>	<i>5</i>
<i>----- Ingredient 1 -----</i>	
<i>Name</i>	<i>Product 01</i>
<i>Mass</i>	<i>19.99 g</i>
<i>----- Ingredient 2 -----</i>	
<i>Name</i>	<i>Product 02</i>
<i>Mass</i>	<i>49.99 g</i>
<i>----- Ingredient 3 -----</i>	
<i>Name</i>	<i>Product 03</i>
<i>Mass</i>	<i>9.99 g</i>
<i>----- Ingredient 4 -----</i>	
<i>Name</i>	<i>Product 04</i>
<i>Mass</i>	<i>1.00 g</i>
<i>----- Ingredient 5 -----</i>	
<i>Name</i>	<i>Product 05</i>
<i>Mass</i>	<i>19.99 g</i>
<i>Sum</i>	<i>100.96 g</i>
<i>Target value</i>	<i>101.000 g</i>
<i>Difference</i>	<i>-0.04 g</i>
<i>Status</i>	<i>Completed</i>
<i>-----</i>	
<i>Signature</i>	
<i>.....</i>	

28. BASIC TOTALIZING

Basic Totalizing is a working mode allowing you to sum net weights of measured samples.

This function enables adding maximum 9999 ingredients in one cycle or such quantity of samples for which the total weight value is short enough to be displayed on 8-segment display.

Procedure for activation of Basic Totalizing mode:

- Select <Basic totalizing> mode, the home screen is displayed automatically, wherein the top bar of the screen features Σ pictogram.

	<p>Info field provides the following information:</p> <ul style="list-style-type: none"> • Number (samples quantity) • Sum (total weight of samples within a series) • Product • Operator • Buttons: print header, print footer, results, product, databases
--	--

28.1. Mode Related Settings

The supplementary settings enable you to adjust the working mode to your needs and requirements.

For means of operation of these functions read point 11 *WEIGHING Mode Settings*.

28.2. Basic Totalizing – Quick Access Keys

Each working mode features automatically displayed set of default keys. The set can be modified by assigning out-of-list quick access keys to the on-screen buttons. Such operation requires particular permissions level. List of quick access keys it to be found in section 8 of this user manual.

28.3. Procedure

- Enter <BASIC TOTALIZING> mode. The main window displays data concerning ingredients quantity and total weight value (sum of all ingredients weight).
- Load the weighing pan with the first sample. Wait for a stable indication and press





key to confirm. Sample mass is saved and as a result data on ingredients quantity and total sum, displayed in the bottom line, changes. Data on saved measurement is printed.

1. Net	38.00 g
Tare	0.000 g
Gross	38.00 g

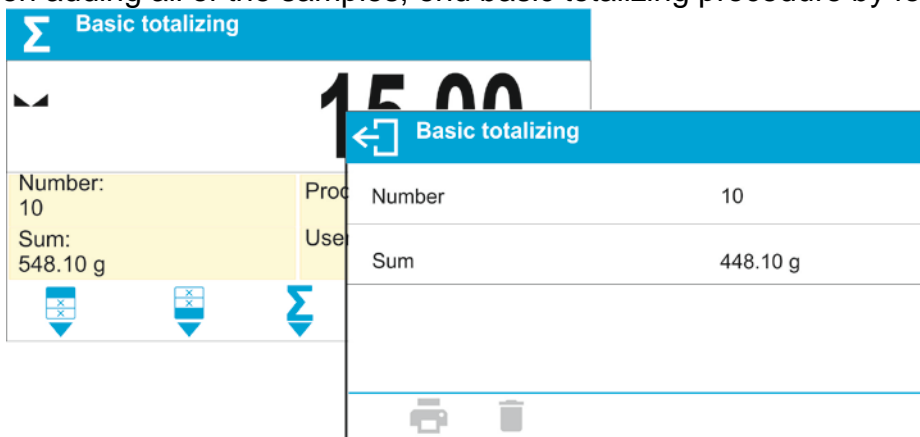

- Next, take off the first sample and load the weighing pan with the second one. Wait for a stable indication and press  key to confirm.
- Add the remaining samples of the measurement series.

Upon adding all of the samples, end basic totalizing procedure by following the below steps:



Press  button, results of performed measurements are displayed, bottom bar features delete and print buttons.

Press:

-  - to print total weight value (the results do not get deleted), you can continue adding, to do it go back to the home screen
-  - to print total weight value and to delete measurement series.

Printout example:

1. Netto	38.000 g
Tara	0.000 g
Brutto	38.000 g
.	
.	
10. Netto	15.000 g
Tara	0.000 g
Brutto	15.000 g
-----Dodawanie-----	
Suma	548.100 g

CAUTION: Upon basic totalizing process completion, only a summary is printed. The masses of particular samples are printed on confirmation.

If the samples are measured with packaging, load the weighing pan with the packaging, wait for a stable indication and press $\rightarrow T \leftarrow$ button.

CAUTION: In the case of BASIC TOTALIZING mode, upon pressing  button (which is done to confirm sample weight), measurement data gets printed. You can print the following data: **Measurement number**, **NET mass** (in calibration unit), **TARE mass** (in current unit), **GROSS mass** (in current unit), and **current result** (in current unit). Data to be printed is to be set in GLP PRINTOUT parameter - see point 15.2 of this user manual. Misc data (apart from the above-listed) such as: USER, PRODUCT, DATE, TIME, VARIABLE 1, VARIABLE 2, CALIBRATION REPORT, NON-STANDARD PRINTOUT are not printed for BASIC TOTALIZING mode.

29. DATABASES

Weighing device software comprises the following databases :

- Products (5 000 records)
- Operators (100 records)
- Packaging (100 records)
- Customers (1 000 records)
- Formulations (100 records, maximum 25 ingredients per formulation)

29.1. Database Connected Operations

The program enables the following operations to be carried out: adding new record, exporting data from databases, importing data to databases, deleting one record from the database, deleting all records from database, printing record data. Access to the above operations is conditioned by permissions levels.

29.1.1. Adding a New Record

Procedure:

- Enter a database and press  button (Add).
- Define fields for the new record (data type is conditioned by a database).
- Database window is displayed, it features newly added record.

29.1.2. Export

Procedure:

- Connect the USB flash drive.
- Enter the database that is to be exported.
- Press  button.
- The program automatically saves exported data to a USB flash drive file, respective messages are displayed for confirmation of successfully completed operation.
- The file name is correlated with the name of exported database.

Databases	File name and extension
Operators Database	Users.ldb32
Products database	Products.ldb32
Packaging database	Packages.ldb32
Customers database	Customers.ldb32
Formulations database	Formulas.ldb32
Non-standard printouts	Non-standard printouts.ldb32
Universal variables	Universal variables.ldb32

CAUTION: In order to export databases, go to *IMPORT/EXPORT* submenu. *IMPORT/EXPORT* submenu is activated upon connecting the USB flash drive to the indicator.

29.1.3. Import

Procedure:



- Save the file with database that is to be imported to a USB flash drive. Only files exported from other balance that have proper names and extensions can be imported – see the above table.
- Connect the USB flash drive.
- Enter the database that is to be imported.

- Press  button.
- The program automatically reads the file and the data is imported to the balance. Respective prompts are displayed for confirmation of successfully completed operation.

CAUTION: In order to import databases, go to *IMPORT/EXPORT* submenu. *IMPORT/EXPORT* submenu is activated upon connecting the USB flash drive to the indicator.



29.1.4. Delete a Record

Procedure:

- Select the record that is to be deleted.
- Press  button.
- Message <**Delete record?**> is displayed.
- Press  key.
- The record gets deleted from the list.

29.1.5. Delete a Database

Procedure:

- Enter the database content of which is to be deleted, press  button.
- Message <**Delete all record?**> is displayed.
- Press  key.
- Database content gets deleted.

29.2. Products

Product database stores lists of all products that can be weighed, counted, controlled.

Parameters defined for a product:

1. Name (43 characters maximum)
2. Code [product code - (15 characters maximum)]
3. EAN [EAN code - (15 characters maximum)]
4. Mass [nominal mass/single piece mass]
5. Tare [product tare value, set automatically when the product is selected out of the database]
6. Min [min threshold for product weighing in CHECKWEIGHING mode]
7. Max [max threshold for product weighing in CHECKWEIGHING mode]
8. Tolerance [% value calculated in relation to mass, the parameter determines measuring range for which the measurement is recognized as correct for DOSING mode]

Caution:

Since values of some of the data are adapted to modes' functions, remember to assign products to respective modes, e.g. mass in <Percent Weighing> mode is accepted as reference mass, whereas mass in <Parts Counting> mode is accepted as single part mass. When a particular product is operated in various modes, then its weight (taken from product data) is associated with various mode-related data.

29.3. Operators

Operators database stores list of users allowed to operate the weighing device.

Parameters defined for an operator:

- Name (43 characters maximum)
- Code (15 characters maximum)
- Password (15 characters maximum)
- Permissions level (options: None, Operator, Advanced operator, Administrator)
- Language

29.4. Packaging

Packaging database stores lists of packaging types. Parameters such as name, code and weight value must be specified for each packaging record. When carrying out weighing process, upon selection of particular packaging, a respective tare value is triggered automatically. The tare value is displayed with minus sign.

Parameters defined for packaging:

1. Name (43 characters maximum)
2. Code [internal code facilitating packaging identification (15 characters maximum)]
3. Tare [packaging weight]

29.5. Customers

Customers database stores list of customers for whom the measurements are carried out.

Parameters defined for customers:

1. Name (43 characters maximum)
2. Code [internal code facilitating customer identification (15 characters maximum)]
3. TIN (15 characters maximum)
4. Street (43 characters maximum)
5. Postal code (7 characters maximum)
6. City (43 characters maximum)

29.6. Formulations

Formulations database stores all created recipes. The recipes can be carried out automatically.

List of parameters defined for a formulation:

1. Name (43 characters maximum)
2. Code
3. Ingredients
4. Target value

29.7. Universal variables

Universal variables database comprises universal variables templates. You can assign the templates to function keys. This allows you to easily enter any text/number/letter, that you want to print, to weighing device memory.

Values of 3 universal variables V_1 , V_2 , V_3 , entered to weighing device memory will be saved to weighing record.

List of parameters defined for a universal variable:

- 1.Code (15 characters maximum)
- 2.Name (43 characters maximum)
- 3.Value (universal variable value that is to be printed and/or saved to weighing record; 32 characters maximum).

30. REPORTS

Weighing device software comprises the following reports databases:

- Formulations reports (500 records)
- Weighings (50 000 records)
- Alibi (512 000 records)

FORMULATION, WEIGHINGS and ALIBI REPORTS databases can be imported. Mind that it is impossible to delete ALIBI database. ALIBI database records can only be exported and saved to USB flash drive. Names of files with exported data feature serial number and respective extension (see below table).

Databases	File name and extension
Formulations reports	xxxxxx.for
Weighings	xxxxxx.wei
Alibi	xxxxxx.ali

Where: xxxxxx – weighing device serial number

Files can be read using **ALIBI Reader**, PC software designed by RADWAG. You can download the software from RADWAG website: www.radwag.pl.

30.1. Formulations Reports

Formulation reports provide information about carried out formulations. Each report can be previewed and printed.

Procedure:

- Enter **<Reports>** submenu, select **<Formulations reports>** parameter.
- Select the respective report, if not visible use navigation keys to scroll the reports list down.
- Report name includes date and time, e.g.: 2015.07.12 15:12:15, and report status.

List of formulations reports data:

1. Operator,
2. Formulation,
3. Start date
4. End date
5. Ingredients quantity
6. Measurements quantity
7. Measurements
8. Sum,
9. Target value
10. Difference

11. Status

30.2. Ambient Conditions

Ambient conditions reports database provide information about various environment-related parameters. Depending on the balance type the ambient conditions report can show values of temperature, humidity, atmospheric pressure. If the given balance is connected to a THB module then its indications are recorded to the database too.

Procedure:

- Enter **<Reports>** submenu, select **<Ambient conditions>** parameter.
- Select the respective record, if not visible scroll the records list down.
- Record name includes data and time.

Ambient conditions	
2017.04.05 14:30:30	
Details	
Date	2017.04.05 14:30:30
Internal sensor: temperature 1	27.5° C
	

Caution: The software saves ambient conditions record in a so called loop, i.e. when the measurement 10 001 is saved, the measurement 1 gets automatically deleted from the balance memory.

Records saved to balance memory cannot be deleted.

30.3. Weighings

Each weighing result sent from the weighing device to a printer is saved to weighings database.

You can preview data of particular weighings.

Procedure:

- Enter **<Reports>** submenu.
- Enter **<Weighings>** database and select respective record.

List of weighing record data:

1. Performed weighing date
2. Performed weighing time
3. Result
4. Mass
5. Tare value
6. Operator
7. Product name
8. Customer, customer name
9. Packaging, name of tare container used in the course of weighing
10. Working mode name

11. Result control, information specifying within which threshold limit the obtained result is comprised:
 - MIN – below min threshold (possible only if <Result control> is set to <NO> value)
 - OK – within min and max threshold
 - MAX – above max threshold (possible only if <Result control> is set to <NO> value)
12. Variable 1
13. Variable 2
14. Variable 3

30.4. Alibi

Each weighing result sent from the weighing device to a printer is saved to Alibi database. You can preview data of particular weighings.

Procedure:

- Enter <Reports> submenu.
- Enter <Alibi> database and select respective record.

List of weighing record data:

1. Performed weighing date
2. Performed weighing time
3. Result (weight value in a current unit)
4. Mass (weight value in adjustment unit)
5. Tare value
6. Operator
7. Product name

31. COMMUNICATION

COMMUNICATION submenu is to be found in Parameters menu. It is accessed by pressing  button. The indicator can communicate with peripheral devices, the communication is established via the following ports:

- COM 1 (RS232),
- COM 2 (RS232),
- USB 1 type A
- USB 2 type B
- Ethernet,
- Wireless communication.

In order to set the ports go to <Communication> submenu.

Press  key, next select „Communication” parameter group.

31.1. RS232 Ports Settings

Procedure:

- Select <COM1> or <COM2> port.
- Set respective transmission parameters.

Transmission parameters for RS 232 ports:

- Baud rate - 2400, 4800, 9600, 19200, 38400, 57600, 115200 bit/s

- Data bits - 7, 8 bits
- Stop bits - 1, 2 bits
- Parity - None, Odd, Even

31.2. ETHERNET Port Settings

Procedure:

- Select <Ethernet> port, set respective transmission parameters:
 - DHCP - Yes / No
 - IP Address - 192.168.0.2
 - Subnet mask - 255.255.255.0
 - Default gateway - 192.168.0.1

Caution: *The above presented values serve informative purposes only. Set the transmission parameters in accordance with your local network.*

Return to weighing procedure and restart the weighing device.

31.3. Wireless Communication Settings

Caution:

1. Set the transmission parameters in accordance with your local network.
2. In order to provide correct communication between the computer and the weighing device via <Wireless communication> port, you must set computer port parameter in your balance to value <Wireless communication>: „PERIPHERALS/COMPUTER/PORT/Wireless communication”. You must also set wireless communication parameters, to do it correctly follow the below procedure.

Balances equipped with wireless communication module display respective pictogram at the top of the screen, provided that the module is active.

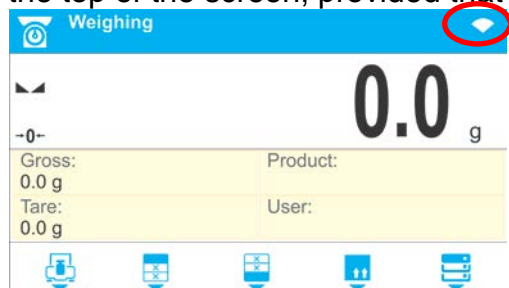

Pictogram for status of wireless communication:

No.	Pictogram	Description
1		The weighing device is connected, very strong signal
2		The weighing device is connected, strong signal
3		The weighing device is connected, poor signal
4		The weighing device is connected, very poor signal
5		No connection (signal too poor, selected network unavailable, connection parameters invalid – password, IP etc.)

Exemplary settings for wireless communication port:

Network configuration	
Scan available networks	
Network name	AAAAA
Password	*****
DHCP	✓
IP Address	10.10.1.109
Subnet mask	255.255.0.0
Default gateway	10.10.254.254

Caution: The above presented values serve informative purposes only. Set the transmission parameters in accordance with your local network.

Procedure:

- Select <Wireless communication> port.

Wireless communication	
Activation	✓
Status	Connected
Network configuration	

- Enter <NETWORK CONFIGURATION> parameter and set DHCP parameter value:

Wireless communication	
Activation	✓
Status	
Network configuration	

Network configuration	
Scan available networks	
Network name	AAAAA
Password	*****
DHCP	✓
IP Address	10.10.1.109

With DHCP set to NO value, enter manually: <IP>; <MASK>; <DEFAULT GATE> parameters.

With DHCP set to YES value, the balance software automatically reads and displays data assigned by Wireless Communication router to which the balance is to be connected.

- Enter <SCANNING NETWORKS> parameter and start network searching procedure. Upon completion, list of detected networks is displayed along with information on signal strength and channel number.

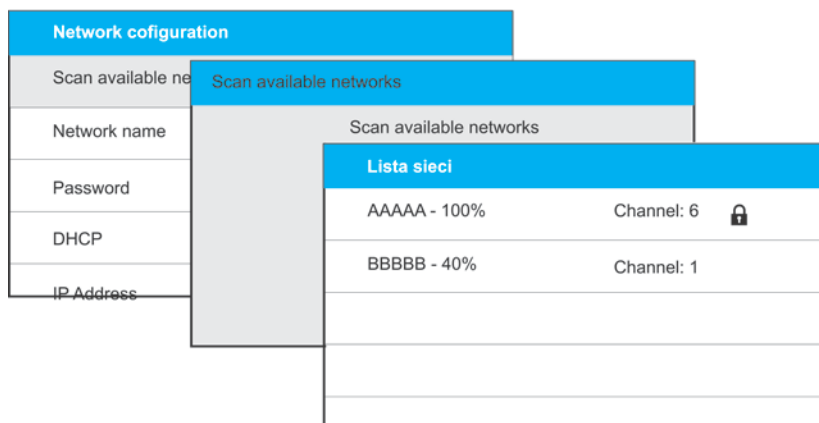

- Select network of your choice.
- Password window is displayed, enter the password using an on-screen keyboard.

Press  key to confirm.

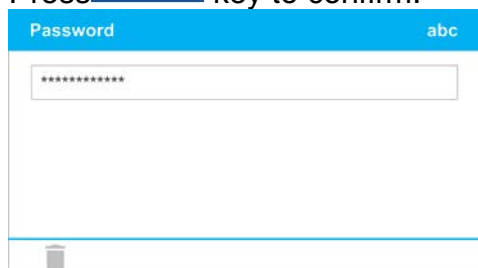

- <NETWORK CONFIGURATION> window is displayed, connection procedure starts automatically.
- Press  key to return to the previous window. <STATUS> parameter features <CONNECTING> sign, operation of connecting the balance to the network is in progress.
- For successfully established connection <CONNECTING> status turns to <CONNECTED> status, respective pictogram is displayed (see pictogram overview above).
- If you are waiting too long for the communication to be established it means that incorrect parameters must have been entered (e.g. password).
- If you fail to establish the communication, contact RADWAG service team.

The selected network and connection parameters are stored by the balance program. The program connects to the network in accordance with the stored parameters each time the balance is switched on.

To disconnect the network turn the communication off:

COMMUNICATION/WIRELESS COMMUNICATION/ACTIVATION – NO 



31.4. USB Ports

USB 1 port of type A is intended for:

- connecting a USB flash drive storing <FAT files system>,
- connecting balance to PCL printer,
- connecting EPSON TM-T20 printer to USB port.

USB flash drive may be used for printing measurements data (set PRINTER/PORT parameter to PENDRIVE value). More detailed information is to be found in section 28 of this user manual. Additionally, databases (for description of this function go to section 28 of this user manual) and user parameters can be copied from balance to balance. Upon inserting USB flash drive, an Export/Import group of parameters opens automatically. If you are authorized you can:

Export: databases, user's parameters

Import: databases, user's parameters

During export the software saves files with databases and parameters content to a flash drive. The exported data can be imported to any C32 series balance.

Please remember that in the case of PCL printer, completely filled page is printed. This means that in order to print the page, it is necessary to press PRINT key, located on the operation panel, for several number of times (printout size determines how many times the PRINT key must be pressed prior to printout).

It is possible to obtain printout upon each pressing of PRINT key, supposing that control code <0C> has been set as SUFFIX (for detailed description of this function read section 31 'Printer').

USB 2 port of type B is intended for:

- connecting balance to a PC.



In order to make connection of balance and computer possible, it is necessary to install virtual COM port in a computer.

To carry out this procedure, you need a respective driver installer which may be either downloaded from the website www.radwag.pl or taken from a CD storing the manuals: *RADWAG USB DRIVER x.x.x.exe*.

Procedure:

1. Run driver installer.

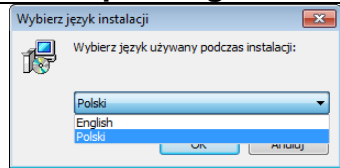
Startup dialogue window:

	<p>Select language version.</p>
	<p>In order to continue, press 'Next' button.</p>

Window for selecting installation path:

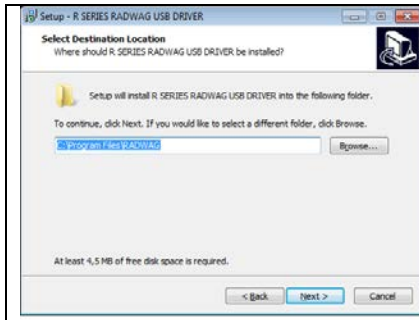

Select a respective folder and click **'Next'** button to proceed.

'Ready to Install' window:

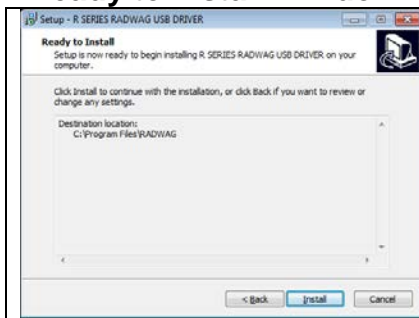

In order to run installation process, press **„Install”** button and clicking respective keys, follow the install wizard.

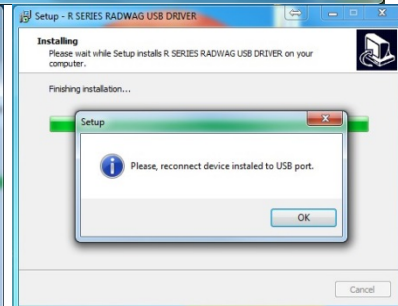
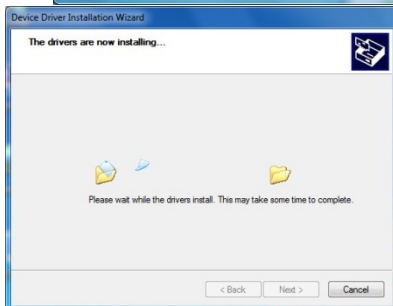
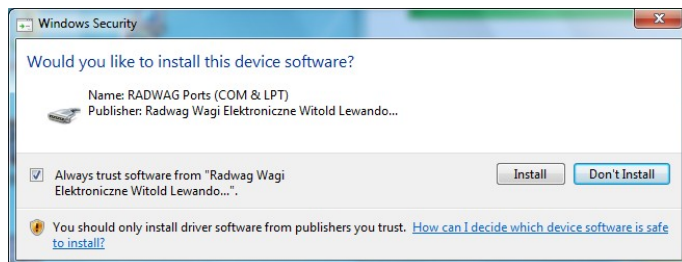

- Having completed driver installation, connect the balance to a computer, use maximum 1.8-meter long USB A/B cable (if the balance is already connected, disconnect it, next reconnect it using USB cable).

3. The system detects the new USB device and automatically starts searching for a respective driver.
4. Go to Device Manager and check number assigned to virtual COM port.

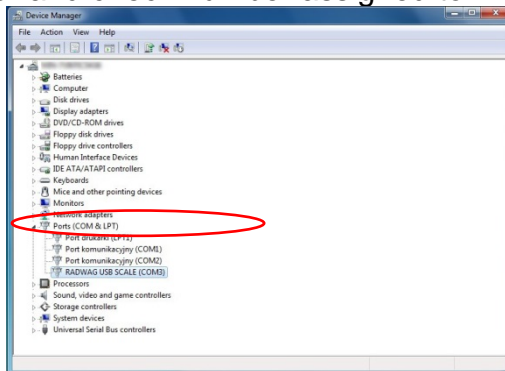

For this very case it is STMicroelectronics Virtual COM Port (COM8).

5. Set balance parameters: select USB B value for COMPUTER/PORT parameter.
6. Run software for measurements readout.
7. Set communication parameters – select COM port that was installed in the course of drivers installation (in this very case it is COM8).
8. Start cooperation.

32. PERIPHERAL DEVICES

PERIPHERALS menu is to be found in Parameters menu. It is accessed by pressing  button. The menu features list of devices that can cooperate with the balance.

32.1. Computer

Carry out configuration using <Computer> submenu.

Procedure:

- Press  button, next press: <Peripherals / Computer>.
- Set parameters related to cooperation with a computer.
- Select computer port:
 - available options: none, COM 1, COM 2, USB B, Ethernet, wireless communication, USB Free Link.

Caution: In order to set USB Free Link instead of USB B, select any other port (e.g. none, COM1, etc.), and next select USB Free Link port. Analogously when changing USB Free Link to USB B.

USB FREE LINK - USB port, type B, for connecting a computer. Tool for entering data, it functions as a keyboard. Upon proper modification of non-standard printout and sending proper command from the computer, or upon pressing ENTER key located on the operation panel, the data from non-standard printout is entered directly to computer programs, e.g. Excel, Word, Notepad etc. Select <USB FREE LINK> port and configure its settings in order to enable correct cooperation of the balance with computer programs:

SPREADSHEET - value YES - cooperation with Excel type program,
- value NO – cooperation with other programs,

DELAY – if the transferred information is incomplete, i.e. part of it gets lost (due to auto-entering or auto-formatting of data by computer program) during cooperation with Excel type program, set the parameter value to <2>. If the transferred information is still incomplete, the parameter value must be higher. The value ranges between 0 (quick data transfer) and 9 (slow data transfer – around 10 characters per second).

In the case of Free Link printout (keyboard emulator) all languages without special characters are operated ('QWERTY' keyboard layout), and two languages that feature special characters:

- Polish for 'Polish (Programmers)' keyboard. To enable support of this language go to printer settings on your balance and select Windows-1250 code page (Central European, Latin-2). The following Polish diacritical signs are added: ą, ć, ę, ł, ń, ó, ś, ź, ż.
- German for 'German (Germany)' keyboard. To enable support of this language, go to printer settings on your balance and select Windows -1252 code page (Western European, Latin-1). The following German diacritical signs are added: ä, ö, ü, ß. The keyboard layout changes from 'QWERTY' to 'QWERTZ'. The characteristic feature of such keyboard is 'ß' sign located on the right side of the 'zero'.

Caution!

Free Link printout option allows printing only signs that are available on a keyboard.

Entering capital letters and special signs, by means of key combination where "Shift" key is pressed, is also possible.

In the case of Polish and German, basic special characters (written using key combination of a given letter and right 'Alt' button) were added.

Free Link printout option does not support printing of remaining special signs.

- Port settings
 - Settings related to a port selected for computer connection.

Caution:

For Ethernet and Wi-Fi® port, Timeout parameter is on. The parameter specifies time delay, i.e. time interval for disconnection, counted from the moment of the most recent command sent from the device to which the balance is connected.

Timeout parameter value has to be entered in milliseconds [ms].

- Address:
 - parameter for setting address of balance connected with a computer.
- Weighing printout template
 - parameter enabling you to design customized printout, for this, use window with printout template. For more information on designing printouts read section 11.2 of this user manual.
- Continuous transmission, parameter enabling to turn on/off continuous transmission of a weighing result, available options:

- continuous transmission in calibration unit, indications are transmitted in the main unit (calibration unit) independently from currently operated unit of mass,
- continuous transmission in current unit, indications are transmitted in a currently operated unit of mass, the transmitted unit changes along with the current unit change (Units key),
- continuous transmission turned off: <NONE>.

Caution: Continuous transmission can be turned on/off by a respective message sent from a computer (read: COMMUNICATION PROTOCOL).

- Interval

Parameter enabling you to set frequency of printouts for continuous transmission.

Frequency of printouts is set in seconds, wherein the accuracy is 0.1s.

Time values range between 1000 and 0.1 s.

The setting is valid for continuous transmission in calibration unit and in current unit activated by means of the balance. It is also valid for continuous transmission activated by a command sent from a computer.



32.2. Printer

Submenu <Printer> enables you to select a port to which data is to be sent upon pressing



key. Content of sent data is set in <PRINTOUTS/GLP PRINTOUTS> parameter.

Procedure:

- Press  key.
- Enter <PERIPHERALS> menu.
- Enter <PRINTER> submenu.
 - set balance parameters related to cooperation with the printer: <PORT> to which the printout is to be sent upon pressing  key (printer connected), available options:

Caution: In order to set USB Free Link instead of USB B, select any other port (e.g. none, COM1, etc.), and next select USB Free Link port. Analogously when changing USB Free Link to USB B.

COM 1 or **COM 2** – RS 232 port, for connecting a printer,

USB A – USB 1 port, type A, for connecting a PCL or EPSON printer,

Ethernet – port for transferring data from balance to a dedicated RADWAG software, e.g. PW-WIN, operated on a computer connected to a balance via network.

PENDRIVE – USB 1 port, type A, for connecting USB flash drive. PENDRIVE option requires setting format for saved file. You can save the data in the following formats:

*.txt format (text file that can be opened on the computer using Notepad), or

*.csv format (file that can be opened using Excel).

Wireless communication – wireless communication port for transferring data from balance to: a dedicated RADWAG software (e.g. PW WIN operated on a computer connected to balance via wireless communication), printer featuring wireless communication port, or network printer.

USB B – USB 2 port, type B, for connecting a computer with a dedicated RADWAG software, e.g. PW-WIN.

USB FREE LINK - USB port, type B, for connecting a computer. Tool for entering data, it functions as a keyboard. Upon proper modification of non-standard printout and sending proper command from the computer, or upon pressing ENTER key located on the operation panel, the data from non-standard printout is directly entered to computer programs, e.g. Excel, Word, Notepad etc.

Select <USB FREE LINK> port and configure its settings in order to enable correct cooperation of the balance with computer programs:

SPREADSHEET - value YES - cooperation with Excel type program,
- value NO – cooperation with other programs,

DELAY – if the transferred information is incomplete, i.e. part of it gets lost (due to auto-entering or auto-formatting of data by computer program) during cooperation with Excel type program, set the parameter value to <2>. If the transferred information is still incomplete, the parameter value must be higher. The value ranges between 0 (quick data transfer) and 9 (slow data transfer – around 10 characters per second).

In the case of Free Link printout (keyboard emulator) all languages without special characters are operated ('QWERTY' keyboard layout), and two languages that feature special characters:

- Polish for 'Polish (Programmers)' keyboard. To enable support of this language go to printer settings on your balance and select Windows-1250 code page (Central European, Latin-2). The following Polish diacritical signs are added: ą, ć, ę, ł, ń, ó, ś, ź, ż.
- German for 'German (Germany)' keyboard. To enable support of this language, go to printer settings on your balance and select Windows -1252 code page (Western European, Latin-1). The following German diacritical signs are added: ä, ö, ü, ß. The keyboard layout changes from 'QWERTY' to 'QWERTZ'. The characteristic feature of such keyboard is 'ß' sign located on the right side of the 'zero'.

Caution!

Free Link printout option allows printing only signs that are available on a keyboard.

Entering capital letters and special signs, by means of key combination where "Shift" key is pressed, is also possible.

In the case of Polish and German, basic special characters (written using key combination of a given letter and right 'Alt' button) were added.

Free Link printout option does not support printing of remaining special signs.

An exemplary measurement printout is described in the PRINTOUTS section.

Additionally you can send a controlling code (of a hexadecimal form) to a printer either at the beginning of the printout - <PREFIX> parameter, or at the end of it - <SUFFIX> parameter. Sending these codes allows to control globally information and actions carried out at the beginning and/or at the end of each printout sent from a weighing device to a printer.

This function is most frequently used:

- to send an information about the code page of a printout sent by a balance, at the beginning, and

- to send a command enabling the crop of a paper in EPSON printers (if the printer is equipped with an auto cutter blade), at the end.

Settings of <Prefix> and <Suffix> parameters are valid for all printouts sent via the weighing device, e.g.: calibration reports, statistics etc., and header, footer and GLP printouts.

Caution:

It must be remembered that inserting paper crop command to <SUFFIX> parameter (control code) results in sending the code after each printout. If you wish for one whole printout to consist of: HEADER, GLP PRINTOUT and FOOTER and to be cropped underneath the FOOTER, then the paper crop command should be inserted only for FOOTER settings as a non-standard printout with <{150}> variable (paper crop for EPSON printer). In such case <SUFFIX> command should stay empty.

To ensure correct cooperation of the balance with the printer (correct printout of diacritical signs of a given language), respective baud rate, obligatory for a given printer, must be chosen (see the printer settings). Additionally code page of a sent printout must be accordant with a code page of a printer.

There are two methods for obtaining code page accordance:

- by setting the right code page in printer settings (read printer's user manual) – it must be accordant with the printout code page of a balance:

Code page	Language
1250	POLISH, CZECH, HUNGARIAN
1251 or 866	RUSSIAN
1252	ENGLISH, GERMAN, FRENCH, SPANISH, ITALIAN
1254	TURKISH
1256	ARABIC

- by sending the control code from the weighing device, which, prior to the printout, automatically sets the right code page of the printer, i.e. code page accordant with the one of a weighing device (Read user manual of the printer you operate to check if it supports this option).

CAUTION: CODES MUST BE ENTERED IN A HEXADECIMAL FORM!

Exemplary balance settings for correct cooperation (printout of Polish signs) with EPSON thermal printer connected to RS232 port:

1. EPSON TM-U220D

Communication parameters for port to which the printer is connected:

- baud rate – 9600 bit/s
- parity – none

Printer parameters set for PERIPHERALS group:

- port – COM 1 or COM 2 (the one to which the printer is connected)
- code page – **852**

2. EPSON TM-T20

Communication parameters for port to which the printer is connected:

- baud rate – 38400 bit/s
- parity – none

Printer parameters set for PERIPHERALS group:

- port – COM 1 or COM 2 (the one to which the printer is connected)
- code page – **1250**
- prefix – **1B742D**

Printer parameters set for PERIPHERALS group:

- port – COM 1 or COM 2 (the one to which the printer is connected)
- code page – **852**

- *prefix* – **1B7412**

If on the printout in the place of the last digit there are any unexpected signs (for verified balances), then <CONTROL CODES> parameter must incorporate, apart from the code page, code of the UK signs chart: **1B5203**. In such case the <CONTROL CODES> parameter is set as follows: *prefix* – **1B74121B5203**

Control codes for exemplary code pages:

Control code	Page or other command	Control code	Page or other command
1B7412	Code page 852	1B7432	Code page 1256
1B742D	Code page 1250	1B7433	Code page 1257
1B742E	Code page 1251	1B5203	UK signs chart
1B7410	Code page 1252	1B5202	DE signs chart
1B7430	Code page 1254	1D564108	Paper crop
1B7411	Code page 866	0C	Form feed (for PCL printers)

32.3. Record of Measurement Data Onto a USB Flash Drive

The balance software enables record of measurement data onto an external flash drive. Procedure:

- Plug a USB flash drive into USB 1 port, type A.
- Enter <PERIPHERALS/PRINTER/PORT> submenu and set <PENDRIVE> value.
- Set file format: *.txt or *.csv
- Return to weighing.
-  key, when pressed, provides record of measurement data (specified for GLP PRINTOUT), wherein the data is saved in a form of a *.txt or *.csv file, created automatically by balance software. The file name is: *printout.txt* or *printout.csv*.
- Remove the USB flash drive from a balance's USB port after about 10s counting from the last measurement record, only after this time the data is saved. Next plug the USB flash drive to a computer and read the saved text file using Notepad or Excel.

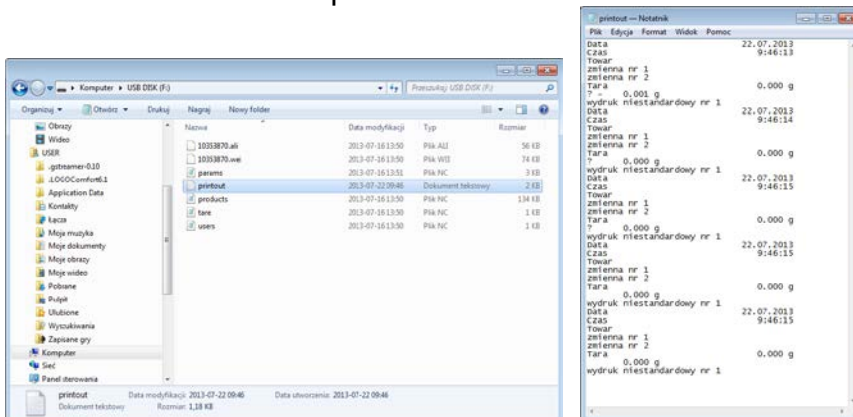

The data can be printed using any printer connected to a computer. New data can be recorded to an existing file therefore you can continue recording measurement data using the file once created.

Caution: USB flash drive must comprise <FAT files system>.

32.4. Barcode Scanner

The balance allows for cooperation with a barcode scanner. The barcode scanner is used to facilitate quick search for database records.

Caution:

Enter **<Communication>** submenu and set baud rate for a barcode scanner (by default 9600b/s). For detailed description of 'balance' - 'barcode scanner' communication read **APPENDIX 01** of this user manual.

32.4.1. Barcode Scanner Port

Communication between the weighing device and the barcode scanner can be established via the following ports: RS232 (1), RS232 (2), USB A.

Procedure:

- Enter **<Peripherals / Barcode Scanner / Port>** submenu and set respective port.

32.4.2. Offset

Parameter allowing you to set the first significant code's character, characters preceding the first significant character are skipped during comparison search.

Procedure:

- Enter **<Peripherals / Barcode Scanner / Offset>** submenu and, using the on-screen keyboard, enter a required value.

32.4.3. Length of Code

Parameter allowing you to set the number of code's characters to be taken into account during search procedure.

Procedure:

- Enter **<Peripherals / Barcode Scanner / Length of code>** submenu and, using the on-screen keyboard, enter a required value.

32.4.4. Prefix, Suffix

Parameter allowing you to edit **<Prefix>** and **<Suffix>** in order to provide synchronization of the balance program with a barcode scanner.

Caution:

*In RADWAG-adopted standard, the prefix is 01 sign (byte) hexadecimal format, the suffix is 0D sign (byte) hexadecimal format. For detailed description of 'balance' - 'barcode scanner' communication read **APPENDIX 01** of this user manual.*

Procedure:

- Enter **<Peripherals / Barcode Scanner / Prefix>** submenu and, using the on-screen keyboard, enter a required value (hexadecimally).
- Go to **<Suffix>** submenu and, using the on-screen keyboard, enter a required value (hexadecimal format).

32.4.5. Field Selection

Parameter allowing you to specify, for which field the search is to be carried out in particular databases.

Procedure:

- Enter **<Peripherals / Barcode Scanner / Field selection>** submenu, list of fields for search is displayed.

Available values: None, Product, Operator, Customer, Packaging, Formulation.

32.4.6. Filtering

Parameter allowing you to declare search criteria.

Procedure:

- Enter **<Peripherals / Barcode Scanner / Filtering>** submenu, list of search criteria is displayed.

Filtering criteria conditioned by field type:

Field selection	Filtering
None	*
Product,	Name, Code.
Operator	Name, Code.
Customer	Name, Code.
Packaging	Name, Code.
Formulation	Name, Code.

*) - **<Filtering>** submenu hidden. Function inactive.

32.4.7. Test

Parameter allowing you to verify if operation of a barcode scanner connected to a balance is correct.

Procedure:

- Enter **<Barcode Scanner / Test>** submenu, **<Test>** edit box is displayed, it features ASCII field and HEX field.
- The code is scanned and entered to the ASCII field and HEX field, next the test result is displayed in the bottom part.

When:

- **<Prefix>** and **<Suffix>** declared in balance settings comply with **<Prefix>** and **<Suffix>** of the scanned code, the test result is **<Positive>**.
- **<Prefix>** and **<Suffix>** declared in balance settings do NOT comply with **<Prefix>** and **<Suffix>** of the scanned code, the test result is **<Negative>**.

32.5. Additional Display

Submenu **<ADDITIONAL DISPLAY>** comprises settings for cooperation with an external additional display WD-6.

Procedure:

- Press  key.
- Enter <PERIPHERALS> menu.
- Enter <ADDITIONAL DISPLAY> submenu.
- Set balance parameters related to cooperation with the additional display;
<PORT> - selection of port for connecting the additional display:
 - available options: NONE, COM 1, COM 2.

Caution:

The balance cooperates with RADWAG additional display.

Ensuring correct cooperation between the weighing device and the additional display requires baud rate parameter value to be set to 115200 bit/s for the port to which the additional display is plugged.

Additional display features text area for extra information such as date, tare value etc. (balance variables). Displayed data content is set using the weighing device.

Procedure:

- Press  key.
- Enter <PERIPHERALS> menu.
- Enter <ADDITIONAL DISPLAY> submenu.
- Enter <BOTTOM TEXT AREA TEMPLATE> parameter, an on-screen keyboard is displayed. Enter respective data.

Using the keyboard write appropriate text, press  key to confirm. The text can consist of 19 characters maximum. If you want to display any variable, enter it following the rules, e.g.: {3} – time. For list of available variables refer to section 13.4.

32.6. Ambient Conditions Module

Ambient Conditions module can be connected to the balance via COM1 or COM2 port, where COM1 connects THB 3/5, and COM 2 connects THB Y. In order to provide correct cooperation enter connected module address and baud rate for the port (port settings) to which the ambient conditions module is connected (the address and baud rate data is to be found on an ambient conditions data plate).

Exemplary settings for ambient conditions module port:

Baud rate – 115200 bit/s; Address – 15.

Peripherals	
Computer	
Printer	
Additional display	
Ambient conditions module	

Ambient conditions module	
Port	COM 2
Port settings	
Address	15

Port settings	
Baud rate	115200
Data bits	8
Stop bits	1
Parity	None

33. AMBIENT CONDITIONS

Parameters group which has been designed to enable you to turn on readout of ambient conditions recorded by the ambient conditions module. Using this submenu, you can also specify tolerance high and low threshold of both temperature and humidity, and a change rate for these values per hour. The entered values are referred to indicted ones. Next on the basis of values comparison respective pictograms are displayed informing you whether the sensor-read values are comprised within permissible limits or not.

Particular sensors settings:

Parameters	
Units	Ambient conditions
Ambient conditions recording interval [min]	30
Misc	Internal sensor: temperature 1
Balance data	Ambient conditions module

- Ambient conditions recording interval [min]: parameter enabling you to specify record frequency of sensor-registered data, and to determine how often the displayed pictograms (providing information on ambient conditions state) are to be refreshed, by default 30 min value is set.
- Internal sensor 1: enter this parameter to specify tolerance temperature values and balance temperature change rate.

Internal sensor: temperature 1		
Min temperature	15° C	Min temperature – min balance temperature, for lower temperature values the thermometer pictogram is red.
Max temperature	35° C	Max temperature – max balance temperature, for higher temperature values the thermometer pictogram is red.
Temperature delta t/h	3° C	Temperature delta t/h – maximum balance temperature change rate, for higher change rate the balance displays blinking red thermometer pictogram.

CAUTION: In order to enable/disable parameter visibility go to service menu.

- Ambient conditions module: parameters group which has been designed to enable you to turn on readout of data recorded by a balance-connected ambient conditions module, and to specify tolerance values for this module.

Ambient conditions module		
Ambient conditions module	Record and alert	Ambient conditions module - parameter specifying module's working mode. Available options: None – readout of ambient condition module's indications turned off; Record – readout and record of indications into module's database turned on; Record and alert – readout and record of indications into module's database turned on, option of display of warnings informing on ambient conditions change turned on (the warnings are displayed on the basis of tolerance high and low thresholds).
Additional THB sensor	✓	Additional temperature sensor – turning on readout of indication of the additional temperature sensor connected to the ambient conditions module.
Min temperature	15° C	Min temperature – minimum temperature value, for lower
Max temperature	35° C	
Temperature delta dt/h	1.5° C	
Min humidity	10 %	
Max humidity	80 %	
Humidity delta %/h	10 %	

	<p>temperature values the thermometer pictogram is red.</p> <p>Max temperature – maximum temperature value, for higher temperature values the thermometer pictogram is red.</p> <p>Temperature delta t/h – maximum temperature change rate, for higher change rate the balance displays blinking red thermometer pictogram.</p> <p>Min humidity – minimum humidity value, for lower humidity values the pictogram is red.</p> <p>Max humidity – maximum humidity value, for higher humidity values the pictogram is red.</p> <p>Humidity delta %/h – maximum humidity change rate, for higher change rate the balance displays blinking red pictogram.</p>
--	---

With all the parameters set, the home screen displays respective pictograms informing on current ambient conditions values and their change.

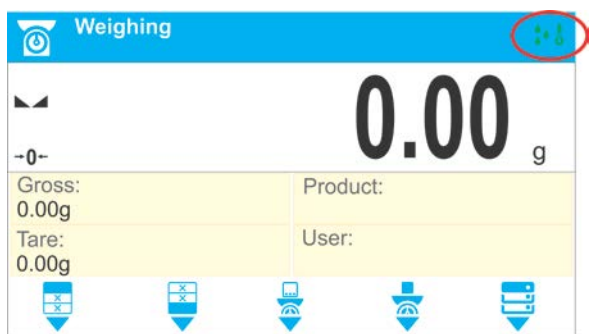

Pictograms for ambient conditions state:

No.	Pictogram	Description
1		Indicated temperature is within specified permissible limits
2		Indicated temperature is out of specified permissible limits
3		Indicated humidity is within specified permissible limits
4		Indicated humidity is out of specified permissible limits
5		Temperature change rate is to high (blinking pictogram)
6		Humidity change rate is to high (blinking pictogram)

34. COMMUNICATION PROTOCOL

General Information

- A. A character based communication protocol (balance-indicator) is designed for establishing communication between a RADWAG balance and a peripheral device.
- B. The protocol consists of commands sent from a peripheral device to the weighing device and responses from the weighing device.
- C. Responses are sent from the weighing device each time a command is received.
- D. Commands, forming the communication protocol, enable obtaining data on weighing device status and facilitate influencing weighing device operation, e.g.: acquiring measurement results from the weighing device, zeroing, etc.

34.1. List of Commands

Command	Command overview
Z	Zero balance
T	Tare balance
OT	Give tare value
UT	Set tare
S	Send stable measurement result in basic measuring unit
SI	Immediately send measurement result in basic measuring unit
SU	Send stable measurement result in current measuring unit
SUI	Immediately send measurement result in current measuring unit
C1	Switch on continuous transmission in basic measuring unit
C0	Switch off continuous transmission in basic measuring unit
CU1	Switch on continuous transmission in current measuring unit
CU0	Switch off continuous transmission in current measuring unit
DH	Set min checkweighing threshold
UH	Set max checkweighing threshold
ODH	Give value of min checkweighing threshold
OUH	Give value of max checkweighing threshold
SM	Set mass value of a single item
TV	Set target mass value
RM	Set reference mass value
NB	Give balance serial number
SS	Value release
IC	Internal adjustment performance
IC1	Disable automatic internal adjustment of the balance
IC0	Enable automatic internal adjustment of the balance
K1	Lock balance keypad
K0	Unlock balance keypad
OMI	Give available working modes
OMS	Set working mode
OMG	Give current working mode

UI	Give accessible units
US	Set unit
UG	Give current unit
BP	Activate sound signal
PC	Send all implemented commands
BN	Give balance type
FS	Give max capacity
RV	Give program version
A	Set AUTOZERO function
EV	Set ambient conditions state
EVG	Give set ambient conditions state
FIS	Set filter
FIG	Give current filter setting
ARS	Set value release
ARG	Give current value release setting
LDS	Set last digit
LOGIN	Operator logging
LOGOUT	Operator logout
PROFILE	Profile selection
PRG	Give set profile name
NT	Cooperation with PUE 7.1, PUE 10 indicator

Caution: Each command must end with CR LF characters.

34.2. Response Format

On receipt of a command, the indicator responds as follows:

XX_A CR LF	command understood and in progress
XX_D CR LF	command carried out (appears only after the XX_A command)
XX_I CR LF	command understood but not accessible at this moment
XX_^ CR LF	command understood but max threshold is exceeded
XX_v CR LF	command understood but min threshold is exceeded
XX_OK CR LF	command carried out
ES_CR LF	command not recognised
XX_E CR LF	time limit exceeded while waiting for stable measurement result (time limit is a characteristic balance parameter)

XX - name of a sent command

_ - space

COMMANDS OVERVIEW

Zero Balance

Format: **Z CR LF**

Response options:

- Z_A CR LF - command understood and in progress
- Z_D CR LF command carried out
- Z_A CR LF - command understood and in progress
- Z_^ CR LF command understood but zeroing range is exceeded
- Z_A CR LF - command understood and in progress
- Z_E CR LF time limit exceeded while waiting for stable measurement result
- Z_I CR LF - command understood but not accessible at this moment

Tare Balance

Format: **T CR LF**

Response options:

- T_A CR LF - command understood and in progress
- T_D CR LF command carried out
- T_A CR LF - command understood and in progress
- T_v CR LF command understood but taring range is exceeded
- T_A CR LF - command understood and in progress
- T_E CR LF time limit exceeded while waiting for stable measurement result
- T_I CR LF - command understood but not accessible at this moment

Give Tare Value

Format: **OT CR LF**

Response: **OT_TARE CR LF** - command carried out

Response format:

1	2	3	4-12	13	14	15	16	17	18	19
O	T	space	tare	space	unit			space	CR	LF

Tare - 9 characters, right justification

Unit - 3 characters, left justification

Caution:

Tare value is always given in calibration unit.

Set Tare

Format: **UT_TARE CR LF**, where **TARE** - tare value

Response options:

- UT_OK CR LF - command carried out
- UT_I CR LF - command understood but not accessible at this moment
- ES CR LF - command not recognised (tare format incorrect)

Caution:

Use dot in tare format as decimal point.

Send Stable Measurement Result in Basic Measuring Unit

Format: **S CR LF**

Response options:

- S_A CR LF - command understood and in progress
- S_E CR LF time limit exceeded while waiting for stable measurement result

S_I CR LF - command understood but not accessible at this moment

MASS FRAME - response: mass value in basic measuring unit

Response format:

1	2-3	4	5	6	7-15	16	17	18	19	20	21
S	space	stability marker	space	character	mass	space	unit			CR	LF

Example:

S CR LF - command sent from a computer

S_A CR LF - command understood and in progress

S _ _ _ _ - _ _ _ _ _ 8 . 5 _ g _ _ CR LF - command carried out, response: mass value in basic measuring unit

where: _ - space

Immediately Send Measurement Result in Basic Measuring Unit

Format: **SI CR LF**

Response options:

SI_I CR LF - command understood but not accessible at this moment

MASS FRAME - immediate response: mass value in basic measuring unit

Response format:

1	2	3	4	5	6	7-15	16	17	18	19	20	21
S	I	space	stability marker	space	character	mass	space	unit			CR	LF

Example:

SI CR LF - command sent from a computer

SI _ ? _ _ _ _ _ 1 8 . 5 _ k g _ CR LF - command carried out, immediate response: mass value in basic measuring unit

where: _ - space

Send Stable Measurement Result in Current Measuring Unit

Format: **SU CR LF**

Response options:

SU_A CR LF - command understood and in progress

SU_E CR LF time limit exceeded while waiting for stable measurement result

SU_I CR LF - command understood but not accessible at this moment

MASS FRAME - immediate response: mass value in current measuring unit

Response format:

1	2	3	4	5	6	7-15	16	17	18	19	20	21
S	U	space	stability marker	space	character	mass	space	unit			CR	LF

Example:

SU CR LF - command sent from a computer

SU _ A CR LF - command understood and in progress

SU _ _ _ - _ _ 1 7 2 . 1 3 5 _ N _ _ CR LF - command carried out, response: mass value in current measuring unit.

where: _ - space

Immediately Send Measurement Result in Current Measuring Unit

Format: **SUI CR LF**

Response options:

SUI_I CR LF - command understood but not accessible at this moment

MASS FRAME - command carried out, immediate response: mass value in current measuring unit

Response format:

1	2	3	4	5	6	7-15	16	17	18	19	20	21
S	U	I	stability marker	space	character	mass	space	unit			CR	LF

Example:

SUI CR LF - command sent from a computer

SUI? _ - _ _ _ 5 8 . 2 3 7 _ k g _ CR LF - command carried out, immediate response: mass value in current measuring unit

where: _ - space

Switch on Continuous Transmission in Basic Measuring Unit

Format: **C1 CR LF**

Response options:

C1_I CR LF - command understood but not accessible at this moment

C1_A CR LF - command understood and in progress

MASS FRAME - response: mass value in basic measuring unit

Response format:

1	2	3	4	5	6	7-15	16	17	18	19	20	21
S	I	space	stability marker	space	character	mass	space	unit			CR	LF

Switch off Continuous Transmission in Basic Measuring Unit

Format: **C0 CR LF**

Response options:

C0_I CR LF - command understood but not accessible at this moment

C0_A CR LF - command understood and carried out

Switch on Continuous Transmission in Current Measuring Unit

Format: **CU1 CR LF**

Response options:

CU1_I CR LF - command understood but not accessible at this moment

CU1_A CR LF - command understood and in progress

MASS FRAME - response: mass value in current measuring unit

Response format:

1	2	3	4	5	6	7-15	16	17	18	19	20	21
S	U	I	stability marker	space	character	mass	space	unit			CR	LF

Switch off Continuous Transmission in Current Measuring Unit

Format: **CU0 CR LF**

Response options:

CU0_I CR LF - command understood but not accessible at this moment

CU0_A CR LF - command understood and carried out

Set Min Checkweighing Threshold

Format: **DH_XXXXX CR LF**, where: _ - space , **XXXXX** - mass format

Response options:

DH_OK CR LF - command carried out

ES CR LF - command not recognised (mass format incorrect)

Set Max Checkweighing Threshold

Format: **UH_XXXXX CR LF**, where: _ - space, **XXXXX** - mass format

Response options:

UH_OK CR LF - command carried out

ES CR LF - command not recognised (mass format incorrect)

Give Value of Min Checkweighing Threshold

Format: **ODH CR LF**

Response: **DH_MASS CR LF** - command carried out

Response format:

1	2	3	4-12	13	14	15	16	17	18	19
D	H	space	mass	space	unit			space	CR	LF

Mass - 9 characters, right justification

Unit - 3 characters, left justification

Give Value of Max Checkweighing Threshold

Format: **OUH CR LF**

Response: **UH_MASS CR LF** - command carried out

Response format:

1	2	3	4-12	13	14	15	16	17	18	19
U	H	space	mass	space	unit			space	CR	LF

Mass - 9 characters, right justification

Unit - 3 characters, left justification

Set Mass Value of a Single Item (for PARTS COUNTING mode only)

Format: **SM_XXXXX CR LF**, where: _ - space, **XXXXX** - mass format

Response options:

SM_OK CR LF - command carried out

SM_I CR LF - command understood but not accessible at this moment (e.g. other than PARTS COUNTING mode operated)

ES CR LF - command not recognised (mass format incorrect)

Set Target Mass Value (e.g. DOSING mode)

Format: **TV_XXXXX CR LF**, where: _ - space, **XXXXX** - mass format

Response options:

TV_OK CR LF - command carried out

TV_I CR LF - command understood but not accessible at this moment (e.g. mode other than DOSING)

ES CR LF - command not recognised (mass format incorrect)

Set Reference Mass Value (e.g. for PERCENT WEIGHING)

Format: **RM_XXXXX CR LF**, where: _ - space, **XXXXX** - mass format

Response options:

RM_OK CR LF - command carried out

RM_I CR LF - command understood but not accessible at this moment (e.g. mode other than PERCENT WEIGHING)

ES CR LF - command not recognised (mass format incorrect)

Value Release

Format: **SS CR LF**

Response options:

SS_OK CR LF - command understood and in progress

Command's function is similar to function of PRINT key located on the instrument panel.

Internal Adjustment

Format: **IC CR LF**

Response options:

IC_A CR LF - command understood and in progress

IC_D CR LF - adjustment completed

IC_A CR LF - command understood and in progress

IC_E CR LF - time limit exceeded while waiting for a stable measurement result

IC_I CR LF - command understood but not accessible at this moment

Disable Automatic Internal Adjustment of the Balance

Format: **IC1 CR LF**

Response options:

IC1_I CR LF - command understood but not accessible at this moment

IC1_E CR LF - operation disabled, e.g. for verified balance

IC1_OK CR LF - command carried out

Operation is disabled for verified balances.

For non-verified balances the command disabled internal adjustment until it is enabled via IC0 command or until the balance is turned off. The command does not modify settings specifying adjustment start.

Enable Automatic Internal Adjustment of the Balance

Format: **IC0 CR LF**

Response options:

IC0_I CR LF - command understood but not accessible at this moment

IC0_OK CR LF - command carried out

Operation is disabled for verified balances.

Give Balance Serial Number

Format: **NB CR LF**

Response options:

NB_A_"x" CR LF - command understood, response: serial number

NB_I CR LF - command understood but not accessible at this moment

x - balance serial number (in between inverted commas)

Example:

Command: NB CR LF - return serial number

Response: NB_A_"1234567" - weighing device serial number --"1234567"

Lock Balance Keypad

Format: **K1 CR LF**

Response options:

K1_I CR LF - command understood but not accessible at this moment

K1_OK CR LF - command carried out

Command locks the balance keypad (proximity sensors, touch panel) until the moment of turning the balance off or until sending K0 command.

Unlock Balance Keypad

Format: **K0 CR LF**

Response options:

K0_I CR LF - command understood but not accessible at this moment

K0_OK CR LF - command carried out

Give Available Working Modes

Command overview:

Command returns accessible working modes.

Format: **OMI <CR><LF>**

Response options:

OMI <CR><LF>

n_ "Mode name" <CR><LF>

: - command carried out, response: accessible working modes

n_ "Mode name" <CR><LF>

OK <CR><LF>

OMI_I <CR><LF> - command understood but not accessible at this moment

Mode name – parameter, working mode name, inserted in between inverted comas. The name takes form given on a particular balance display, it is provided in a currently selected language.

n - parameter, decimal value determining working mode number.

n →

- 1 – Weighing
- 2 – Parts Counting
- 3 – Percent Weighing
- 4 – Dosing
- 5 – Formulations
- 6 – Animal Weighing
- 8 – Solids Density
- 9 – Liquids Density
- 10 – Peak Hold
- 12 – Checkweighing
- 13 – Statistics
- 21 – Basic Totalizing

Caution:

Working modes numbering is identical for each kind of balance or scale. The numbers are assigned to working modes names.

Some balances give only the number as a response.

Example 1:

Command:	OMI <CR><LF>	- return accessible working modes
Response:	OMI <CR><LF>	- return accessible working modes,
	2_ " Parts counting" <CR><LF>	mode number + name
	4_ " Dosing" <CR><LF>	

12_” Checkweighing” <CR><LF>

OK <CR><LF>

- command carried out

Set Working Mode

Command overview:

Command sets particular working mode.

Format: **OMS_n** <CR><LF>

Response options:

OMS_OK <CR><LF>

- command carried out

OMS_E <CR><LF>

- error in-course of command execution, no parameter or incorrect format

OMS_I <CR><LF>

- command understood but not accessible at this moment

n - parameter, decimal value determining working mode number. To see detailed description go to OMI command.

Example:

Command: OMS_13<CR><LF> - set STATISTICS mode

Response: OMS_OK<CR><LF> - STATISTICS mode set

Give Current Working Mode

Command overview:

Command returns accessible working modes.

Format: **OMG** <CR><LF>

Response options:

OMG_n_OK <CR><LF>

- command carried out, response: current working mode

OMG_I <CR><LF>

- command understood but not accessible at this moment

n - parameter, decimal value determining working mode number. To see detailed description go to OMI command.

Example:

Command: OMG<CR><LF> - return current working mode

Response: OMG_13_OK<CR><LF> - balance set to STATISTICS mode

Give Accessible Units

Command overview:

Command returns units available for a particular device and for a current working mode.

Format: **UI** <CR><LF>

Response options:

UI_”x₁,x₂, ... x_n”_OK<CR><LF>

- command carried out, returns accessible units

UI_I <CR><LF>

- command understood but not accessible at this moment

X - unit symbols, separated by means of commas.

x → g, mg, ct, lb, oz, ozt, dwt, tlh, tls, tlt, tlc, mom, gr, ti, N, baht, tola, u1, u2

Example:

Command: UI <CR><LF> - return available units

Response: UI_”g, mg, ct”_OK<CR><LF> - response: available units

Set Unit

Command overview:

Command sets current unit for a particular device.

Format: **US_x <CR><LF>**

Response options:

US_x_OK <CR><LF> - command carried out, returns accessible units

US_E <CR><LF> - error in-course of command execution, no parameter or incorrect format

US_I <CR><LF> - command understood but not accessible at this moment

x - parameter, units symbols: g, mg, ct, lb, oz, ozt, dwt, tlh, tls, tlt, tlc, mom, gr, ti, N, baht, tola, msg, u1, u2, next

Caution:

If x=next the command swaps to another available unit on the list (it simulates  button pressing).

Example:

Command: US_mg<CR><LF> - set „mg” unit

Response: US_mg_OK<CR><LF> - „mg” set as a current unit

Give Current Unit

Command overview:

Command returns current unit.

Format: **UG <CR><LF>**

Response options:

UG_x_OK<CR><LF> - command carried out, returns accessible units

UG_I <CR><LF> - command understood but not accessible at this moment

x - parameter, units symbols:

Example:

Command: UG<CR><LF> - return current unit

Response: UG_ct_OK<CR><LF> - currently set unit is „ct”

Activate Sound Signal

Command overview:

Command activates BEEP sound signal for a specified amount of time.

Format: **BP_TIME<CR><LF>**

Response options:

BP_OK <CR><LF> - command carried out, BEEP activated

BP_E” <CR><LF> - no parameter or incorrect format

BP_I <CR><LF> - command understood but not accessible at this moment

TIME - parameter, decimal value specifying how long shall the sound last, parameter given in [ms]. Recommended range <50 ÷ 5000>.

If value greater than the permissible high limit is given, then BEEP sound is operated for the maximum permissible amount of time.

Example:

Command: BP_350<CR><LF> - activate BEEP for 350 ms

Response: BP_OK<CR><LF> - BEEP activated

Caution:

BEEP sound activated via BP command is inhibited if in-course of its activation the sound is activated by means of other device: keypad, touch panel, proximity sensors.

Send All Implemented Commands

Format: **PC CR LF**

Command: **PC CR LF**

- send all implemented commands
- command carried out, the indicator displays all implemented commands.

Response: **PC_A_ "Z,T,S,SI..."**

Give Balance Type

Format: **BN <CR><LF>**

Response options:

BN_A_ "x" <CR><LF> - command understood, response: weighing device type

BN_I <CR><LF> - command understood but not accessible at this moment

x - weighing device type (inserted in between inverted commas), with general balance type in front

Example:

Command: **BN <CR><LF>** - return balance type

Response: **BN_A_ "PM C32"** - balance type - "PM C32"

Give Max Capacity

Format: **FS <CR><LF>**

Response options:

FS_A_ "x" <CR><LF> - command understood, response: Max capacity

FS_I <CR><LF> - command understood but not accessible at this moment

x - Max value of reading units (in between inverted commas)

Example:

Command: **FS <CR><LF>** - return Max capacity

Response: **FS_A_ "10000.00"** - Max capacity: "10000 g"

Give Program Version

Format: **RV <CR><LF>**

Response options:

RV_A_ "x" <CR><LF> - command understood, response: program version

RV_I <CR><LF> - command understood but not accessible at this moment

x - program version (in between inverted commas)

Example:

Command: **RV <CR><LF>** - return program version

Response: **RV_A_ " 1.1.1"** - program version: "1.1.1"

Set AUTOZERO Function

Format: **A_n <CR><LF>**

Response options:

A_OK <CR><LF> - command carried out

A_E <CR><LF> - error in-course of command execution, no parameter or incorrect format

A_I <CR><LF> - command understood but not accessible at this moment

N - parameter, decimal value determining autozero settings:

n → 0 – autozero off

1 – autozero on

Caution: Command changes settings for a current working mode.

Example:

Command: A_1<CR><LF> - turn autozero function on
Response: A_OK<CR><LF> - autozero function is on
AUTOZERO function operates until it is turned off by A 0 command.

Set Ambient Conditions State

Format: EV_n <CR><LF>

Response options:

EV_OK <CR><LF> - command carried out
EV_E <CR><LF> - error in-course of command execution, no parameter or incorrect format
EV_I <CR><LF> - command understood but not accessible at this moment

n - parameter, decimal value determining ambient conditions state

n → 0 – unstable ambient conditions

1 – stable ambient conditions

Caution:

Command changes settings for a current working mode.

Example:

Command: EV_1<CR><LF> - set value 'stable' for ambient conditions option
Response: EV_OK<CR><LF> - set value 'stable' for ambient conditions option
<AMBIENT CONDITIONS> parameter is set to value <STABLE> until command EV 0 swaps it to value <UNSTABLE>.

Give Set Ambient Conditions State

Command overview:

Command gives information about state of currently set ambient conditions.

Format: EVG <CR><LF>

Response options:

EVG_x_OK<CR><LF> - command carried out, response: set ambient conditions state

EVG_I <CR><LF> - command understood but not accessible at this moment

x - parameter, symbol of currently set ambient conditions state

Example:

Command: EVG<CR><LF> - give current ambient conditions state
Response: EVG_0_OK<CR><LF> - current ambient conditions state: unstable

Set Filter

Format: FIS_n <CR><LF>

Response options:

FIS_OK <CR><LF> - command carried out
FIS_E <CR><LF> - error in-course of command execution, no parameter or incorrect format
FIS_I <CR><LF> - command understood but not accessible at this moment

n - parameter, decimal value determining filter number

n → 1 – very fast

2 – fast

3 – average

4 – slow

5 – very slow

Caution:

The numbering is assigned to a particular filter name and it is identical for all balance types.

The command changes settings for a current working mode if, for a particular balance type, filter settings are assigned to the working mode.

Example:

Command: FIS_3<CR><LF> - set average filter

Response: FIS_OK<CR><LF> - average filter set

Give Current Filter Setting

Command overview:

Command gives information about currently set filter.

Format: **FIG <CR><LF>**

Response options:

FIG_x_OK<CR><LF> - command carried out, response: currently set filter

FIG_I <CR><LF> - command understood but not accessible at this moment

x - parameter, symbol of currently set filter

Example:

Command: FIG<CR><LF> - give current filter

Response: FIG_2_OK<CR><LF> - currently set filter: average

Set Value Release

Format: **ARS_n <CR><LF>**

Response options:

ARS_OK <CR><LF> - command carried out

ARS_E <CR><LF> - error in-course of command execution, no parameter or incorrect format

ARS_I <CR><LF> - command understood but not accessible at this moment

n - parameter, decimal value determining value release options

n → 1 – fast

2 – fast + reliable

3 – reliable

Caution:

The numbering is assigned to a particular value release option and it is identical for all balance types.

The command changes settings for a current working mode if, for a particular balance type, value release settings are assigned to the working mode.

Example:

Command: ARS_2<CR><LF> - set value release parameter to fast+reliable option

Response: ARS_OK<CR><LF> - fast+reliable option set

Give Current Value Release Setting

Command overview:

Command gives information about current value release setting.

Format: **ARG <CR><LF>**

Response options:

ARG_x_OK<CR><LF> - command carried out, response: current value release setting

ARG_I <CR><LF> - command understood but not accessible at this moment

x - parameter, symbol of current value release setting

Example:

Command: ARG<CR><LF> - give current value release setting

Response: ARG_2_OK<CR><LF> - current value release setting: fast+reliable

Set Last Digit

Format: **LDS_n <CR><LF>**

Response options:

LDS_OK <CR><LF> - command carried out

LDS_E <CR><LF> - error in-course of command execution, no parameter or incorrect format

LDS_I <CR><LF> - command understood but not accessible at this moment

n - parameter, decimal value determining last digit settings

n → 1 – always

2 – never

3 – when stable

Caution:

The numbering is assigned to a particular last digit option and it is identical for all balance types.

The command changes settings for a current working mode if, for a particular balance type, value release settings are assigned to the working mode.

Example:

Command: LDS_1<CR><LF> - set last digit option to value 'always'

Response: LDS_OK<CR><LF> - 'always' value set

Operator Logging

Format: **LOGIN_Name, Password CR LF** where: _ - space

(enter name and password in a form provided by the balance – lower-case letters and upper-case letters)

Response options:

LOGIN OK CR LF - command understood, new operator logged in

LOGIN ERROR CR LF - command understood, an error in name or password occurred, log in failed

ES CR LF - command not recognized (error in format)

Operator Logout

Format: **LOGOUT CR LF**

Response options:

LOGOUT OK CR LF - command understood, user is logged out

ES CR LF - command not recognized (error in format)

Give Set Profile Name

Format: **PRG CR LF**

Response options:

PRG_A_”x” CR LF - command understood, response: profile name

PRG_I CR LF - command understood but not accessible at this moment

x - profile name (in between inverted commas)

Example:

Command: **PRG** CR LF - give profile name
 Response: **PRG _A_ "Fast"** – profile name – "Fast"

Profile Selection

Format: **PROFILE_Name** CR LF

where: _ - space (enter name in a form provided by the balance – *lower-case letters and upper-case letters, spaces; e.g. Fast; Fast dosing, User, Precision*).

Response options:

- PROFILE OK CR LF - command understood, new profile set
- LOGIN ERROR CR LF - command understood, an error in name, profile setting impossible
- ES CR LF - command not recognized (error in format)

Cooperation with PUE 7.1, PUE 10 indicator

Format: **NT** CR LF

Response options:

ES CR LF - command not recognised (mass format incorrect)

MASS FRAME - response: mass value in basic measuring unit

Response format:

1	2	3	4	5	6	7	8	9-18	19	20-22	23	24-32	33	34-36	37	38	39	40
N	T	space	stability marker	zero marker	range marker	digit marker	space	mass	space	mass unit	space	tare	space	tare unit	space	hidden digits quantity	CR	LF

- NT** - command
- Stability marker** - [space] if stable, [?] if unstable
- Zero marker** - [space] for any value but zero, [Z] for zero value
- Range marker** - marker informing on range within which mass value is comprised: [space] I-range balance, [2] II-range balance, [3] III-range balance
- Digit marker** - [zero] no digit, [1] one digit marker, [2] two digits marker, [3] three digits marker, [4] four digits marker, [5] five digits marker
- Mass** - 10 characters for net mass given in adjustment unit (with dot and a floating "-" sign), right justification
- Mass unit** - 3 characters, left justification
- Tare** - 9 characters with dot - right justification (when floating tare gets turned off automatically then zero value is sent)
- Tare unit** - 3 characters, left justification
- Hidden digits quantity** - Number specifying quantity of hidden digits: [space] when no digits are hidden, [1] when 1 digit is hidden

Example:

NT CR LF - command sent from a computer

NT _ ? _ _ 0 _ _ _ _ - 5 . 1 1 3 _ g _ _ _ _ _ 0 . 0 0 0 _ g _ _ _ 0 CR LF

- command carried out, response: mass value and remaining data

where: _ - space

34.3. Manual Printout / Automatic Printout

PM C32 series balance enables generating manual or automatic printouts.

- Manual printout: upon indication stabilization press  key.
- Automatic printout is generated automatically in accordance with the settings for automatic printout (read section 11).

The content of printout depends on settings of <Standard printout> menu - <GLP Printout> (read section 15).

Mass printout format:

1	2	3	4 -12	13	14	15	16	17	18
stability marker	space	character	mass	space	unit			CR	LF

Stability marker [space] if stable
[?] if unstable
[^] if high limit is out of range
[v] if low limit is out of range

Character [space] for positive values
[-] for negative values

Mass 9 characters with decimal point, right justification

Unit 3 characters, left justification

Example:

----- 1 8 3 2 . 0 _ g _ _ CR LF - a printout generated, with reference to <GLP

printout> settings, from a weighing device upon pressing  key:

Date	NO	Universal variable 3	NO
Time	NO	Net weight	NO
Operator	NO	Tare	NO
Product	NO	Gross weight	NO
Customer	NO	Current result	YES
Packaging	NO	Adjustment report	NO
Universal variable 1	NO	Non-standard printout	NONE
Universal variable 2	NO		

35. PERIPHERAL DEVICES

The weighing instrument can cooperate with the following peripheral devices:

- computer,
- EPSON labeller,
- PCL printer,
- peripheral device operating in ASCII communication protocol.

36. ERROR MESSAGES



Max weighing threshold exceeded
Unload the weighing pan



Min weighing threshold exceeded
Install weighing pan



Zeroing out of range
Press tarring button or restart the balance



Display capacity out of range
Unload the weighing pan



Tarring out of range
Press zeroing button or restart the balance



Start mass out of range
Install weighing pan

37. ADDITIONAL EQUIPMENT

Type	Name
P0151	RS232 cable for EPSON printer
EPSON	Dot/thermal printer
	PCL Printer
SAL	Anti-vibration table for AS and PS series balances
	PC keyboard – USB type

Computer software:

- LABEL EDITOR,
- PW-WIN,
- RAD-KEY.

38. BALANCE DATA

Balance Data menu provides information on balance and balance software. Parameters serve information purposes only.

Parameters list:

1. Balance S/N
2. Balance type
3. Program version
4. Balance program version
5. Product code
6. Settings printout

In order to send balance settings (all parameters) to printer port, select <Settings printout> parameter.

39. APPENDIX 01 - Communication with Barcode Scanner

1. For communication with barcode scanners, RADWAG balances use RS232 interfaces and simplex transmission (one-way direction), without handshaking. For this purpose, use of second line of the cable is sufficient. Used scanners should be equipped with RS232 interface, both hardware and software handshaking must be disabled.
2. Transmission parameters can be set for both weighing devices and scanners. For both devices the following parameters must comply: baud rate, data bits quantity, parity control, stop bits quantity; e.g. 9600,8,N,1 – baud rate 9600 bit/s, data 8-bits, no parity control, 1 stop bit.
3. Barcode scanners can send additional information apart from the expected barcode e.g. symbology (type of barcode). Due to the fact that RADWAG devices and software do not use such information, it is advisable to disable it.
4. Some RADWAG systems can omit unnecessary coded information by using parameters that mark the beginning and the length of the code required to analysis.
5. A special protocol is required in order the code be received by RADWAG equipment. It is required to program an appropriate prefix and suffix. In RADWAG-adopted standard, the prefix is 01 sign (byte) hexadecimal format, the suffix is 0D sign (byte) hexadecimal format.
6. Most barcode scanners allow to enable/disable different symbologies (barcode types).

7. Programming of scanners is performed by reading special barcodes.
8. Scanners marketed together with RADWAG systems are always configured according to the rules above.

Barcode with required prefix and suffix in hexadecimal format	Barcode without required -fixes in ASCII format	Code type
01 30 30 32 31 30 31 32 36 0D	00210126	EAN-8
01 30 31 32 33 34 35 36 37 38 39 0D	0123456789	code 2 of 5
01 43 4F 44 45 20 33 39 20 54 45 53 54 0D	CODE 39 TEST	CODE 39
01 31 31 30 31 32 33 34 35 36 37 38 39 31 0D	1101234567891	EAN-13
01 43 6F 64 65 20 31 32 38 20 54 65 73 74 0D	CODE 128 Test	CODE 128

Manual number:
IMMU-23-13-02-21--EN



RADWAG BALANCES AND SCALES
ADVANCED WEIGHING TECHNOLOGIES

