

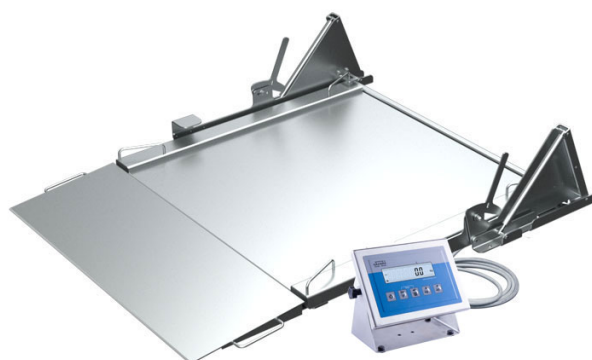



More information on the website
radwag.com/es/info,w1,ZW4

Báscula inoxidable con rampa H315.4N.600.H2.LD





The drawings, photos and graphics used are for illustrative purposes only.

Funciones

 Indicador más/menos

 Desviaciones porcentuales

 Suma de pesajes

 Contar piezas

 Batería interna

 Cierre del pesaje máximo

 Medición en Newtons

 Pesaje de animales

Datos técnicos

Parámetros metrológicos

Maxima capacidad [Max]	600 kg
Minima capacidad	4 kg
Legibilidad [d]	200 g
Rango de tara	-600 kg
Legibilidad máxima para las balanzas no verificadas	50 g
Clase OIML	III

Parámetros físicos

Pantalla	LCD (con retroiluminación)
Dimensión de platillo	1100×1200 mm

Parámetros físicos	
Dimensiones de embalaje	1640×1590×580 mm
Masa neta	175 kg
Masa bruta	300 kg
Longitud del cable	3 m
Construcción	
Grado de protección	IP 68 construcción, IP 68 (1h max)/69 medidor
Interface de comunicación	
Conectividad	RS232, USB
Interfaces opcionales	RS232 o RS485 o 4IN/4OUT o Ethernet o entradas analógica 4-20 mA
Parámetros electricos	
Alimentacion	100 – 240 V AC 50/60 Hz
Corriente de alimentación adicional	batería interna
Horas de trabajo con baterías	max 7h
Condiciones ambientales	
Temperatura de trabajo	-10 ÷ +40 °C
Humedad relativa de aire	10% ÷ 85% RH sin condensación



Extra payment for verification



Accesorios

Cables RS 232 (Bascula a Impresora)
 Pantallas
 Cables de corriente (Bascula a Ethernet)
 Cables RS 232, RS 485
 Convertidor RS 232 a Ethernet
 Adaptadores USB

Impresoras de recibos
 Cable USB (Bascula a Impresora)
 Soportes, brazos
 Convertidor RS 232 a USB
 Cables RS 232, RS 485

Programas

• RAD Key [WX-010-0005]
 • R-LAB [WX-010-0080]

• R Panel [WX-010-0187]
 • Editor de Balanzas 2.1 [WX-010-0173]

Dimensiones de aparato

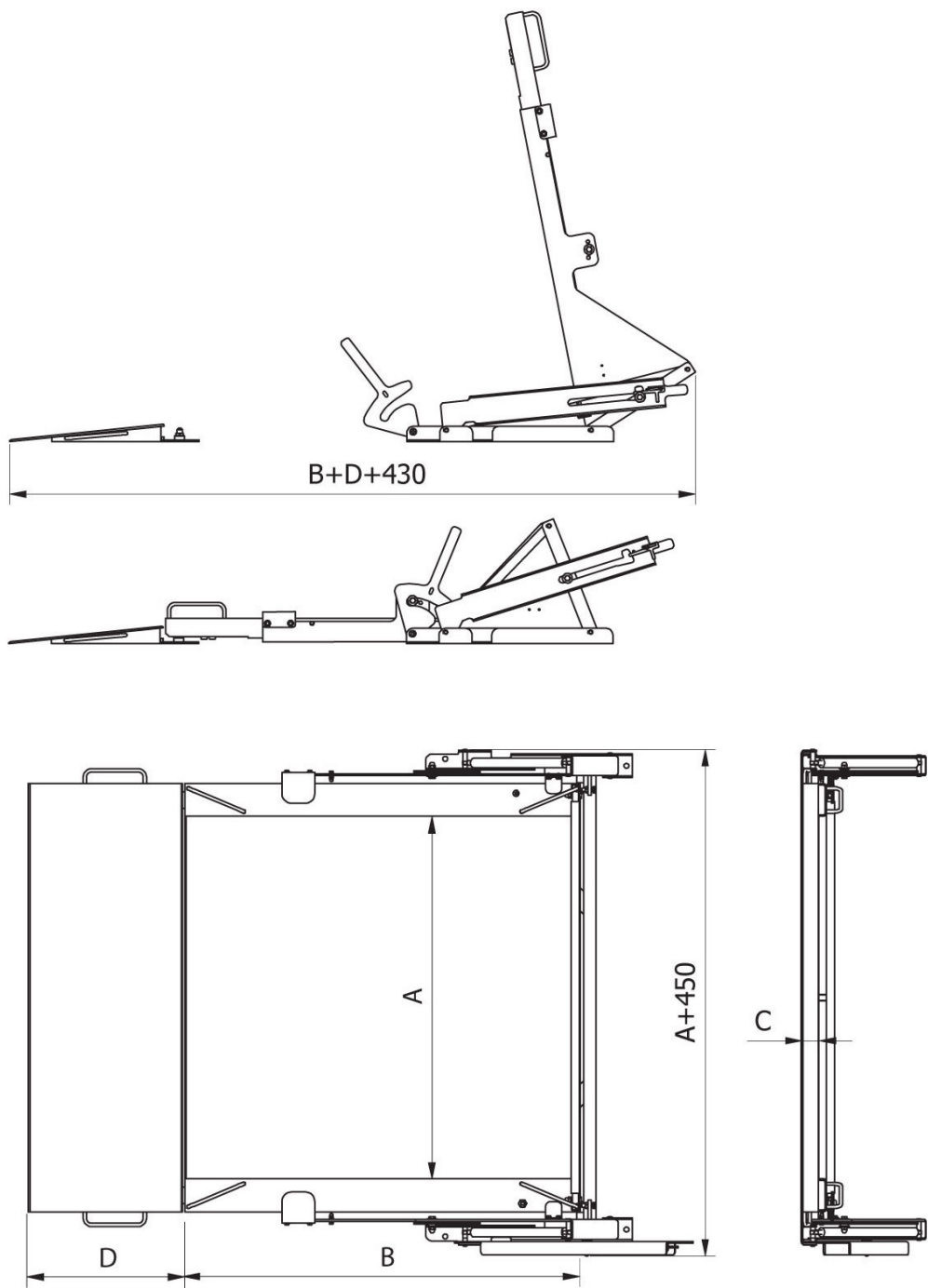

	A [mm]	B [mm]	C [mm]	D [mm]
H315.4N.150.H1.LD	840	860	45	426
H315.4N.300.H1.LD	840	860	45	426
H315.4N.600.H1.LD	840	860	45	426
H315.4N.150.H2.LD	1100	1200	45	426
H315.4N.300.H2.LD	1100	1200	45	426
H315.4N.600.H2.LD	1100	1200	45	426
H315.4N.300.H3.LD	1200	1500	45	426
H315.4N.600.H3.LD	1200	1500	45	426
H315.4N.1500.H2.LD	1100	1200	52	476
H315.4N.1500.H3.LD	1200	1500	52	476
H315.4N.300.H4.LD	1500	1500	52	476
H315.4N.600.H4.LD	1500	1500	52	476
H315.4N.1500.H4.LD	1500	1500	52	476