

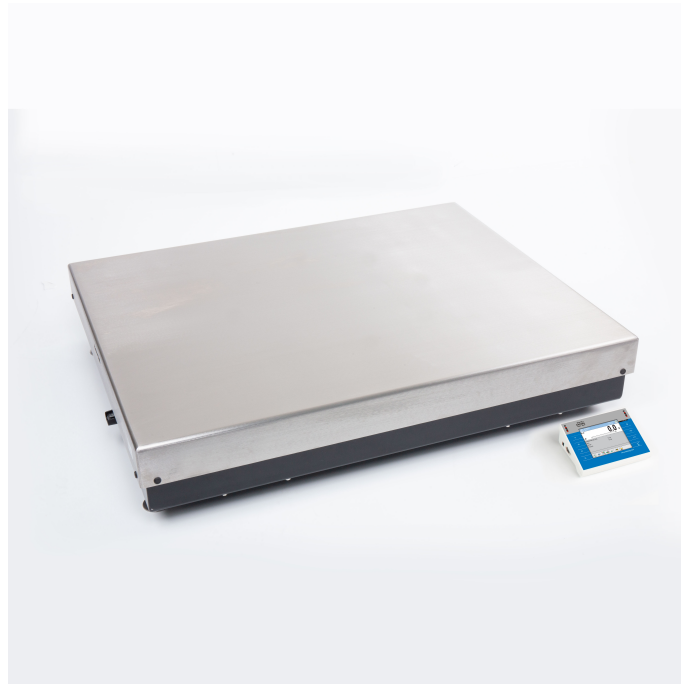

More information on the website
radwag.com/us/info,w1,Z27

PUE 7.1.300.1.HRP.M2.1 High Resolution Scale



The drawings, photos and graphics used are for illustrative purposes only.

Datasheet

Maximum capacity [Max]	300 kg
Minimum load	50 g
Preload range	60 kg
Readability [d]	1 g
Verification unit [e]	10 g
Tare range	-300 kg
Repeatability	3 g
Linearity	±6 g
Stabilization time	3 s
Adjustment	internal (automatic)
OIML Class	II
Maximum quantity of verification units	30000 e
Physical parameters	
Display	5,7" Resistive Color Touchscreen
Weighing pan dimensions	1000×800 mm

Physical parameters	
Device dimensions	360×313×170 mm
Packaging dimensions	1000×1200×436 mm
Net weight	126 kg
Gross weight	160 kg
Construction	
Protection class	IP 66 / 67 construction, IP 43 terminal
Construction	mild steel St3S
Weighing pan material	Stainless steel AISI304
Communication interface	2×RS232, 2×USB-A, Ethernet, 4 IN / 4 OUT (digital), Wi-Fi
Power supply	100 – 240 V AC 50/60 Hz
Operating temperature	+10 – +40 °C
Relative humidity	15% – 80%

* Wi-Fi® is a registered trademark of Wi-Fi® Alliance.



Extra payment for verification



Accessories

Displays

Transponder card readers
RS 232 cables (scale - Ethernet)
RS 232 cables (scale - printer)
Barcode scanners

Label Printers

Receipt Printer
Additional Weighing platforms Module
RS 232 – USB Converter

Software

- E2R Weighing [WX-010-0099]
- RAD Key [WX-010-0005]
- RADWAG Remote Desktop [WX-010-0107]
- RADWAG Development Studio [WX-010-0104]

- E2R Weighing Records [WX-010-0038]
- Label Editor R02 [WX-010-0094]
- Scale Editor - EWAG 2.1 [WX-010-0173]

Device dimensions

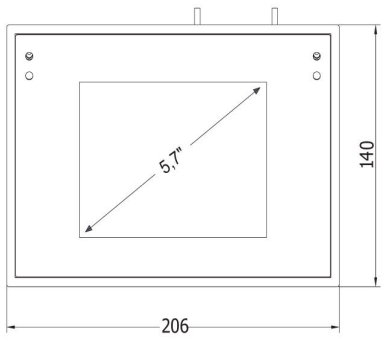
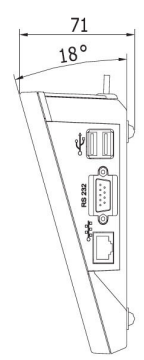
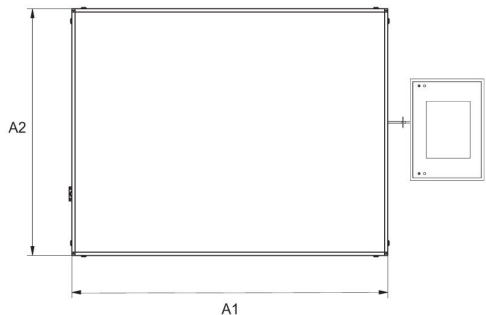
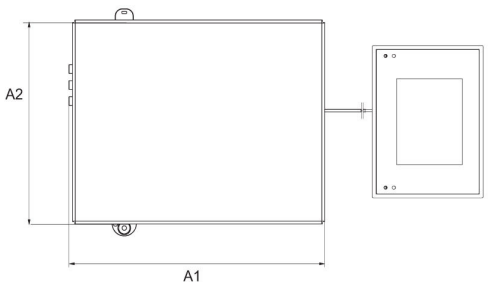
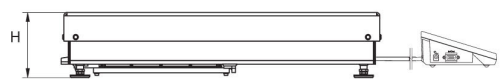
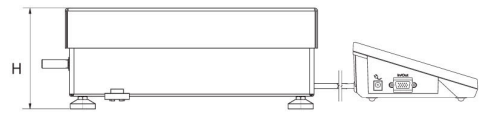

Scale type	A1	A2	H
PUE7.1.16 - 32.HRP	360	280	139±3
PUE7.1.62 - 120.HRP	500	500	175±3
PUE7.1.150 - 300.HRP	800	600	175±3
PUE7.1.300.1 - 1100.HRP	1000	800	175±3
PUE7.1.2000.HRP	1250	1000	175±3

dimensions in mm