



More information on the website
radwag.com/es/info,w1,XYP

Báscula de plataforma C315.150/300.C2.K





The drawings, photos and graphics used are for illustrative purposes only.

Funciones

 Indicador más/menos

 Desviaciones porcentuales

 Suma de pesajes

 Contar piezas

 Batería interna

 Cierre del pesaje máximo

 Medición en Newtons

 Procedimientos GLP

 Pesaje de animales

 Memoria Alibi

Datos técnicos

Parámetros metrológicos

Maxima capacidad [Max]	150 / 300 kg
Minima capacidad	1 kg
Legibilidad [d]	50 / 100 g
División de legalización [e]	50 / 100 g
Rango de tara	-300 kg
Clase OIML	III

Paramètros físicos	
Pantalla	LCD (con retroiluminación)
Longitud del cable	2,5 m
Dimensión de platillo	400×500 mm
Dimensiones de embalaje	720×620×210 mm
Masa neta	12,5 kg
Masa bruta	15 kg
Construcción	
Grado de protección	IP 65 construcción, IP 43 medidor
Construcción	de acero con recubrimiento en polvo St3S
Material del platillo	Acero inoxidable AISI304
Interface de comunicación	
Conectividad	RS232
Interfaces opcionales	RS232
Parámetros electricos	
Alimentación	100 – 240 V AC 50/60 Hz + batería
Consumo máximo de potencia	5 W
Horas de trabajo con baterías	max 8h
Condiciones ambientales	
Temperatura de trabajo	-10 – +40 °C
Temperatura de almacenamiento	-10 – +50 °C
Humedad relativa de aire	10% – 85% RH sin condensación
Medidor	C315



Extra payment for verification



Accesorios

Mesas antivibratil
 Adaptadores de corriente
 Cables RS 232 (Bascula a Impresora)
 Soportes, brazos
 Cables de corriente desde mechero de automóvil
 Pantallas
 Pantallas
 Cables RS 232, RS 485

Convertidor RS 232 a Ethernet
 Salidas del bucle de corriente AP2-1
 Cables RS 232, RS 485
 Convertidor RS 232 a USB
 Cables RS 232 (Bascula a Impresora)
 Convertidor RS 232 a RS 485
 Impresoras de recibos

Programas

- RAD Key [WX-010-0005]
- R-LAB [WX-010-0080]
- R Panel [WX-010-0187]
- Editor de Balanzas 2.1 [WX-010-0173]

Dimensiones de aparato



C315.F1.M

C315.F1.R



C315.C2.M

C315.C2.K

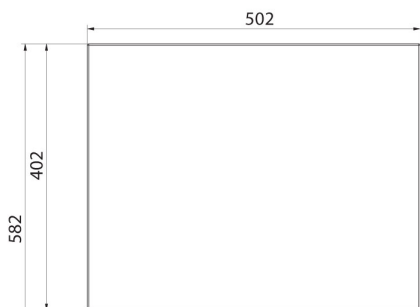
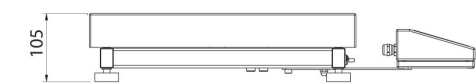

C315.C2.R

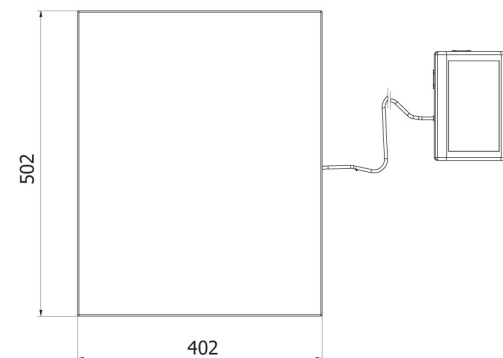
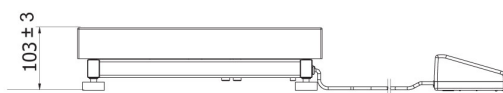

C315.C2.K

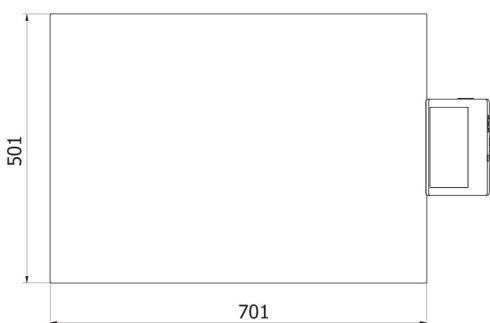
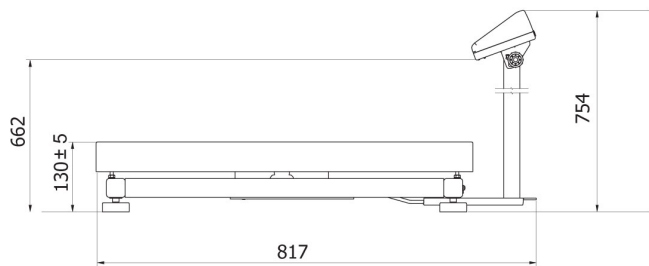

C315.C3.M

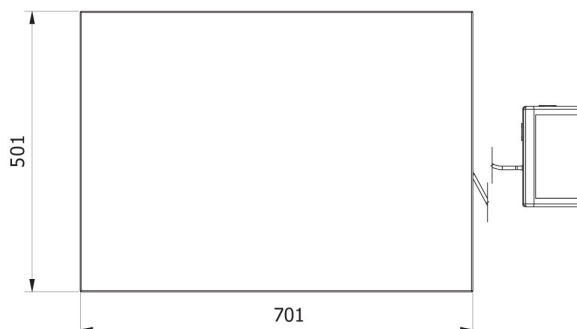
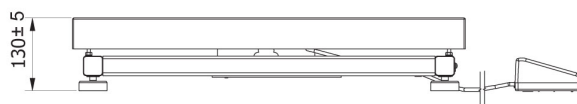

C315.C3.K