



More information on the website
radwag.com/en/info,w1,XYP

C315.150/300.C2.K Load Cell Platform Scale



The drawings, photos and graphics used are for illustrative purposes only.

Functions

 Plus/Minus Control

 Percent Weighing

 Totalizing

 Parts counting

 Internal battery

 Peak hold

 Newton unit measurement

 GLP Procedures

 Animal weighing

 ALIBI Memory

Datasheet

Metrological parameters	
Maximum capacity [Max]	150/300 kg
Minimum load	1 kg
Readability [d]	50/100 g
Verification unit [e]	50/100 g
Tare range	-300 kg
OIML Class	III

Physical parameters	
Display	LCD (backlit)
Weighing pan dimensions	400×500 mm
Packaging dimensions	720×620×210 mm
Net weight	12.5 kg
Gross weight	15 kg
Cable length	2.5 m
Indicator	C315
Construction	
Protection class	IP 65 construction, IP 43 indicator
Construction	mild steel St3S
Weighing pan material	Stainless steel AISI304
Communication interface	
Communication interface	RS232
Optional interfaces	RS232
Electrical parameters	
Power supply	100 – 240 V AC 50/60 Hz and battery
Power consumption max.	5 W
Operation time on batteries	max 8h
Environmental conditions	
Operating temperature	-10 ÷ +40 °C
Storage temperature	-10 ÷ +50 °C
Relative humidity	10% ÷ 85% RH no condensation



Extra payment for verification



Accessories

Antivibration Tables
 Power Adapters
 RS 232 cables (scale - printer)
 Stands, wall mounting kits and mounting brackets
 Cigarette lighter receptacle power supply cables
 Displays
 Displays
 RS 232, RS 485 cables

RS 232 – Ethernet Converter
 AP2-1 Current Loop Unit
 RS 232, RS 485 cables
 RS 232 – USB Converter
 RS 232 cables (scale - printer)
 RS 232 – RS 485 Converter
 Receipt Printer

Software

- RAD Key [WX-010-0005]
- R-Lab [WX-010-0080]

- R-Panel [WX-010-0187]
- Scale Editor 2.1 [WX-010-0173]

Device dimensions

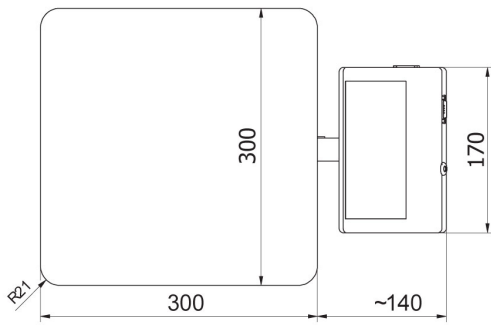

C315.F1.M

C315.F1.R

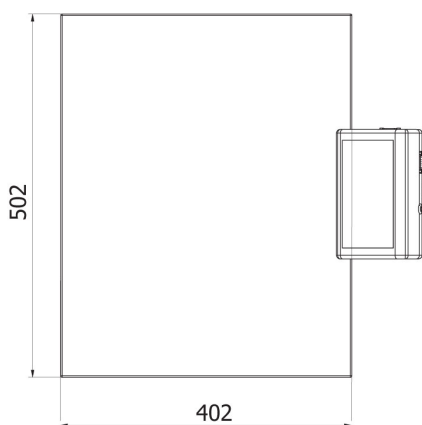
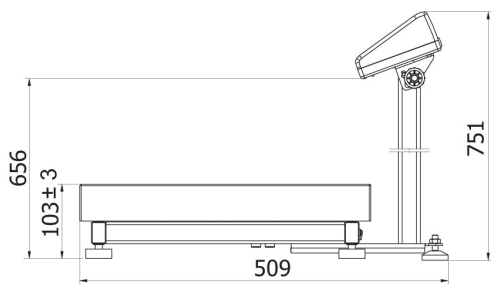

C315.C2.M

C315.C2.K

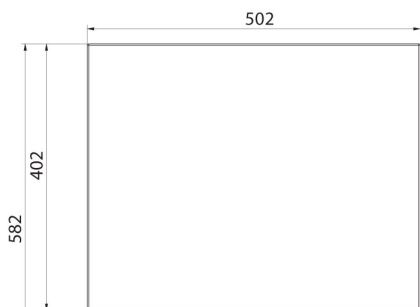
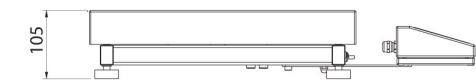

C315.C2.R

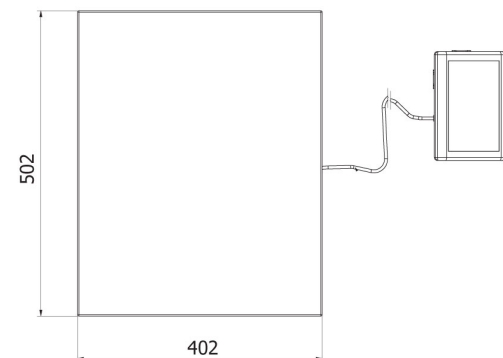
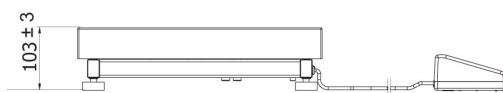

C315.C2.K

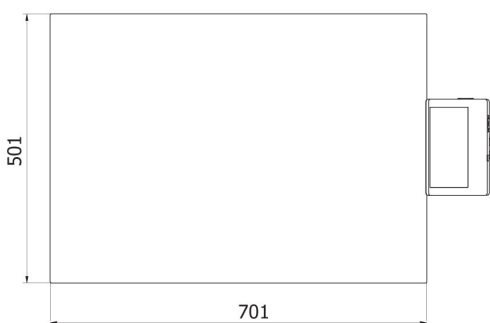
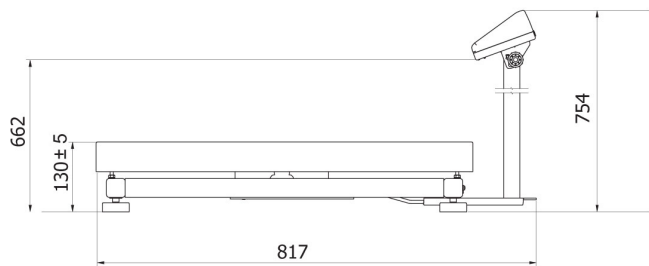

C315.C3.M

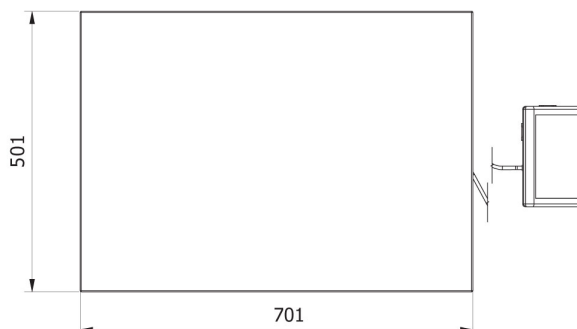
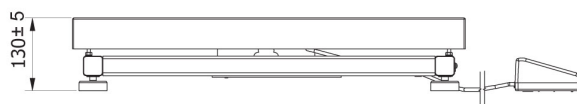

C315.C3.K