



More information on the website
radwag.com/es/info,w1,XLY

Báscula de plataforma C315.3.F1.M



The drawings, photos and graphics used are for illustrative purposes only.

Funciones

Indicador más/menos

Desviaciones porcentuales

Suma de pesajes

Contar piezas

Batería interna

Cierre del pesaje máximo

Medición en Newtons

Procedimientos GLP

Pesaje de animales

Memoria Alibi

Datos técnicos

Parámetros metrológicos

Maxima capacidad [Max]	3 kg
Minima capacidad	20 g
Legibilidad [d]	1 g
División de legalización [e]	1 g
Rango de tara	-3 kg
Legibilidad máxima para las balanzas no verificadas	0,2 g
Clase OIML	III

Parámetros físicos	
Pantalla	LCD (con retroiluminación)
Dimensión de platillo	300×300 mm
Dimensiones de embalaje	570×390×170 mm
Masa neta	5,3 kg
Masa bruta	5,5 kg
Construcción	
Grado de protección	IP 65 construcción, IP 43 medidor
Construcción	de acero con recubrimiento en polvo St3S
Material del platillo	Acero inoxidable AISI304
Interface de comunicación	
Conectividad	RS232
Interfaces opcionales	RS232
Parámetros eléctricos	
Alimentación	100 – 240 V AC 50/60 Hz + batería
Consumo máximo de potencia	5 W
Horas de trabajo con baterías	max 8h
Condiciones ambientales	
Temperatura de trabajo	-10 – +40 °C
Temperatura de almacenamiento	-10 – +50 °C
Humedad relativa de aire	10% – 85% RH sin condensación
Medidor	C315



Extra payment for verification



Accesorios

Mesas antivibratil
 Adaptadores de corriente
 Cables RS 232 (Bascula a Impresora)
 Cables de corriente desde mechero de automóvil
 Pantallas
 Pantallas
 Cables RS 232, RS 485
 Convertidor RS 232 a Ethernet

Salidas del bucle de corriente AP2-1
 Cables RS 232, RS 485
 Convertidor RS 232 a USB
 Cables RS 232 (Bascula a Impresora)
 Convertidor RS 232 a RS 485
 Impresoras de recibos
 Soportes, brazos

Programas

- RAD Key [WX-010-0005]
- R-LAB [WX-010-0080]

- R Panel [WX-010-0187]
- Editor de Balanzas 2.1 [WX-010-0173]

Dimensiones de aparato



C315.F1.M

C315.F1.R

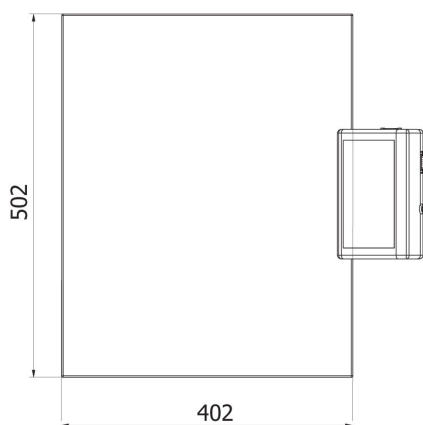
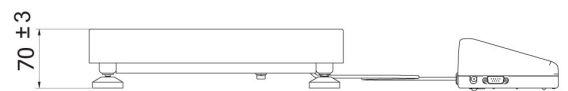

C315.C2.M

C315.C2.K