























More information on the website
radwag.com/en/info,w1,XBH

WLC 6.X2 Precision Balance



The drawings, photos and graphics used are for illustrative purposes only.

Functions

-  Autotest
-  Dosing
-  Percent Weighing
-  Parts counting
-  Peak hold
-  Formulation
-  Newton unit measurement
-  Statistics
-  Checkweighing
-  IR sensors
-  Under-pan weighing
-  GLP Procedures
-  Animal weighing
-  Density determination
-  Ambient conditions monitoring
-  Replaceable unit
-  Statistical Quality Control
-  ALIBI Memory
-  Mass for titrator
-  Wi-Fi

Datasheet

Metrological parameters	
Maximum capacity [Max]	6 kg
Readability [d]	0.1 g
Verification unit [e]	-
Tare range	-6 kg

Metrological parameters	
Repeatability	0.1 g
Linearity	±0.3 g
Stabilization time	2 s
Adjustment	internal (automatic)
Physical parameters	
Leveling system	manualny
Display	5" graphic color touchscreen
Weighing pan dimensions	195×195 mm
Packaging dimensions	430×270×190 mm
Net weight	2.2 kg
Gross weight	4 kg
Construction	
Protection class	IP 43
Components and software	
Database capacity	7
Communication interface	
Communication interface	2×RS232 ¹ , USB-A, USB-B, Ethernet, Wi-Fi
Electrical parameters	
Power supply	Adapter: 100 – 240V AC 50/60Hz 0.6A; 12V DC 1.2A Balance: 10 – 15VDC 0.6A max
Environmental conditions	
Operating temperature	+10 ÷ +40 °C

Repeatability is expressed as a standard deviation from 10 weighing cycles.

Stabilization time depends on the ambient conditions and the dynamics of weighing pan loading; specified for FAST profile.

¹ Barcode scanners, available as weighing instrument accessory, communicate with the instrument via RS232 interface exclusively.

* Wi-Fi® is a registered trademark of Wi-Fi® Alliance.



Accessories

Balance Storage Case
 Antivibration Tables
 RS 232 cables (scale - printer)
 Cigarette lighter receptacle power supply cables
 USB cable (scale - printer)
 Barcode scanners
 Under-pan weighing
 Density determination KIT

Displays
 Receipt Printer
 Protective cover for balances
 RS 232, RS 485 cables
 Additional modules
 RS 232 cables (scale - printer)
 RS 232 – RS 485 Converter

Software

• RAD Key [WX-010-0005]

• Alibi Reader [WX-010-0114]

Device dimensions

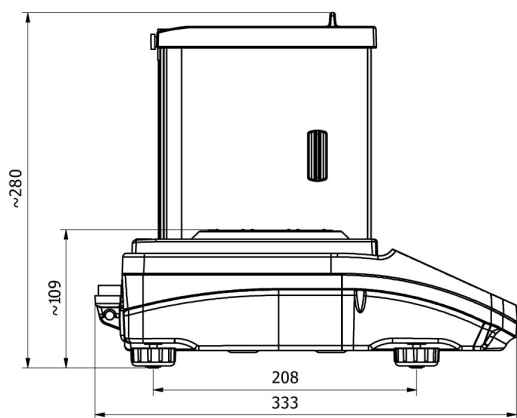

WLC X2, d = 0.001 mg

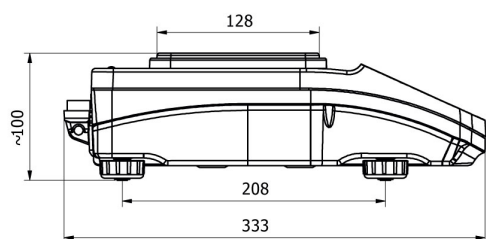
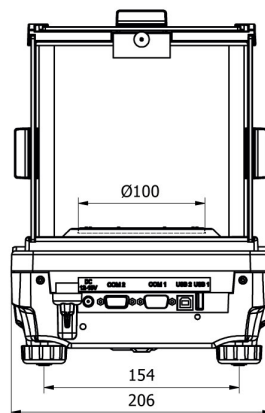

WLC X2, d = 0.01 mg

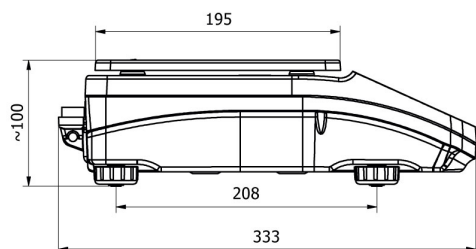
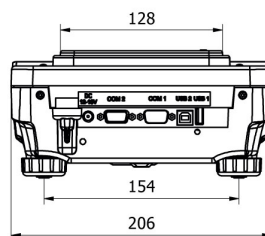

WLC X2, d = 0.1 mg

