



More information on the website  
[radwag.com/us/info,w1,WQ5](http://radwag.com/us/info,w1,WQ5)

# HY10.30.C2.K Multifunctional Scale



The drawings, photos and graphics used are for illustrative purposes only.

## Functions

-  Dosing
-  Labelling
-  Plus/Minus Control
-  Percent Weighing
-  Totalizing
-  Parts counting
-  Peak hold
-  Formulation
-  Newton unit measurement
-  Statistics
-  Checkweighing
-  GLP Procedures
-  Animal weighing
-  Differential weighing
-  Replaceable unit
-  Statistical Quality Control
-  ALIBI Memory
-  Transactions

## Datasheet

Maximum capacity [Max]	30 kg
Minimum load	200 g
Readability [d]	10 g
Verification unit [e]	10 g

Tare range	-30 kg
Max readability for non-verified scale	1 g
Adjustment	external
OIML Class	III
<b>Physical parameters</b>	
Display	10,1" graphic colour touchscreen
Cable length	2,5 m
Weighing pan dimensions	400×500 mm
Packaging dimensions	620×720×440 mm
Net weight	16 kg
Gross weight	18 kg
<b>Construction</b>	
Protection class	IP 65 construction, IP 68 (1h max)/69 terminal
Communication interface	2×RS232, 2×USB-A, Ethernet, 4 IN / 4 OUT (digital)
Optional interfaces	module Wi-Fi 802.11 b/g/n, module Profibus (DP SLAVE), module RS485, module PROFINET (RJ45), analog output module (4-20mA, 0-20mA, 0-10V) , 12IN / 12OUT (IN – 5-24 VDC, OUT – max 30 VDC, 0,5 ADC)
Power supply	100 – 240 V AC 50/60 Hz
Operating temperature	-10 – +40 °C
Relative humidity	10% – 85% RH no condensation

\* Wi-Fi® is a registered trademark of Wi-Fi® Alliance.



Extra payment for verification



## Accessories

RS 232 cables (scale - printer)  
 Transponder card readers  
 RS 232 cables (scale - ZEBRA printer)  
 RS 232 cables (scale - Ethernet)  
 Displays  
 RS 232, RS 485 cables  
 IN/OUT Cables  
 Barcode scanners  
 Label Printers

Stands, wall mounting kits and mounting brackets  
 Keypad, external switches  
 Receipt Printer  
 F1 Mass Standard - knob weights without adjustment chamber, set  
 USB cable (scale - printer)  
 Additional Weighing platforms Module  
 Additional modules  
 RS 232 – USB Converter

## Software

- E2R Weighing [WX-010-0099]
- E2R PGC [WX-010-0051]
- RAD Key [WX-010-0005]
- Label Editor R02 [WX-010-0094]
- Scale Editor - EWAG 2.1 [WX-010-0173]

- E2R Formulations [WX-010-0043]
- E2R Weighing Records [WX-010-0038]
- Audit Trail Reader [WX-010-0186]
- RADWAG Remote Desktop [WX-010-0107]
- RADWAG Development Studio [WX-010-0104]

# Device dimensions

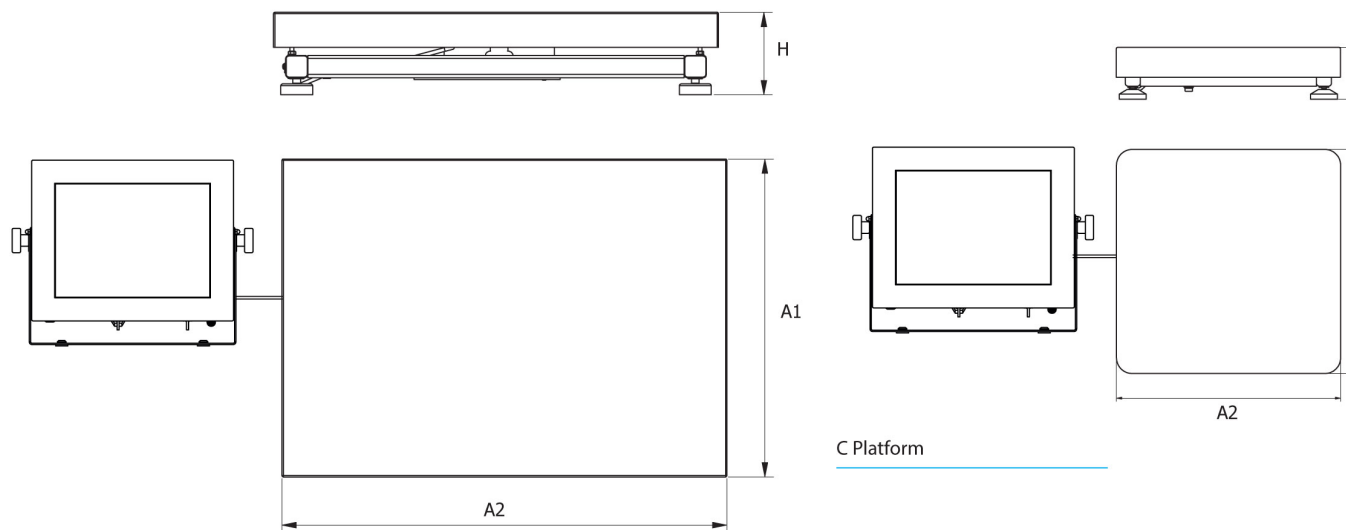

F1 Platform

C Platform

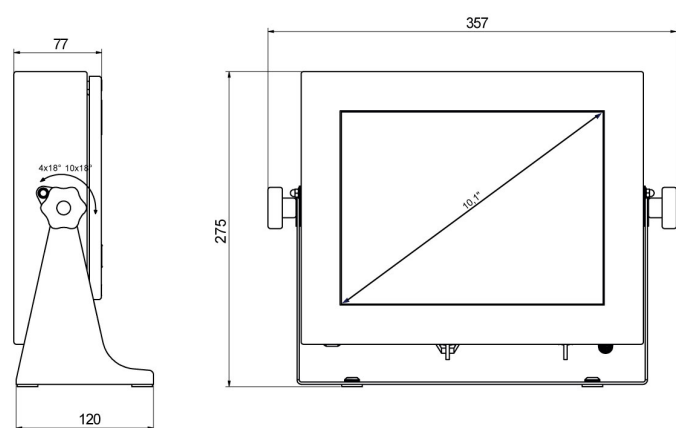

PUE HY10

Scale type	A1	A2	H
HY10.C2.K	400	500	103 ±3
HY10.C3.K	500	700	130 ±3
HY10.F1.K	300	300	70 ±3

dimensions in mm