

















More information on the website  
[radwag.com/fr/info,w1,W8K](http://radwag.com/fr/info,w1,W8K)

# Balance de précision WLY 6/F1/K



The drawings, photos and graphics used are for illustrative purposes only.

## Fonctions

-  Dosing
-  Labelling
-  Plus/Minus Control
-  Percent Weighing
-  Totalizing
-  Parts counting
-  Peak hold
-  Formulation
-  Newton unit measurement
-  Statistics
-  Checkweighing
-  IR sensors
-  Animal weighing
-  Differential weighing
-  ALIBI Memory

## Paramètres Techniques

Paramètres métrologiques	
Capacité maximale [Max]	6 kg
Capacité minimale [Min]	5 g
Précision de lecture	0,1 g
Échelon de légalisation [e]	1 g
Étendue de tare	-6 kg
Répétabilité	0,1 g

Paramètres métrologiques	
Linéarité	±0,1 g
Temps de stabilisation	3 s
Classe de précision OIML	II
Paramètres physiques	
Système de nivellement	manuel
Dimension du plateau	300×300 mm
Dimensions de colis	570×390×170 mm
Masse nette	5,2 kg
Masse brute	6 kg
Construction	
Degré de protection	IP 43
Interface de Communication	
Interface de Communication	2×RS232, 2×USB-A, Ethernet, 4 IN / 4 OUT (numériques), Wi-Fi
Paramètres électriques	
Alimentation	Adapter: 100 – 240V AC 50/60Hz 1A; 15V DC 2,4A Balance: 10 – 28V DC 1A max
Conditions environnementales	
Température du travail	+15 ÷ +30 °C
Température de stockage	-25 - +70 °C
Humidité relative d'air	10% ÷ 85% RH sans condensation

Répétabilité exprimée comme un écart standardisé de 10 placements de chargé.

Temps de stabilisation dépend de conditions externes et de la dynamique du placement d'un poids sur le plateau; déterminé pour le profil FAST.

\* Wi-Fi® is a registered trademark of Wi-Fi® Alliance.



## Accessoires

Tables antivibratoires  
Lecteurs de cartes à transpondeur  
Alimentateurs  
Câbles RS 232 (balance – imprimante)  
Câbles d'alimentation de cigare-allume  
Lecteurs de code-barres  
Pesage sous la balance  
Câbles RS 232, RS 485  
Imprimantes d'étiquettes  
Modules complémentaires  
Afficheurs

Câbles d'Entrées/ de Sorties  
Claviers, manipulateurs  
Supports, Statifs, bras-supports  
Imprimante de tickets de caisse  
Poids de classe F1 - cylindrique à bouton sans cavité d'ajustage, ensembles  
Sorties de boucle de courant AP2-1  
Câbles RS 232, RS 485  
Modules de plateforme supplémentaires  
Convertisseur RS 232 – USB  
Câbles RS 232 (balance – imprimante)

## Software

- E2R Pesages [WX-010-0099]
- E2R Registre [WX-010-0038]
- Audit Trail Reader [WX-010-0186]

- E2R Recettes [WX-010-0043]
- RAD Key [WX-010-0005]
- Éditeur D'étiquettes R02 [WX-010-0094]

- RADWAG Remote Desktop [WX-010-0107]
- Éditeur de Balances 2.1 [WX-010-0173]

- R-LAB [WX-010-0080]
- RADWAG Studio du Développement [WX-010-0104]

## Dimensions d'appareil



F1 version



D2 version

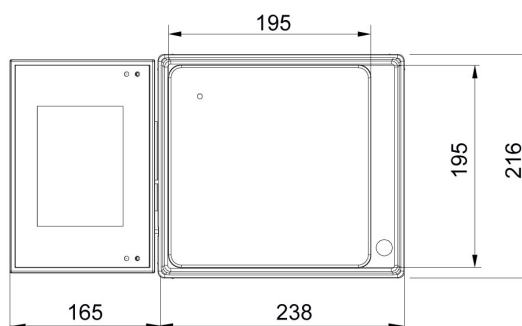

C2 version

