



More information on the website
radwag.com/it/info,w1,VLJ

Basamento versione „waterproof” con cella di carico in acciaio inox H315.30/60.HR3.M





The drawings, photos and graphics used are for illustrative purposes only.

Funzioni

 Plus/Minus Control

 Percent Weighing

 Totalizing

 Parts counting

 Internal battery

 Peak hold

 Newton unit measurement

 Animal weighing

Specifiche

Parametri metrologici	
Portata massima [Max]	30 / 60 kg
Portata minima [Min]	200 g
Divisione [d]	10 / 20 g
Intervallo di verifica della bilancia [e]	10 g
Campo di tara	-60 kg
Classe OIML	III
Parametri fisici	
Display	LCD (backlit)
Dimensione piatto	410x410 mm

Parametri fisici	
Dimensioni del pacco	510×510×270 mm
Peso netto	15,5 kg
Peso lordo	17,3 kg
Costruzione	
Punteggio IP	IP 68 construction, IP 68 cell, IP 68 (1h max)/69 terminal
Costruzione	Stainless steel AISI316
Interfaccia di comunicazione	
Interfaccia	RS232, USB
Interfacce opzionali	RS232 or RS485 or 4IN/4OUT or Ethernet or analog output 4-20 mA
Parametri elettrici	
Alimentatore	100 – 240 V AC 50/60 Hz
Alimentatore opzionale	internal rechargeable battery
Tempo operativo delle batterie	max 7h
Environmental conditions	
Ambiente di lavoro	-10 – +40 °C
Temperatura di stoccaggio	-25 – +70 °C
Umidità relativa	10% – 85% RH no condensation



Extra payment for verification



Accessori

Cavo seriale RS 232 (connessione bilance - Stampanti)
 Tavoli antivibranti
 Display
 Cavo seriale RS 232 (connessione bilance - Ethernet)
 Cavo seriale RS 232, RS 485
 RS 232 – Ethernet Converter
 USB adatper

Stampanti di ricevuta
 cavo USB (connessione bilance - stampanti)
 Supporto, set di montaggio a muro e braccetti di montaggio
 RS 232 – USB Converter
 Banco a rulli
 Cavo seriale RS 232, RS 485

Software

- RAD Key [WX-010-0005]
- R-LAB [WX-010-0080]

- R Panel [WX-010-0187]
- Editore per sistemi di pesatura 2.1 [WX-010-0173]

Device dimensions

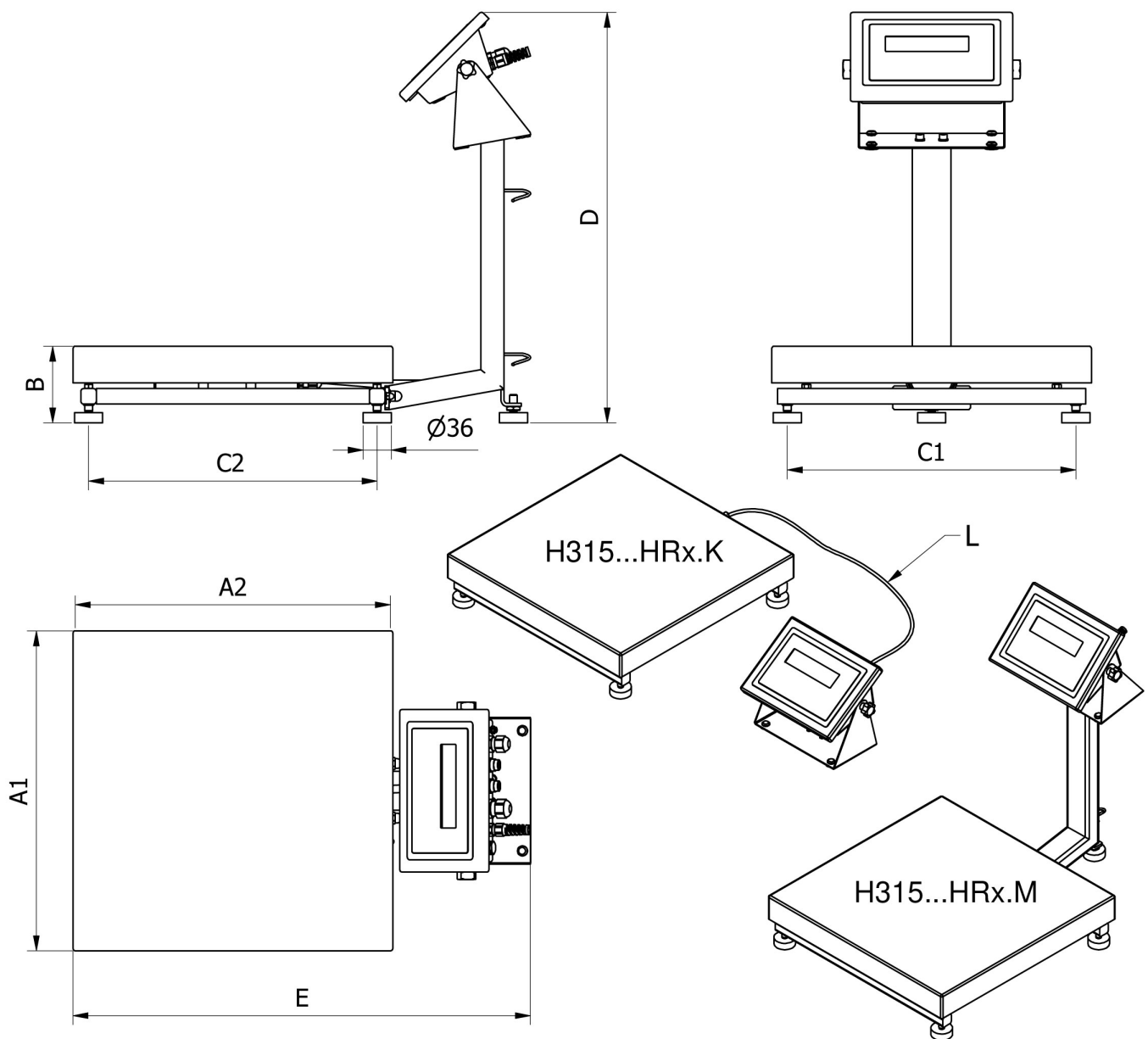

		A1	A2	B	C1	C2	D	E	L
H315...HR2.M	250 x 300	246	306	104 ± 3	208	268	~525	~483	
H315...HR2.K	250 x 300	246	306	104 ± 3	208	268	-	-	1,5m
H315...HR3.M	410 x 410	410	410	98 ± 2	370	370	~525	~587	
H315...HR3.K	410 x 410	410	410	98 ± 2	370	370	-	-	2,5m
H315...HR4.M	500 x 500	497	497	155 ± 5	400	400	~767	~650	
H315...HR4.K	500 x 500	497	497	155 ± 5	400	400	-	-	2,5m
H315...HR3/5.M	400 x 600	597	397	155 ± 5	500	300	~767	~550	
H315...HR3/5.K	400 x 600	597	397	155 ± 5	500	300	-	-	2,5m
H315...HR5.M	600 x 600	597	597	155 ± 5	500	500	~767	~750	
H315...HR5.K	600 x 600	597	597	155 ± 5	500	500	-	-	2,5m