





















More information on the website
radwag.com/fr/info,w1,VL6

Balance à haute résolution HY10.120.HRP.M2.1



The drawings, photos and graphics used are for illustrative purposes only.

Fonctions

-  Dosing
-  Labelling
-  Plus/Minus Control
-  Percent Weighing
-  Totalizing
-  Parts counting
-  Peak hold
-  Formulation
-  Newton unit measurement
-  Statistics
-  Checkweighing
-  GLP Procedures
-  Animal weighing
-  Differential weighing
-  Replaceable unit
-  Statistical Quality Control
-  ALIBI Memory
-  Transactions

Paramètres Techniques

Paramètres métrologiques

Capacité maximale [Max]	120 kg
Capacité minimale [Min]	50 g
Capacité préliminaire	30 kg
Précision de lecture	1 g

Paramètres métrologiques	
Échelon de légalisation [e]	10 g
Étendue de tare	-120 kg
Répétabilité	1 g
Linéarité	±2 g
Temps de stabilisation	3 s
Ajustage	interne (automatique)
Classe de précision OIML	II
Nombre maximal d'échelons de légalisation	12000 e

Paramètres physiques	
Afficheur	10,1" graphique couleurs écran tactile
Dimension du plateau	500x400 mm
Dimensions de colis	610x710x505 mm
Masse nette	37 kg
Masse brute	52 kg

Construction	
Degré de protection	IP 66 / 67 construction, IP 68 / 69 terminal
Construction	acier pulvériséacier St3S
Matériel du plateau	Acier inoxydable AISI304

Interface de Communication	
Interface de Communication	2xRS232, 2xUSB-A, Ethernet, 4 IN / 4 OUT (numériques)
Interfaces optionnelles	module Wi-Fi 802.11 b/g/n, module Profibus (DP SLAVE), module RS485, module PROFINET (RJ45), module de sorties analogiques (4-20mA, 0-20mA, 0-10V) , 12IN / 12OUT (IN – 5-24 VDC, OUT – max 30 VDC, 0,5 ADC)

Paramètres électriques	
Alimentation	100 – 240 V AC 50/60 Hz

Conditions environnementales	
Température du travail	+10 – +40 °C
Humidité relative d'air	15% – 80%

Répétabilité exprimée comme un écart standardisé de 10 placements de chargé.

Humidité relative de l'air dans des conditions sans condensation.

Temps de stabilisation dans des conditions ambiantes optimales.

* Wi-Fi® is a registered trademark of Wi-Fi® Alliance.



Extra payment for verification



Accessoires

Câbles RS 232 (balance – imprimante)
Lecteurs de cartes à transpondeur
Câbles RS 232 (balance – imprimante ZEBRA)
Câbles de réseau (balance – Ethernet)
Afficheurs
Câbles RS 232, RS 485

Imprimantes d étiquettes
Supports, Statifs, bras-supports
Claviers, manipulateurs
Imprimante de tickets de caisse
Câble USB (balance – imprimante)
Modules de plateforme supplémentaires

Software

- E2R Pesages [WX-010-0099]
- E2R Registre [WX-010-0038]
- Audit Trail Reader [WX-010-0186]
- RADWAG Remote Desktop [WX-010-0107]
- Éditeur de Balances 2.1 [WX-010-0173]
- E2R Recettes [WX-010-0043]
- RAD Key [WX-010-0005]
- Éditeur D'étiquettes R02 [WX-010-0094]
- R-LAB [WX-010-0080]
- RADWAG Studio du Développement [WX-010-0104]

Dimensions d'appareil

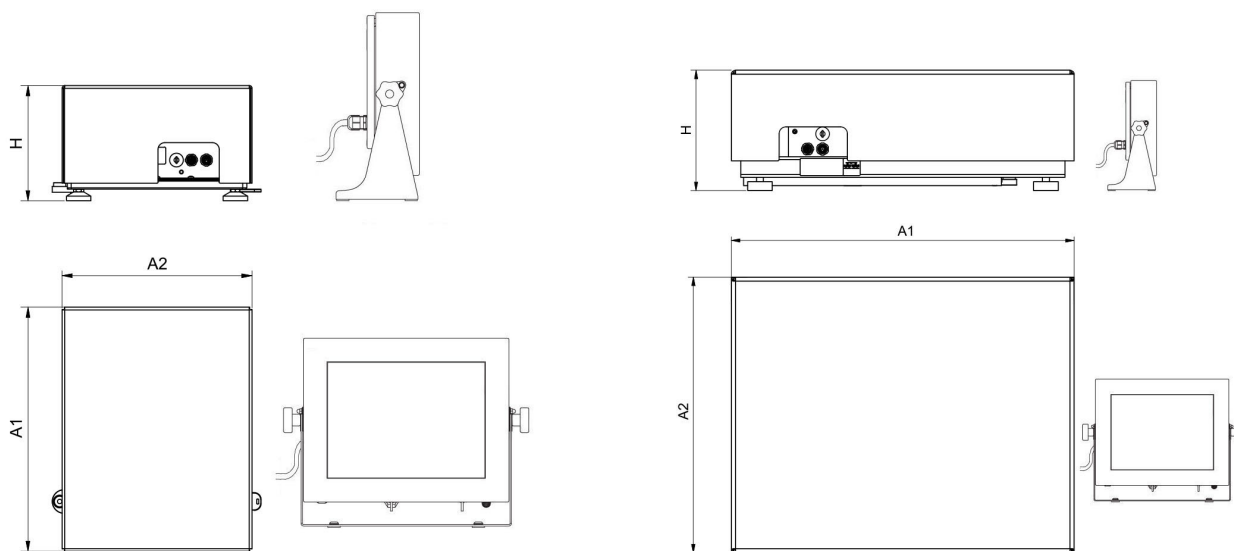

HY10.16 - 32.HRP

HY10.HRP

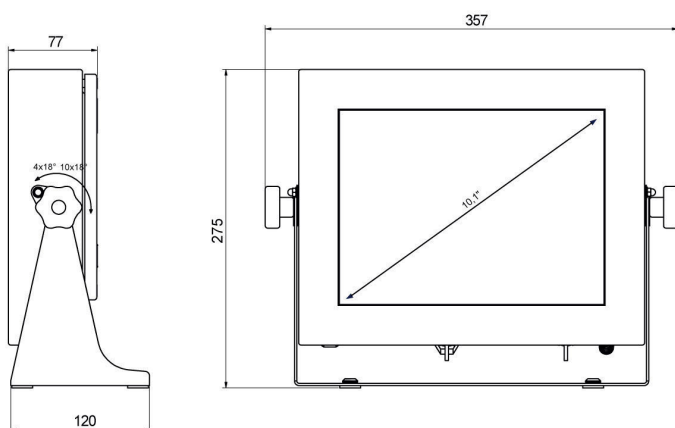

PUE HY10

Scale type	A1	A2	H
HY10.(16-32).HRP	360	280	180±5
HY10.(62-150).HRP	500	400	180±5
HY10.150.2.HRP	500	500	180±5
HY10.(150.1-300).HRP	800	600	180±5
HY10.(300.1-1100).HRP	1000	800	180±5
HY10.(2000).HRP	1250	1000	180±5

Dimensions in mm