

















More information on the website  
radwag.com/it/info,w1,V5U

# Bilancia multifunzione WPY 15/F1



The drawings, photos and graphics used are for illustrative purposes only.

## Funzioni

-  Dosing
-  Labelling
-  Plus/Minus Control
-  Percent Weighing
-  Totalizing
-  Parts counting
-  Peak hold
-  Formulation
-  Newton unit measurement
-  Statistics
-  Checkweighing
-  IR sensors
-  Animal weighing
-  Differential weighing
-  ALIBI Memory

## Specifiche

Parametri metrologici	
Portata massima [Max]	15 kg
Portata minima [Min]	100 g
Divisione [d]	5 g
Campo di tara	-15 kg
Massima leggibilità per bilance non verificate	0,5 g
Tempo di stabilizzazione	2 s

Parametri metrologici	
Calibrazione	external
Classe OIML	III
Parametri fisici	
Display	5,7" Resistive Color Touchscreen
Dimensione piatto	300×300 mm
Dimensioni del pacco	570×390×170 mm
Peso netto	5,3 kg
Peso lordo	6,1 kg
Costruzione	
Punteggio IP	IP 43
Interfaccia di comunicazione	
Interfaccia	2×RS232, 2×USB-A, Ethernet, 4 IN / 4 OUT (digital), Wi-Fi
Parametri elettrici	
Alimentatore	100 – 240 V AC 50/60 Hz
Environmental conditions	
Ambiente di lavoro	-10 – +40 °C

**Il tempo di stabilizzazione** dipende dalle condizioni esterne e dalla dinamica di posizionamento del carico sul piatto; specificato per il profilo FAST.

\* Wi-Fi® is a registered trademark of Wi-Fi® Alliance.



Extra payment for verification



## Accessori

Tavoli antivibranti  
 Lettore di tessere transponder  
 Cavo seriale RS 232 (connessione bilance - Stampanti)  
 Cavo di alimentazione con spina per accendisigari  
 Lettore di codici a barre  
 Cavo seriale RS 232, RS 485  
 stampanti per etichette  
 Display  
 cavi IN/OUT

Tastiera, interruttori esterni  
 Supporto, set di montaggio a muro e braccetti di montaggio  
 Stampanti di ricevuata  
 Pesì standard F1 - cilindrici, set  
 AP2-1 Power loop output  
 Cavo seriale RS 232, RS 485  
 Moduli aggiuntivi della piattaforma  
 RS 232 – USB Converter  
 Cavo seriale RS 232 (connessione bilance - Stampanti)

## Software

- E2R Weighing [WX-010-0099]
- E2R PGC [WX-010-0051]
- RAD Key [WX-010-0005]
- Editore di etichette R02 [WX-010-0094]
- R-LAB [WX-010-0080]
- Software „Development Studio“ RADWAG [WX-010-0104]

- E2R Formulazione [WX-010-0043]
- E2R Weighing Records [WX-010-0038]
- Audit Trail Reader [WX-010-0186]
- RADWAG Remote Desktop [WX-010-0107]
- Editore per sistemi di pesatura 2.1 [WX-010-0173]

## Device dimensions

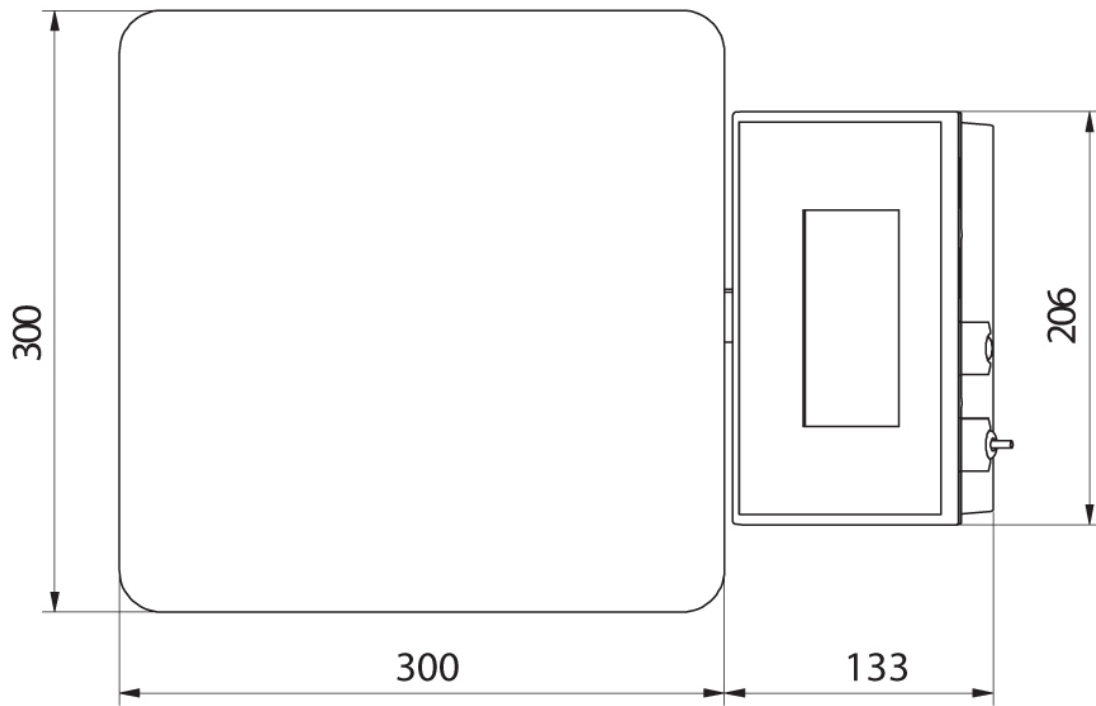
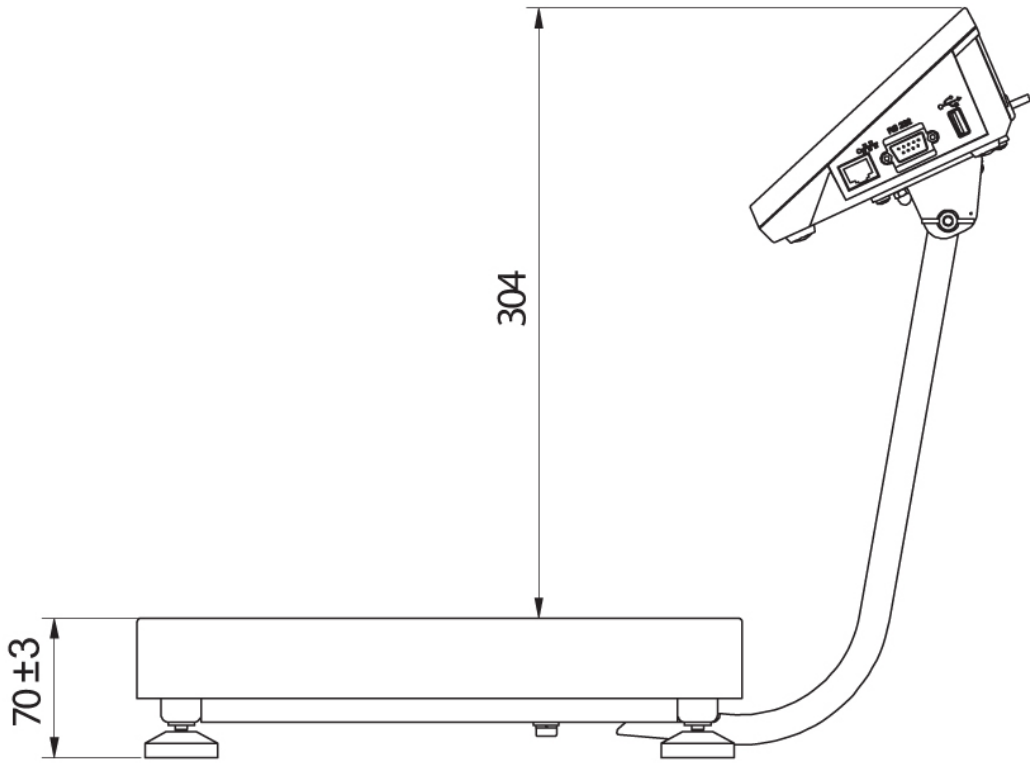

WPY F1/M

---