



















More information on the website
radwag.com/it/info,w1,V5J

Bilancia WLY 60/120.C2.K.PGC



The drawings, photos and graphics used are for illustrative purposes only.

funzioni

-  Dosing
-  Labelling
-  Plus/Minus Control
-  Percent Weighing
-  Totalizing
-  Parts counting
-  Peak hold
-  Formulation
-  Newton unit measurement
-  Statistics
-  Checkweighing
-  IR sensors
-  Animal weighing
-  Differential weighing
-  Packaged Goods Control
-  ALIBI Memory

Foglio di calcolo

Parametri metrologici	
Capacità massima [Max]	60 / 120 kg
Pesata minima	0,5 kg
Accuratezza	10 / 20 g
Intervallo di verifica della bilancia [e]	10 / 20 g
Intervallo di tara	-120 kg
Ripetibilità	10 / 20 g

Parametri metrologici	
Linearita	±10 / 20 g
Tempo di stabilizzazione	3 s
Calibrazione	external
Classe OIML	II
Parametri fisici	
Sistema di livellamento	manual
Display	5,7" Resistiv-Farb-Touchscreen
Dimensioni del piatto di pesata	400x500 mm
Dimensioni del pacco	720x620x210 mm
Peso netto	12,5 kg
Peso lordo	15 kg
Lunghezza del cavo	2,5 m
Costruzione	
Punteggio IP	IP 43
Interfaccia di comunicazione	
Interfaccia	2xRS232, 2xUSB-A, Ethernet, 4 IN / 4 OUT (digital), Wi-Fi
Parametri elettrici	
Alimentatore	Adapter: 100 – 240V AC 50/60Hz 1A; 15V DC 2,4A Balance: 10 – 28V DC 1A max
Environmental conditions	
Temperatura di lavoro	+15 ÷ +30 °C
Temperatura di stoccaggio	-25 - +70 °C
Umidita atmosferica	10% ÷ 85% RH no condensation

* Wi-Fi® is a registered trademark of Wi-Fi® Alliance.



Accessori

Lettore di tessere transponder

Alimentatore

Cavo seriale RS 232 (connessione bilance - Stampanti)

Cavo di alimentazione con spina per accendisigari

Lettore di codici a barre

Under-pan weighing

Cavo seriale RS 232, RS 485

stampanti per etichette

Moduli aggiuntivi

Display

cavi IN/OUT

Tastiera, interruttori esterni

Supporto, set di montaggio a muro e braccetti di montaggio

Stampanti di ricevu

Pesi standard F1 - cilindrici, set

AP2-1 Power loop output

Cavo seriale RS 232, RS 485

Moduli aggiuntivi della piattaforma

RS 232 – USB Converter

Cavo seriale RS 232 (connessione bilance - Stampanti)

Software

• E2R Weighing [WX-010-0099]

• E2R Weighing Records [WX-010-0038]

• Audit Trail Reader [WX-010-0186]

• E2R PGC [WX-010-0051]

• RAD Key [WX-010-0005]

• Editore di etichette R02 [WX-010-0094]

- RADWAG Remote Desktop [WX-010-0107]
- Editore per sistemi di pesatura 2.1 [WX-010-0173]

- R-LAB [WX-010-0080]
- Software „Development Studio” RADWAG [WX-010-0104]

Device dimensions



F1 version



D2 version

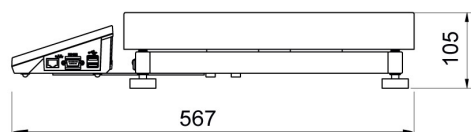
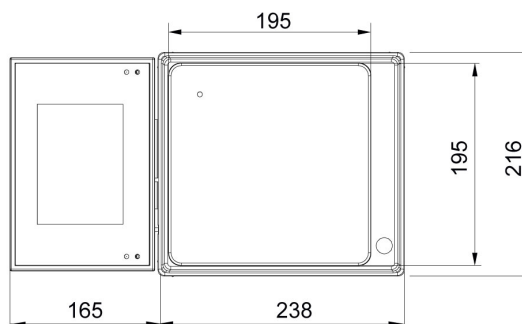

C2 version

