



















More information on the website  
radwag.com/fr/info,w1,V5J

# Balance WLY 60/120.C2.K.CPP



The drawings, photos and graphics used are for illustrative purposes only.

## Fonctions

-  Dosing
-  Labelling
-  Plus/Minus Control
-  Percent Weighing
-  Totalizing
-  Parts counting
-  Peak hold
-  Formulation
-  Newton unit measurement
-  Statistics
-  Checkweighing
-  IR sensors
-  Animal weighing
-  Differential weighing
-  Packaged Goods Control
-  ALIBI Memory

## Paramètres Techniques

Paramètres métrologiques	
Capacité maximale [Max]	60 / 120 kg
Capacité minimale [Min]	0,5 kg
Précision de lecture	10 / 20 g
Échelon de légalisation [e]	10 / 20 g
Étendue de tare	-120 kg
Répétabilité	10 / 20 g

Paramètres métrologiques	
Linéarité	±10 / 20 g
Temps de stabilisation	3 s
Ajustage	externe
Classe de précision OIML	II
Paramètres physiques	
Système de nivellement	manuel
Afficheur	5,7" Écran tactile couleur résistif
Longueur de câble	2,5 m
Dimension du plateau	400×500 mm
Dimensions de colis	720×620×210 mm
Masse nette	12,5 kg
Masse brute	15 kg
Construction	
Degré de protection	IP 43
Interface de Communication	
Interface de Communication	2×RS232, 2×USB-A, Ethernet, 4 IN / 4 OUT (numériques), Wi-Fi
Paramètres électriques	
Alimentation	Adapter: 100 – 240V AC 50/60Hz 1A; 15V DC 2,4A Balance: 10 – 28V DC 1A max
Conditions environnementales	
Température du travail	+15 – +30 °C
Température de stockage	-25 – +70 °C
Humidité relative d'air	10% – 85% RH sans condensation

\* Wi-Fi® is a registered trademark of Wi-Fi® Alliance.



## Accessoires

Lecteurs de cartes à transpondeur

Alimentateurs

Câbles RS 232 (balance – imprimante)

Câbles d'alimentation de cigare-allume

Lecteurs de code-barres

Pesage sous la balance

Câbles RS 232, RS 485

Imprimantes d'étiquettes

Modules complémentaires

Afficheurs

Câbles d'Entrées/ de Sorties

Claviers, manipulateurs

Supports, Statifs, bras-supports

Imprimante de tickets de caisse

Poids de classe F1 - cylindrique à bouton sans cavité d'ajustage, ensembles

Sorties de boucle de courant AP2-1

Câbles RS 232, RS 485

Modules de plateforme supplémentaires

Convertisseur RS 232 – USB

Câbles RS 232 (balance – imprimante)

## Software

• E2R Pesages [WX-010-0099]

• E2R Registre [WX-010-0038]

• E2R CPP [WX-010-0051]

• RAD Key [WX-010-0005]

- Audit Trail Reader [WX-010-0186]
- RADWAG Remote Desktop [WX-010-0107]
- Éditeur de Balances 2.1 [WX-010-0173]

- Éditeur D'étiquettes R02 [WX-010-0094]
- R-LAB [WX-010-0080]
- RADWAG Studio du Développement [WX-010-0104]

## Dimensions d'appareil

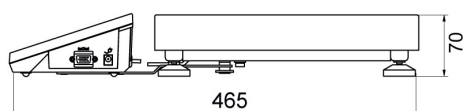

F1 version

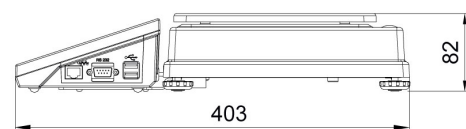
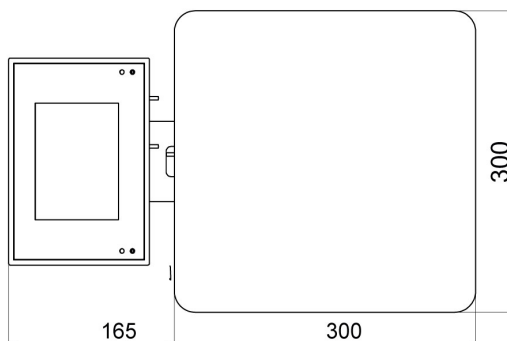

D2 version

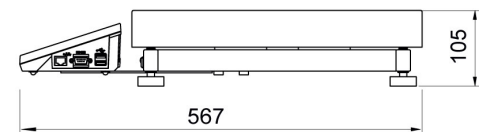
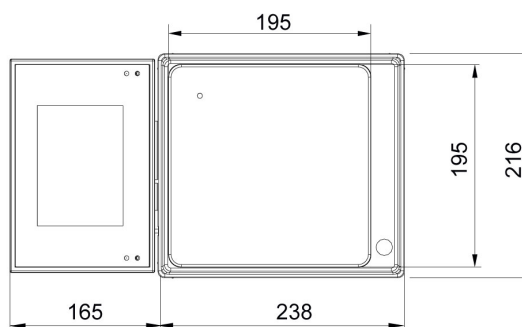

C2 version

