

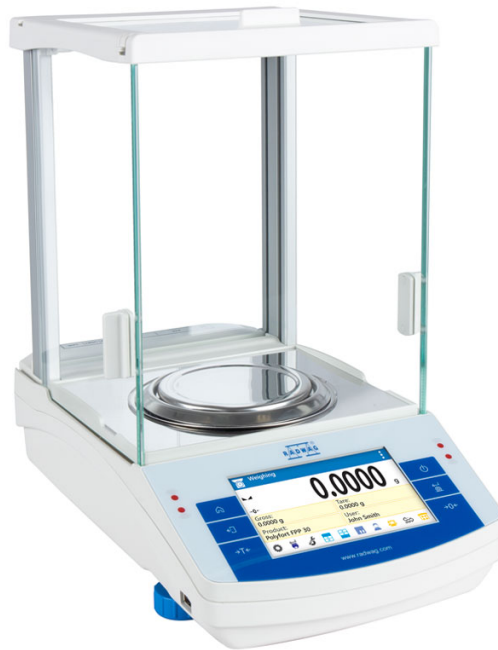





















More information on the website  
[radwag.com/us/info,w1,TS2](http://radwag.com/us/info,w1,TS2)

# AS 220.X2 PLUS Analytical Balance



The drawings, photos and graphics used are for illustrative purposes only.

## Functions

-  Autotest
-  Dosing
-  Percent Weighing
-  Parts counting
-  Peak hold
-  Formulation
-  Newton unit measurement
-  Statistics
-  Checkweighing
-  IR sensors
-  Under-pan weighing
-  GLP Procedures
-  Animal weighing
-  Density determination
-  Ambient conditions monitoring
-  Replaceable unit
-  Statistical Quality Control
-  ALIBI Memory
-  Mass for titrator
-  Wi-Fi

## Datasheet

Maximum capacity [Max]	220 g
Minimum load	10 mg
Readability [d]	0,1 mg
Verification unit [e]	1 mg

Tare range	-220 g
Standard repeatability [5% Max]	0,06 mg
Standard repeatability [Max]	0,07 mg
Standard minimum weight (USP)	120 mg
Standard minimum weight (U=1%, k=2)	12 mg
Permissible repeatability [5% Max]	0,09 mg
Permissible repeatability [Max]	0,1 mg
Linearity	±0,2 mg
Stabilization time	2 s
Adjustment	internal (automatic)
OIML Class	I
<b>Physical parameters</b>	
Leveling system	semi-automatic - LevelSENSING
Display	5" graphic color touchscreen
Weighing chamber doors	manual
Delivery components	Balance, weighing pan, weighing pan shield, bottom cover, power supply.
Weighing chamber dimensions	190×190×226 mm
Weighing pan dimensions	ø100 mm
Packaging dimensions	490×400×520 mm
Net weight	7,06 kg
Gross weight	8,5 kg
<b>Construction</b>	
Protection class	IP 43
<b>Database capacity</b>	
Database capacity	7
<b>Features of use</b>	
Touch-free operation	2 IR Sensors
<b>Communication interface</b>	
Communication interface	RS232 <sup>1</sup> , 2×USB-A (interchangeable), USB-B, Wi-Fi, Ethernet
<b>Power supply</b>	
Power supply	Adapter: 100 – 240V AC 50/60Hz 0,6A; 12V DC 1,2A Balance: 12 – 15V DC 0,8A max
Power consumption max.	4 W
<b>Operating temperature</b>	
Operating temperature	+10 ÷ +40 °C
Ambient conditions monitoring (option)	THBR 2.0 System, THBR BOX, THB P, THB W, THB S
Relative humidity	40% ÷ 80%

\* Wi-Fi® is a registered trademark of Wi-Fi® Alliance.



Extra payment for verification



## Accessories

Antivibration tables  
Holders for laboratory flasks  
Power Adapters  
Cigarette lighter receptacle power supply cables  
Density determination KIT  
USB cable (scale - printer)  
Professional Weighing Tables  
Barcode scanners  
Holders for test tubes and filters  
Workstation for pipettes calibration  
RS 232, RS 485 cables

THBR 2.0 System - Ambient Conditions Monitoring  
Displays  
Protective cover for balances  
Weighing dishes  
Antistatic ionizer  
Receipt Printer  
RS 232, RS 485 cables  
Additional modules  
Under-pan weighing  
RS 232 cables (scale - printer)  
RS 232 – RS 485 Converter

## Software

- RAD Key [WX-010-0005]
- Scale Editor - EWAG 2.1 [WX-010-0173]

- Alibi Reader PC Software [WX-010-0114]
- RADWAG Development Studio [WX-010-0104]

## Device dimensions

AS X2 PLUS, d = 0.01 mg

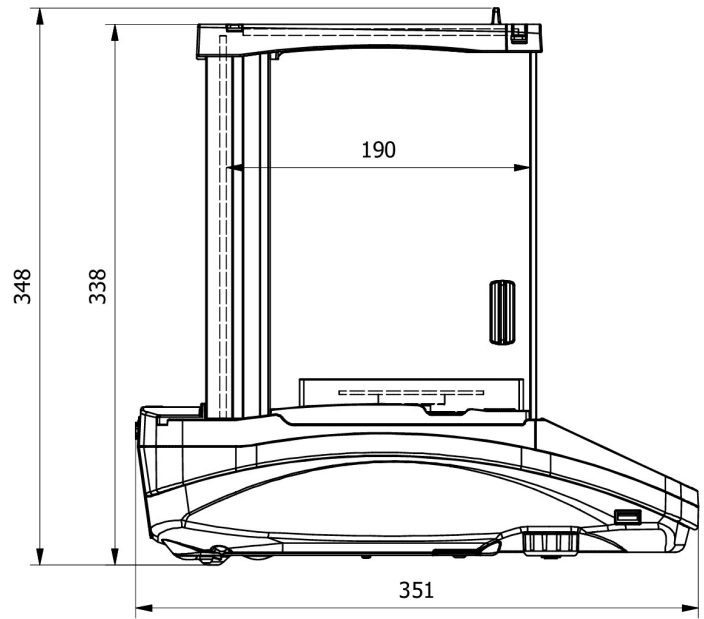
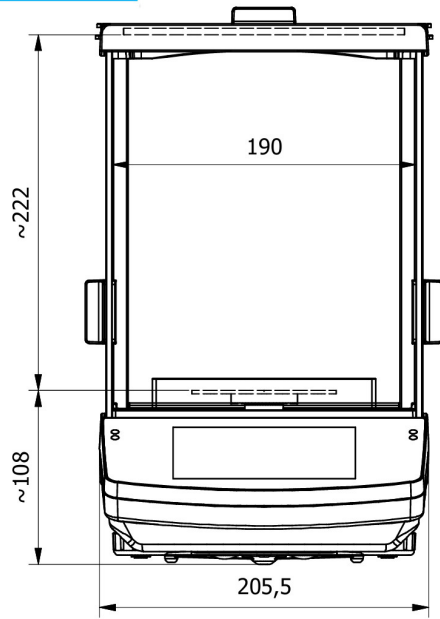

AS X2 PLUS, d = 0.1 mg

