



More information on the website
radwag.com/tr/info,w1,T9Z

C315.30/60.C3.M Yük Hücreli Platform Terazi



The drawings, photos and graphics used are for illustrative purposes only.

Fonksiyonlar

 Plus/Minus Control

 Percent Weighing

 Totalizing

 Parts counting

 Internal battery

 Peak hold

 Newton unit measurement

 GLP Procedures

 Animal weighing

 ALIBI Memory

Teknik Veriler

Metrolojik parametreler

Maksimum yük [Max]	30 / 60 kg
Minimum yük [Min]	200 g
Okuma için doğruluğu [d]	10 / 20 g
Yasallaştırma birimi [e]	10 / 20 g
Dara aralığı	-60 kg
OIML sınıfı	III

Fiziksel parametreler	
Display	LCD (aydınlatma ile)
Tartım kefesi boyutları	500×700 mm
Ambalaj boyutları	730×800×270 mm
Net ağırlık	23,4 kg
Brüt ağırlık	27,2 kg
Konstrüksiyon	
IP Sınıfı	IP 65 konstrüksiyon, IP 43 terminal
Konstrüksiyon	toz kaplı çelik St3S
Tartım kefesi	Paslanmaz çelik AISI304
Haberleşme arayüzler	
Haberleşme arayüzü	RS232
Opsiyonel arayüzler	RS232
Elektrik parametreleri	
Güç kaynağı	100 – 240 V AC 50/60 Hz + batarya
Maksimum güç tüketimi	5 W
Batarya ile çalışma süresi	max 8h
Çevresel koşullar	
Çalıştırma sıcaklığı	-10 – +40 °C
Depolama sıcaklığı	-10 – +50 °C
Atmosferik nem	10% – 85% RH yoğunlaşma yok
İndikatör	C315



Extra payment for verification



Aksesuarlar

Güç adaptörü
RS 232 cables (scale - printer)
Çakmak prizine uygun besleme kabloları
Display
Display
RS 232, RS 485 cables
Antivibrasyon masaları
RS 232 – Ethernet Converter

AP2-1 Güç döngüsü çıkışı
RS 232, RS 485 Kabloları
RS 232 – USB Converter
Kablolar RS 232 (Teraziler - Yazıcı)
RS 232 – RS 485 Converter
Fiş yazıcı
Tartım terminalleri için tutucular

Yazılım

• RAD Key [WX-010-0005]
• R-Lab [WX-010-0080]

• R Panel [WX-010-0187]
• Terazi Editörü - EWAG 2.1 [WX-010-0173]

Cihaz boyutları



C315.C2.R



C315.C2.K



C315.C3.M

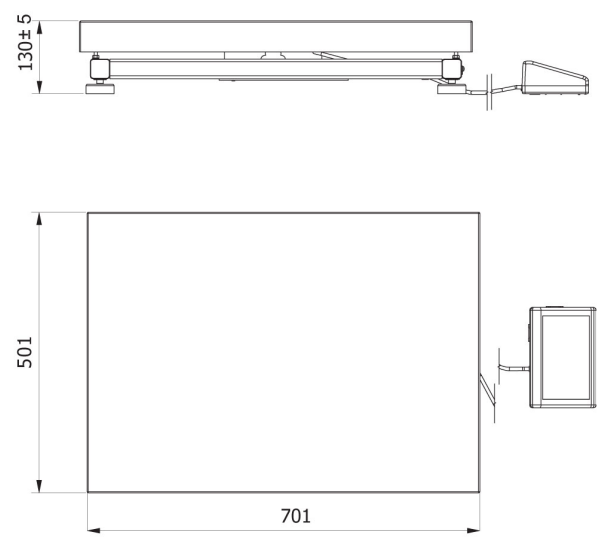

C315.C3.K