

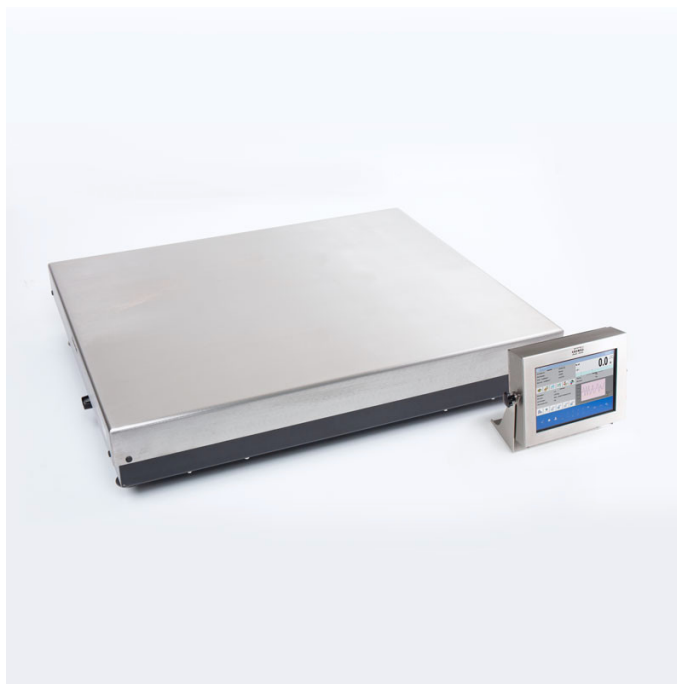

More information on the website
radwag.com/it/info,w1,SI3

HY10.150.1.HRP.M2.1 Basamenti ad alta risoluzione



The drawings, photos and graphics used are for illustrative purposes only.

funzioni

-  Dosing
-  Labelling
-  Plus/Minus Control
-  Percent Weighing
-  Totalizing
-  Parts counting
-  Peak hold
-  Formulation
-  Newton unit measurement
-  Statistics
-  Checkweighing
-  GLP Procedures
-  Animal weighing
-  Differential weighing
-  Replaceable unit
-  Statistical Quality Control
-  ALIBI Memory
-  Transactions

Foglio di calcolo

Parametri metrologici	
Capacità massima [Max]	150 kg
Pesata minima	50 g
Intervallo di precarico	30 kg
Accuratezza	1 g

Parametri metrologici	
Intervallo di verifica della bilancia [e]	10 g
Intervallo di tara	-150 kg
Ripetibilita	1,5 g
Linearita	±3 g
Tempo di stabilizzazione	3 s
Calibrazione	internal (automatic)
Classe OIML	II
Quantita massima di unita verificate	15000 e
Parametri fisici	
Display	10" graphic colour touchscreen
Dimensioni del piatto di pesata	800x600 mm
Dimensioni del pacco	800x1000x537 mm
Peso netto	71,5 kg
Peso lordo	119 kg
Costruzione	
Punteggio IP	IP 66/67 construction, IP 68/69 indicator
Costruzione	mild steel St3S
Materiale da pesata	Stainless steel AISI304
Interfaccia di comunicazione	
Interfaccia	2xRS232, 2xUSB-A, Ethernet, 4 IN / 4 OUT (digital)
Interfacce opzionali	module Wi-Fi 802.11 b/g/n, module Profibus (DP SLAVE), module RS485, module PROFINET (RJ45), analog output module (4-20mA, 0-20mA, 0-10V) , 12IN / 12OUT (IN – 5-24 VDC, OUT – max 30 VDC, 0,5 ADC)
Parametri elettrici	
Alimentatore	100 – 240 V AC 50/60 Hz
Environmental conditions	
Temperatura di lavoro	+10 ÷ +40 °C
Umidita atmosferica	40% ÷ 80%

* Wi-Fi® is a registered trademark of Wi-Fi® Alliance.



Extra payment for verification



Accessori

Cavo seriale RS 232 (connessione bilance - Stampanti)
 Lettore di tessere transponder
 Cavo seriale RS 232 (connessione bilance - Stampanti ZEBRA)
 Cavo seriale RS 232 (connessione bilance - Ethernet)
 Display
 Cavo seriale RS 232, RS 485
 cavi IN/OUT
 Lettore di codici a barre

stampanti per etichette
 Supporto, set di montaggio a muro e braccetti di montaggio
 Tastiera, interruttori esterni
 Stampanti di ricevuata
 cavo USB (connessione bilance - stampanti)
 Moduli aggiuntivi della piattaforma
 Moduli aggiuntivi
 RS 232 – USB Converter

Software

- E2R Weighing [WX-010-0099]
- E2R Weighing Records [WX-010-0038]
- Audit Trail Reader [WX-010-0186]
- RADWAG Remote Desktop [WX-010-0107]
- Editore per sistemi di pesatura 2.1 [WX-010-0173]
- E2R Formulazione [WX-010-0043]
- RAD Key [WX-010-0005]
- Editore di etichette R02 [WX-010-0094]
- R-LAB [WX-010-0080]
- Software „Development Studio” RADWAG [WX-010-0104]

Device dimensions



HY10.16 - 32.HRP



HY10.HRP

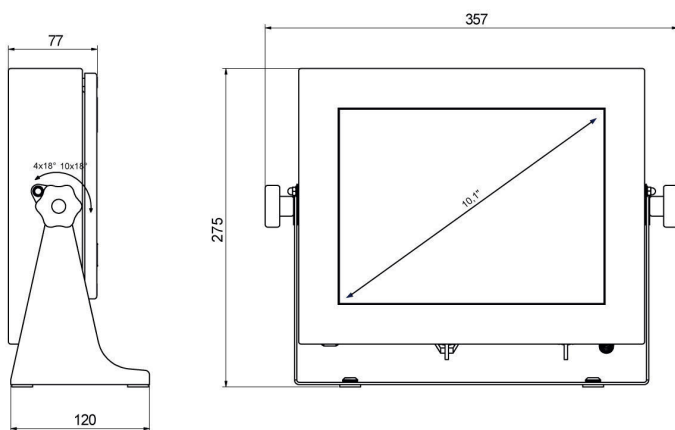

PUE HY10

Scale type	A1	A2	H
HY10.(16-32).HRP	360	280	180±5
HY10.(62-150).HRP	500	400	180±5
HY10.150.2.HRP	500	500	180±5
HY10.(150.1-300).HRP	800	600	180±5
HY10.(300.1-1100).HRP	1000	800	180±5
HY10.(2000).HRP	1250	1000	180±5

Dimensions in mm