



More information on the website
radwag.com/it/info,w1,RAX

Bilancia multifunzione C32.3.F1.R



The drawings, photos and graphics used are for illustrative purposes only.

Funzioni



Labelling



Plus/Minus Control



Percent Weighing



Totalizing



Parts counting



Newton unit measurement



Statistics



IR sensors



GLP Procedures



Replaceable unit



ALIBI Memory

Specifiche

| Parametri metrologici | |
|--|-------|
| Portata massima [Max] | 3 kg |
| Portata minima [Min] | 20 g |
| Divisione [d] | 1 g |
| Campo di tara | -3 kg |
| Massima leggibilità per bilance non verificate | 0,2 g |
| Classe OIML | III |

| Parametri fisici | |
|--------------------------------|--|
| Sistema di livellamento | manual |
| Display | 5" graphic colour |
| Dimensione piatto | 300×300 mm |
| Dimensioni del pacco | 570×390×170 mm |
| Peso netto | 5,3 kg |
| Peso lordo | 6,1 kg |
| Costruzione | |
| Punteggio IP | IP 65 construction, IP 43 terminal |
| Costruzione | mild steel St3S |
| Materiale da pesata | Stainless steel AISI304 |
| Interfaccia di comunicazione | |
| Interfaccia | 2×RS232, USB-A, USB-B, Ethernet, 4 IN / 4 OUT (digital), Wi-Fi |
| Parametri elettrici | |
| Alimentatore | 100 – 240 V AC 50/60 Hz |
| Massimo assorbimento elettrico | 10 W |
| Alimentatore opzionale | internal rechargeable battery |
| Tempo operativo delle batterie | operation time up to 5 h |
| Environmental conditions | |
| Ambiente di lavoro | -10 – +40 °C |

* Equipaggiamento opzionale a pagamento

* Wi-Fi® is a registered trademark of Wi-Fi® Alliance.



Extra payment for verification



Accessori

Display
 Alimentatore
 Cavo seriale RS 232 (connessione bilance - Stampanti)
 Cavo di alimentazione con spina per accendisigari
 Lettore di codici a barre
 Cavo seriale RS 232, RS 485
 stampanti per etichette
 Display

Display
 Tastiera, interruttori esterni
 Supporto, set di montaggio a muro e braccetti di montaggio
 Moduli aggiuntivi
 Stampanti di ricevuta
 Cavo seriale RS 232, RS 485
 Cavo seriale RS 232 (connessione bilance - Stampanti)

Software

- E2R Weighing [WX-010-0099]
- RAD Key [WX-010-0005]
- „Alibi Reader” PC Software [WX-010-0114]
- Editore per sistemi di pesatura 2.1 [WX-010-0173]

- E2R Weighing Records [WX-010-0038]
- Editore di etichette R02 [WX-010-0094]
- R-LAB [WX-010-0080]
- Software „Development Studio” RADWAG [WX-010-0104]

Device dimensions

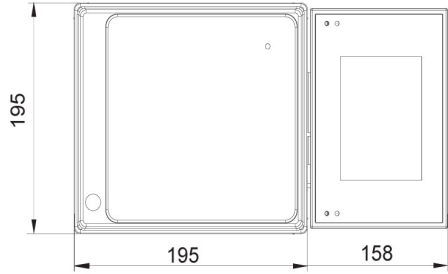
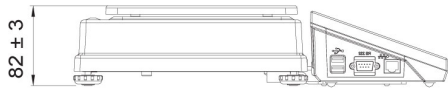

C32.D2

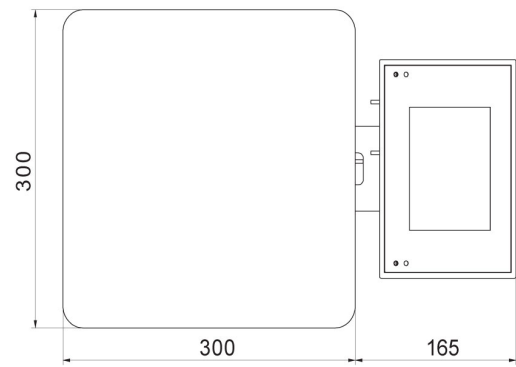
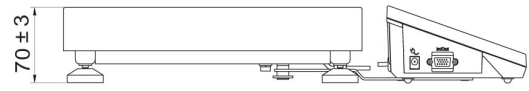

C32.F1.R

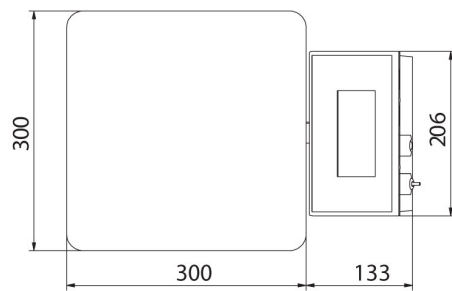
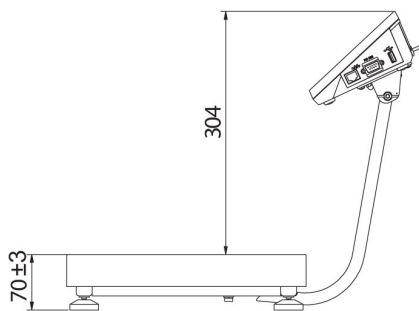

C32.F1.M

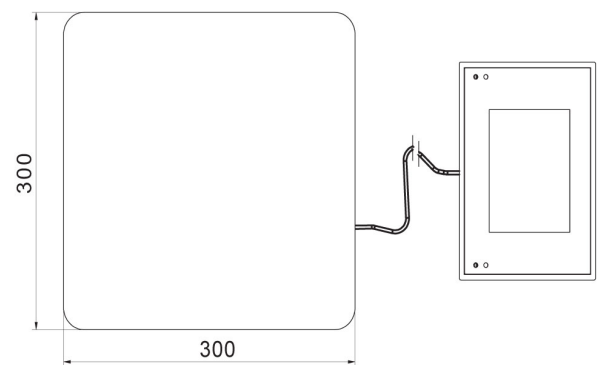
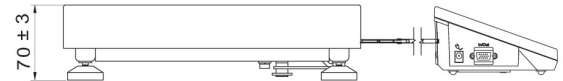

C32.F1.K