



More information on the website  
[radwag.com/en/info,w1,RAX](http://radwag.com/en/info,w1,RAX)

# C32.3.F1.R Multifunctional Scale



The drawings, photos and graphics used are for illustrative purposes only.

## Functions



Labelling



Plus/Minus Control



Percent Weighing



Totalizing



Parts counting



Newton unit measurement



Statistics



IR sensors



GLP Procedures



Replaceable unit



ALIBI Memory

## Datasheet

Metrological parameters	
Maximum capacity [Max]	3 kg
Minimum load	20 g
Readability [d]	1 g
Tare range	-3 kg
Max readability for non-verified scale	0.2 g
OIML Class	III

Physical parameters	
Leveling system	manual
Display	5" graphic colour
Weighing pan dimensions	300×300 mm
Packaging dimensions	570×390×170 mm
Net weight	5.3 kg
Gross weight	6.1 kg
Construction	
Protection class	IP 65 construction, IP 43 terminal
Construction	mild steel St3S
Weighing pan material	Stainless steel AISI304
Communication interface	
Communication interface	2×RS232, USB-A, USB-B, Ethernet, 4 IN / 4 OUT (digital), Wi-Fi
Electrical parameters	
Power supply	100 – 240 V AC 50/60 Hz
Power consumption max.	10 W
Optional power supply	internal rechargeable battery
Operation time on batteries	operation time up to 5 h
Environmental conditions	
Operating temperature	-10 – +40 °C

\* Optional equipment at additional cost

\* Wi-Fi® is a registered trademark of Wi-Fi® Alliance.



Extra payment for verification



## Accessories

Displays

Power Adapters

RS 232 cables (scale - printer)

Cigarette lighter receptacle power supply cables

Barcode scanners

RS 232, RS 485 cables

Label Printers

Displays

Displays

Keypad, external switches

Stands, wall mounting kits and mounting brackets

Additional modules

Receipt Printer

RS 232, RS 485 cables

RS 232 cables (scale - printer)

## Software

- E2R Weighing [WX-010-0099]
- RAD Key [WX-010-0005]
- Alibi Reader [WX-010-0114]
- Scale Editor 2.1 [WX-010-0173]

- E2R Weighing Records [WX-010-0038]
- Label Editor R02 [WX-010-0094]
- R-Lab [WX-010-0080]
- RADWAG Development Studio [WX-010-0104]

# Device dimensions

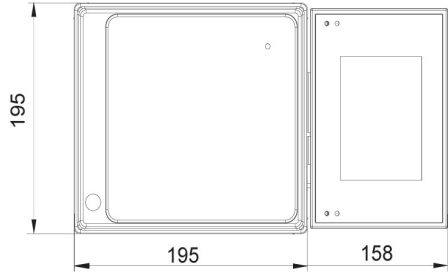
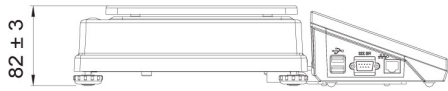

C32.D2

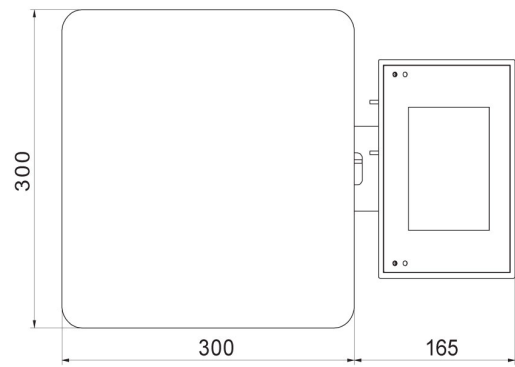
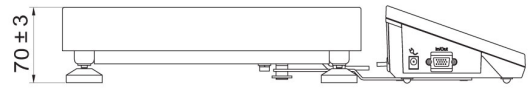

C32.F1.R

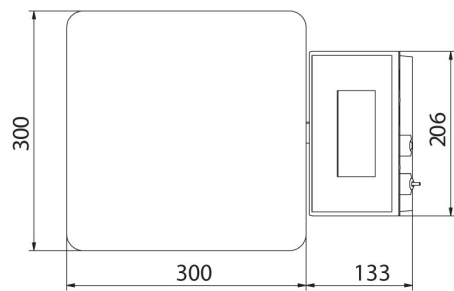
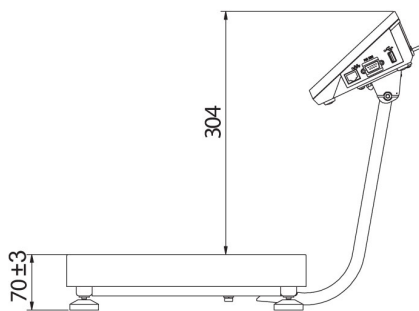

C32.F1.M

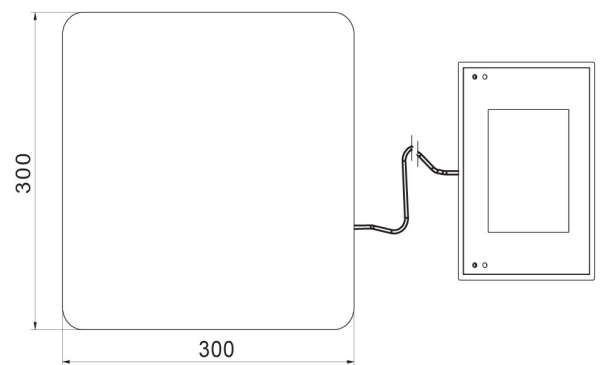
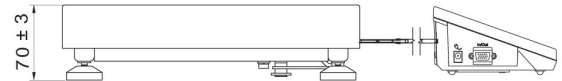

C32.F1.K