



More information on the website
radwag.com/tr/info,w1,R80

C315.30/60.C2.K Yük Hücreli Platform Terazi



The drawings, photos and graphics used are for illustrative purposes only.

Fonksiyonlar

 Plus/Minus Control

 Percent Weighing

 Totalizing

 Parts counting

 Internal battery

 Peak hold

 Newton unit measurement

 GLP Procedures

 Animal weighing

 ALIBI Memory

Teknik Veriler

Metrolojik parametreler	
Maksimum yük [Max]	30/60 kg
Minimum yük [Min]	200 g
Okuma up doğruluğu [d]	10/20 g
Yasallaştırma birimi [e]	10/20 g
Dara aralığı	-60 kg
OIML sınıfı	III

Fiziksel parametreler	
Display	LCD (backlit)
Tartım kefesi boyutları	400×500 mm
Ambalaj boyutları	720×620×210 mm
Net ağırlık	12,5 kg
Brüt ağırlık	15 kg
Kablo uzunluğu	2,5 m
İndikatör	C315
Konstrüksiyon	
IP Sınıfı	IP 65 construction, IP 43 indicator
Konstrüksiyon	mild steel St3S
Tartım kefesi	Stainless steel AISI304
Haberleşme arayüzler	
Haberleşme arayüzü	RS232
Opsiyonel arayüzler	RS232
Elektrik parametreleri	
Güç kaynağı	100 – 240 V AC 50/60 Hz and battery
Maksimum güç tüketimi	5 W
Batarya ile çalışma süresi	max 8h
Çevresel koşullar	
Çalıştırma sıcaklığı	-10 ÷ +40 °C
Depolama sıcaklığı	-10 ÷ +50 °C
Atmosferik nem	10% ÷ 85% RH no condensation



Extra payment for verification



Aksesuarlar

Antivibrasyon masaları
Güç adaptörü
RS 232 cables (scale - printer)
Tartım terminalleri için tutucular
Çakmak prizine uygun besleme kabloları
Display
Display
RS 232, RS 485 cables

RS 232 – Ethernet Converter
AP2-1 Güç döngüsü çıkışı
RS 232, RS 485 Kabloları
RS 232 – USB Converter
Kablolar RS 232 (Teraziler - Yazıcı)
RS 232 – RS 485 Converter
Fiş yazıcı

Yazılım

• RAD Key [WX-010-0005]
• R-Lab [WX-010-0080]

• R Panel [WX-010-0187]
• Terazi Editörü - EWAG 2.1 [WX-010-0173]

Cihaz boyutları

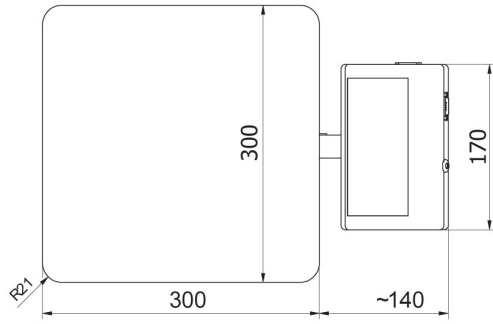

C315.F1.M

C315.F1.R



C315.C2.M

C315.C2.K



C315.C2.R



C315.C2.K



C315.C3.M



C315.C3.K

