



More information on the website
radwag.com/it/info,w1,R80

Basamento a cella di carico C315.30/60.C2.K



The drawings, photos and graphics used are for illustrative purposes only.

funzioni

 Plus/Minus Control

 Percent Weighing

 Totalizing

 Parts counting

 Internal battery

 Peak hold

 Newton unit measurement

 GLP Procedures

 Animal weighing

 ALIBI Memory

Foglio di calcolo

Parametri metrologici	
Capacità massima [Max]	30/60 kg
Pesata minima	200 g
Accuratezza	10/20 g
Intervallo di verifica della bilancia [e]	10/20 g
Intervallo di tara	-60 kg
Classe OIML	III

Parametri fisici	
Display	LCD (backlit)
Dimensioni del piatto di pesata	400×500 mm
Dimensioni del pacco	720×620×210 mm
Peso netto	12,5 kg
Peso lordo	15 kg
Lunghezza del cavo	2,5 m
Indicatore	C315
Costruzione	
Punteggio IP	IP 65 construction, IP 43 indicator
Costruzione	mild steel St3S
Materiale da pesata	Stainless steel AISI304
Interfaccia di comunicazione	
Interfaccia	RS232
Interfacce opzionali	RS232
Parametri elettrici	
Alimentatore	100 – 240 V AC 50/60 Hz and battery
Massimo assorbimento elettrico	5 W
Tempo operativo delle batterie	max 8h
Environmental conditions	
Temperatura di lavoro	-10 ÷ +40 °C
Temperatura di stoccaggio	-10 ÷ +50 °C
Umidità atmosferica	10% ÷ 85% RH no condensation



Extra payment for verification



Accessori

Tavoli antivibranti
 Alimentatore
 Cavo seriale RS 232 (connessione bilance - Stampanti)
 Supporto, set di montaggio a muro e braccetti di montaggio
 Cavo di alimentazione con spina per accendisigari
 Display
 Display
 Cavo seriale RS 232, RS 485

RS 232 – Ethernet Converter
 AP2-1 Power loop output
 Cavo seriale RS 232, RS 485
 RS 232 – USB Converter
 Cavo seriale RS 232 (connessione bilance - Stampanti)
 RS 232 – RS 485 Converter
 Stampanti di ricevuta

Software

- RAD Key [WX-010-0005]
- R-LAB [WX-010-0080]
- R Panel [WX-010-0187]
- Editore per sistemi di pesatura 2.1 [WX-010-0173]

Device dimensions

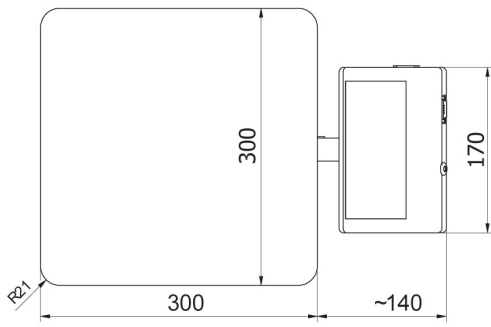

C315.F1.M

C315.F1.R



C315.C2.M

C315.C2.K

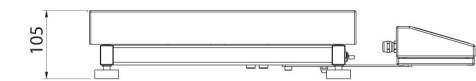

C315.C2.R

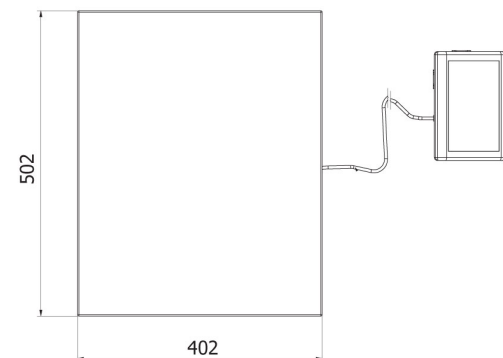
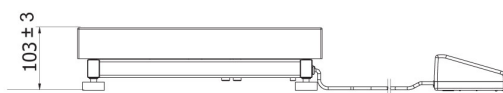

C315.C2.K

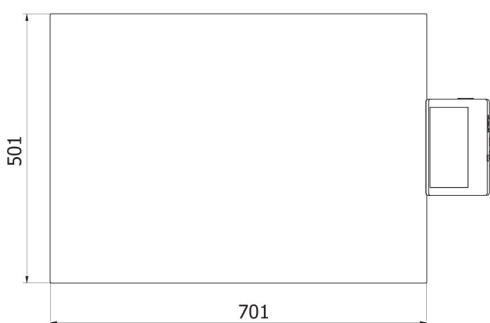

C315.C3.M

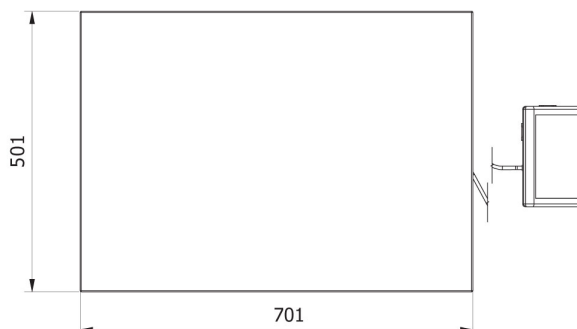
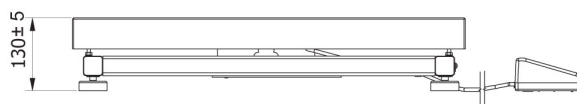

C315.C3.K