



More information on the website
radwag.com/fr/info,w1,R80

Balance mono capteur C315.30/60.C2.K



The drawings, photos and graphics used are for illustrative purposes only.

Fonctions

 Plus/Minus Control

 Percent Weighing

 Totalizing

 Parts counting

 Internal battery

 Peak hold

 Newton unit measurement

 GLP Procedures

 Animal weighing

 ALIBI Memory

Paramètres Techniques

Paramètres métrologiques	
Capacité maximale [Max]	30 / 60 kg
Capacité minimale [Min]	200 g
Précision de lecture	10 / 20 g
Échelon de légalisation [e]	10 / 20 g
Étendue de tare	-60 kg
Classe de précision OIML	III

Paramètres physiques	
Afficheur	LCD (rétro-éclairé)
Longueur de câble	2,5 m
Dimension du plateau	400×500 mm
Dimensions de colis	720×620×210 mm
Masse nette	12,5 kg
Masse brute	15 kg
Construction	
Degré de protection	IP 65 construction, IP 43 terminal
Construction	acier pulvériséacier St3S
Matériel du plateau	Acier inoxydable AISI304
Interface de Communication	
Interface de Communication	RS232
Interfaces optionnelles	RS232
Paramètres électriques	
Alimentation	100 – 240 V AC 50/60 Hz + accumulateur
Prise de courant maximale	5 W
Temps de travail avec l'alimentation d'accumulateur	max 8h
Conditions environnementales	
Température du travail	-10 – +40 °C
Température de stockage	-10 – +50 °C
Humidité relative d'air	10% – 85% RH sans condensation
Terminal	C315



Extra payment for verification



Accessoires

Tables antivibratoires
 Alimentateurs
 Câbles RS 232 (balance – imprimante)
 Supports, Statifs, bras-supports
 Câbles d'alimentation de cigare-allume
 Afficheurs
 Afficheurs
 Câbles RS 232, RS 485

Convertisseur RS 232 – Ethernet
 Sorties de boucle de courant AP2-1
 Câbles RS 232, RS 485
 Convertisseur RS 232 – USB
 Câbles RS 232 (balance – imprimante)
 Convertisseur RS 232 – RS 485
 Imprimante de tickets de caisse

Software

• RAD Key [WX-010-0005]
 • R-LAB [WX-010-0080]

• R Panel [WX-010-0187]
 • Éditeur de Balances 2.1 [WX-010-0173]

Dimensions d'appareil

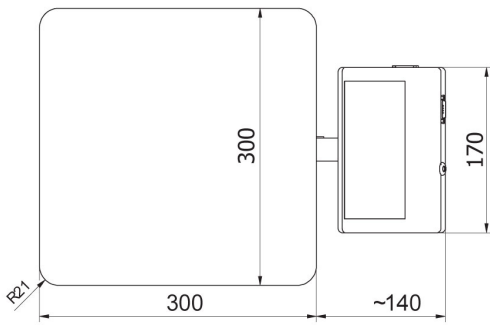

C315.F1.M

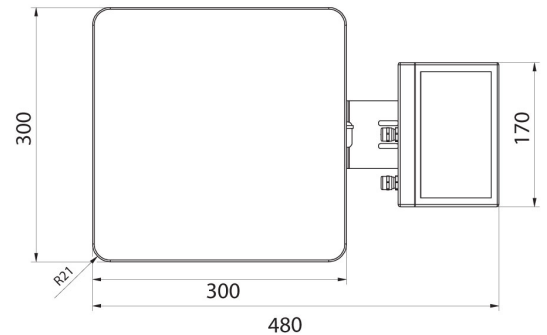
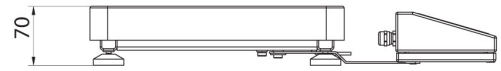

C315.F1.R

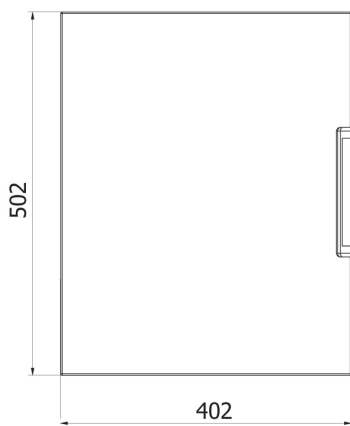

C315.C2.M

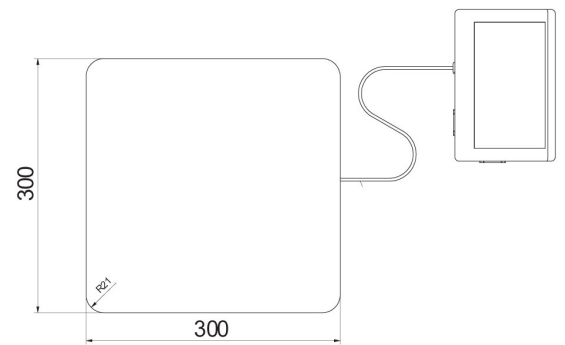
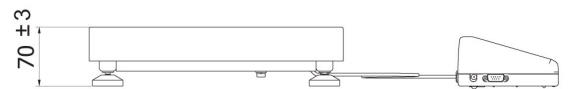

C315.C2.K



C315.C2.R



C315.C2.K



C315.C3.M

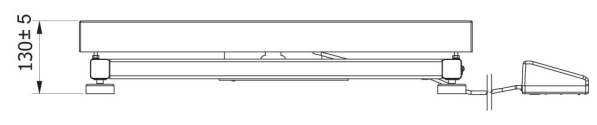

C315.C3.K

