





















More information on the website  
[radwag.com/de/info,w1,R44](http://radwag.com/de/info,w1,R44)

# Waage mit hoher Auflösung HY10.120.HRP.H.M2.1



The drawings, photos and graphics used are for illustrative purposes only.

## Funktionen

-  Dosing
-  Labelling
-  Plus/Minus Control
-  Percent Weighing
-  Totalizing
-  Parts counting
-  Peak hold
-  Formulation
-  Newton unit measurement
-  Statistics
-  Checkweighing
-  GLP Procedures
-  Animal weighing
-  Differential weighing
-  Replaceable unit
-  Statistical Quality Control
-  ALIBI Memory
-  Transactions

## Technische Daten

Messtechnische Parameter	
Wägebereich [Max]	120 kg
Min. Belastung	50 g
Vorlast	30 kg
Ziffernschritt [d]	1 g

Messtechnische Parameter	
Eichwert [e]	10 g
Tarierbereich	-120 kg
Wiederholbarkeit	1 g
Linearität	±2 g
Stabilisierungszeit	3 s
Justierung	intern (automatisch)
OIML-Klasse	II
Max. Anzahl der Eichwerte	12000 e
Physikalische Parameter	
Display	10" grafisch farbiger Touch-Screen
Waagschale	500×400 mm
Verpackungsgröße	610×710×505 mm
Nettogewicht	37 kg
Bruttogewicht	52 kg
Konstruktion	
Schutzart	IP 66/67 Konstruktion, IP 68/69 Messgerät
Konstruktion	Edelstahl AISI304
Waageschale	Edelstahl AISI304
Kommunikationsschnittstellen	
Schnittstellen	2×RS232, 2×USB-A, Ethernet, 4 IN / 4 OUT (digital)
Optionale Schnittstellen	Modul Wi-Fi 802.11 b/g/n, Modul Profibus (DP SLAVE), Modul RS485, Modul PROFINET (RJ45), Modul analoge Ausgänge (4-20mA, 0-20mA, 0-10V) , 12IN / 12OUT (IN – 5-24 VDC, OUT – max 30 VDC, 0,5 ADC)
Elektrische Parameter	
Stromversorgung	100 – 240 V AC 50/60 Hz
Umgebungsbedingungen	
Umgebungstemperatur	+10 ÷ +40 °C
Relative Luftfeuchtigkeit	40% ÷ 80%

**Wiederholbarkeit** wird als Standardabweichung von 10 Wägezyklen ausgedrückt.

**Relative Luftfeuchtigkeit** unter nicht kondensierenden Bedingungen.

**Stabilisierungszeit** unter optimalen Umgebungsbedingungen.

\* Wi-Fi® is a registered trademark of Wi-Fi® Alliance.



Extra payment for verification



## Zubehör

Kabel RS 232 (Waage – Drucker)  
 Transponderkartenleser  
 Kabel RS 232 (Waage – Drucker ZEBRA)  
 Netzkabel (Waage – Ethernet)  
 Displays  
 Kabel RS 232, RS 485  
 E/A Kabel  
 Barcodescanner

Etikettendrucker  
 Stative, Ausleger  
 Tastaturen, Taster  
 Thermische Drucker  
 USB-Kabel (Waage – Drucker)  
 Modul für zusätzliche Wägeplattformen  
 Zusätzliche Module  
 Konverter RS 232 – USB

## Software

- E2R Wägung [WX-010-0099]
- E2R Evidenz [WX-010-0038]
- Audit Trail Reader [WX-010-0186]
- Radwag Remote Desktop [WX-010-0107]
- Scale Editor 2.1 [WX-010-0173]
- E2R Rezepturen [WX-010-0043]
- RAD Key [WX-010-0005]
- Etiketten-Editor R02 [WX-010-0094]
- RLAB [WX-010-0080]
- RADWAG Development Studio [WX-010-0104]

## Abmessungen des Geräts



HY10.16 - 32.HRP.H

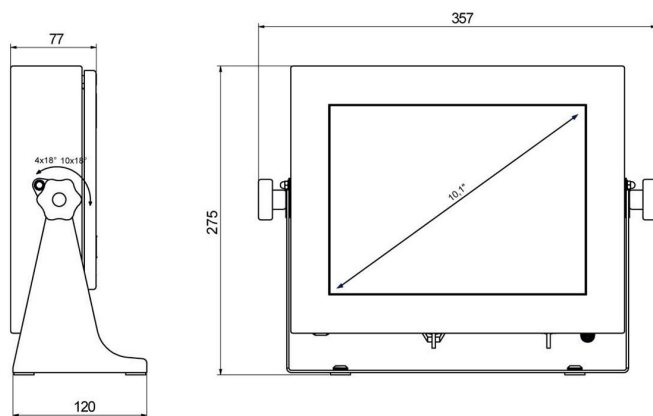

PUE HY10

Scale type	A1	A2	H
HY10.(16-32).HRP.H	360	280	180±5
HY10.(62-150).HRP.H	500	400	180±5
HY10.150.2.HRP.H	500	500	180±5
HY10.(150.1-300).HRP.H	800	600	180±5
HY10.(300.1-1100).HRP.H	1000	800	180±5
HY10.(2000).HRP.H	1250	1000	180±5

Dimensions in mm