

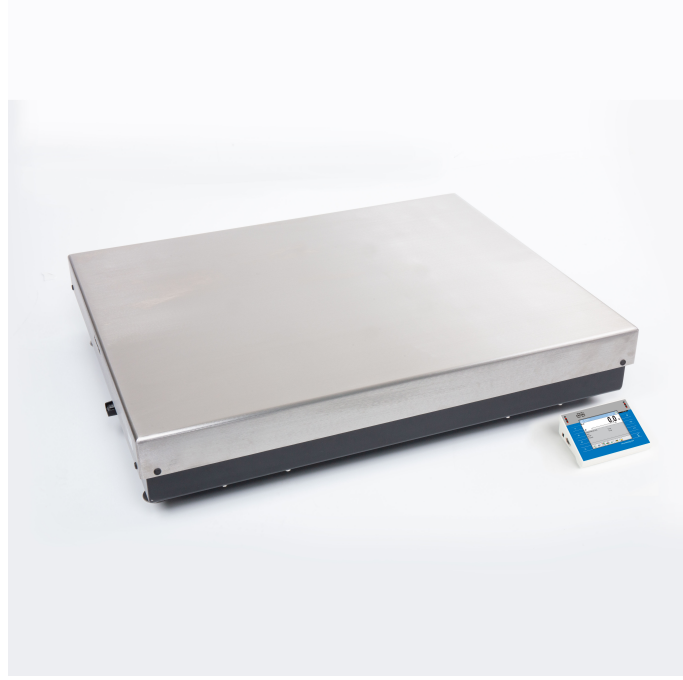

More information on the website
radwag.com/tr/info,w1,R3H

PUE 7.1.300.HRP Yüksek Çözünürlüklü Terazi



The drawings, photos and graphics used are for illustrative purposes only.

Teknik Veriler

Metrolojik parametreler	
Maksimum yük [Max]	300 kg
Minimum yük [Min]	50 g
Ön yük	60 kg
Okuma up doğruluğu [d]	1 g
Dara aralığı	-300 kg
Tekrarlanabilirlik	3 g
Doğrusallık	±6 g
Kararlılık süresi	3 s
Ayarlama	internal (automatic)
Fiziksel parametreler	
Display	5,7" Resistiv-Farb-Touchscreen
Tartım kefi boyutları	800×600 mm
Cihaz boyutları	360×313×170 mm
Ambalaj boyutları	800×1000×437 mm
Net ağırlık	71,5 kg

Fiziksel parametreler	
Brüt ağırlık	90 kg
Konstrüksiyon	
IP Sınıfı	IP 66/67 construction, IP 43 indicator
Konstrüksiyon	mild steel St3S
Tartım kefesi	Stainless steel AISI304
Haberleşme arayüzler	
Haberleşme arayüzü	2×RS232, 2×USB-A, Ethernet, 4 IN / 4 OUT (digital), Wi-Fi
Elektrik parametreleri	
Güç kaynağı	100 – 240 V AC 50/60 Hz
Çevresel koşullar	
Çalıştırma sıcaklığı	+10 ÷ +40 °C
Atmosferik nem	40% ÷ 80%

* Wi-Fi® is a registered trademark of Wi-Fi® Alliance.



Aksesuarlar

Display
Transponder kart okuyucular
RS 232 cables (scale - Ethernet)
RS 232 cables (scale - printer)
Barkod okuyucu

Etiket Yazıcısı
Fiş yazıcı
Modülleri ek platformları
RS 232 – USB Converter

Yazılım

- E2R Tartım [WX-010-0099]
- RAD Key [WX-010-0005]
- RADWAG Remote Desktop [WX-010-0107]
- Terazi Editörü - EWAG 2.1 [WX-010-0173]

- E2R Tartı Kayıtları [WX-010-0038]
- Etiket Editörü R02 [WX-010-0094]
- R-Lab [WX-010-0080]
- RADWAG Development Studio [WX-010-0104]

Cihaz boyutları

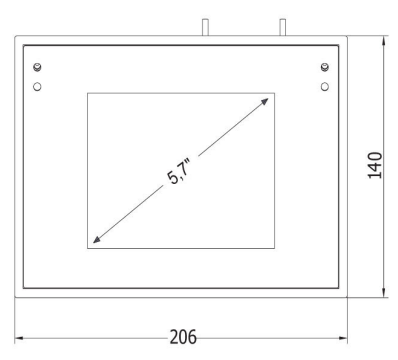
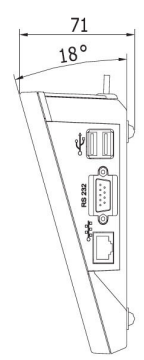
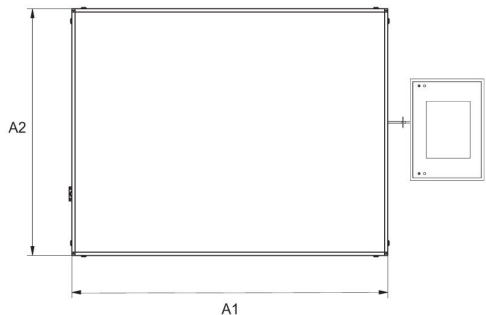
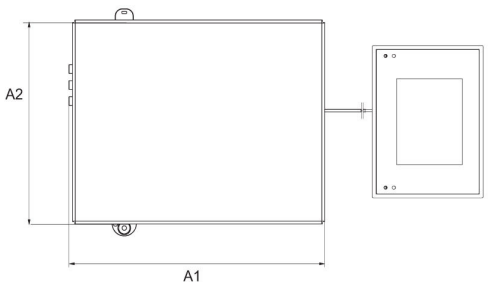
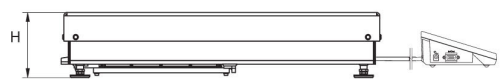
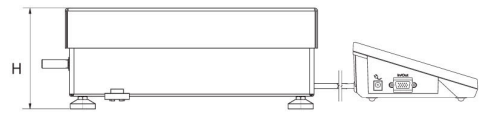

Scale type	A1	A2	H
PUE7.1.16 - 32.HRP	360	280	139±3
PUE7.1.62 - 120.HRP	500	500	175±3
PUE7.1.150 - 300.HRP	800	600	175±3
PUE7.1.300.1 - 1100.HRP	1000	800	175±3
PUE7.1.2000.HRP	1250	1000	175±3

dimensions in mm