



More information on the website
radwag.com/it/info,w1,QWX

HY10.150.2.HRP.H Basamenti ad alta risoluzione

WP-340-1018



The drawings, photos and graphics used are for illustrative purposes only.

Funzioni

-  Dosing
-  Labelling
-  Plus/Minus Control
-  Percent Weighing
-  Totalizing
-  Parts counting
-  Peak hold
-  Formulation
-  Newton unit measurement
-  Statistics
-  Checkweighing
-  GLP Procedures
-  Animal weighing
-  Differential weighing
-  Replaceable unit
-  Statistical Quality Control
-  ALIBI Memory
-  Transactions

Specifiche

| Parametri metrologici | |
|-------------------------|--------|
| Portata massima [Max] | 150 kg |
| Portata minima [Min] | 50 g |
| Intervallo di precarico | 30 kg |

| Parametri metrologici | |
|------------------------------|---|
| Divisione [d] | 1 g |
| Campo di tara | -150 kg |
| Ripetibilità | 0,6 g |
| Linearità | ±3 g |
| Tempo di stabilizzazione | 3 s |
| Calibrazione | internal (automatic) |
| Parametri fisici | |
| Display | 10,1" graphic colour touchscreen |
| Dimensione piatto | 500×500 mm |
| Dimensioni del pacco | 1000×800×307 mm |
| Peso net | 71,5 kg |
| Peso lordo | 119 kg |
| Costruzione | |
| Punteggio IP | IP 66 / 67 construction, IP 66 / 67 / 69 terminal |
| Costruzione | Stainless steel AISI304 |
| Materiale da pesata | Stainless steel AISI304 |
| Interfaccia di comunicazione | |
| Interfaccia | 2×RS232, 2×USB-A, Ethernet, 4 IN / 4 OUT (digital) |
| Interfacce opzionali | module Wi-Fi 802.11 b/g/n, module Profibus (DP SLAVE), module RS485, module PROFINET (RJ45), analog output module (4-20mA, 0-20mA, 0-10V) , 12IN / 12OUT (IN – 5-24 VDC, OUT – max 30 VDC, 0,5 ADC) |
| Parametri elettrici | |
| Alimentatore | 100 – 240 V AC 50/60 Hz |
| Environmental conditions | |
| Ambiente di lavoro | +10 – +40 °C |
| Umidità relativa | 15% – 80% |

La ripetibilità è espressa come deviazione standard di 10 cariche.

Umidità relativa - in condizioni di non condensazione.

Tempo di stabilizzazione - in condizioni ambientali ottimali.

* Wi-Fi® is a registered trademark of Wi-Fi® Alliance.



Accessori (Additional Fee)

Lettore di tessere transponder
 Cavo seriale RS 232 (connessione bilance - Stampanti ZEBRA)
 Cavo seriale RS 232 (connessione bilance - Stampanti)
 Cavo seriale RS 232 (connessione bilance - Ethernet)
 Display
 Cavo seriale RS 232, RS 485
 cavi IN/OUT

Supporto, set di montaggio a muro e braccetti di montaggio
 Tastiera, interruttori esterni
 Stampanti di ricevuta
 cavo USB (connessione bilance - stampanti)
 Moduli aggiuntivi della piattaforma
 Moduli aggiuntivi

Software (Additional Fee)

- E2R Weighing [WX-010-0099]
- E2R Weighing Records [WX-010-0038]
- Editore di etichette R02 [WX-010-0094]
- Editore per sistemi di pesatura 2.1 [WX-010-0173]
- E2R Formulazione [WX-010-0043]
- Audit Trail Reader [WX-010-0186]
- RADWAG Remote Desktop [WX-010-0107]

Device dimensions

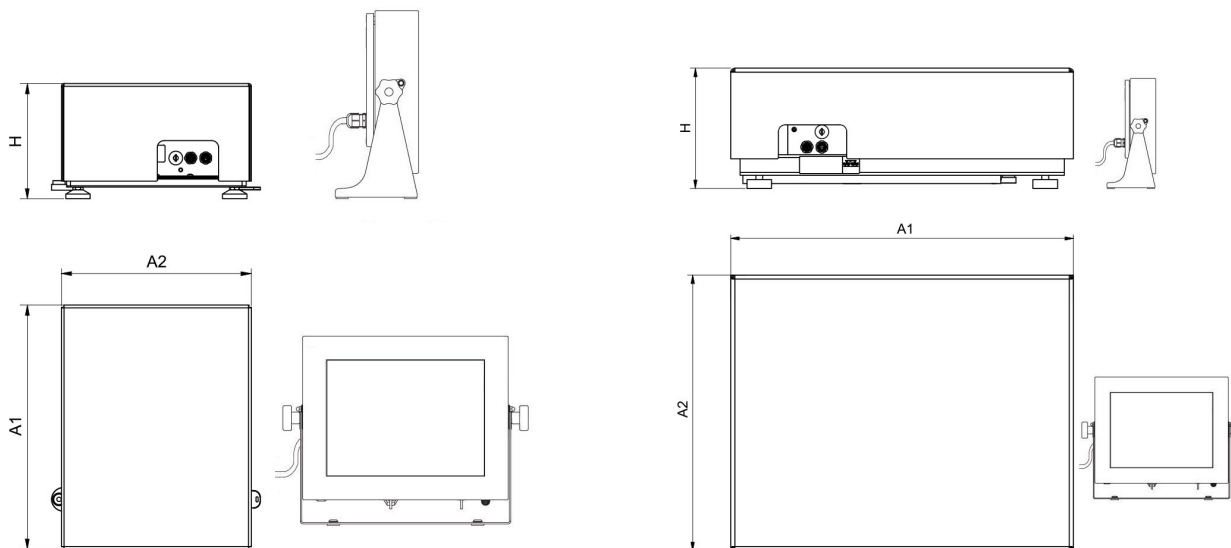

HY10.16 - 32.HRP.H

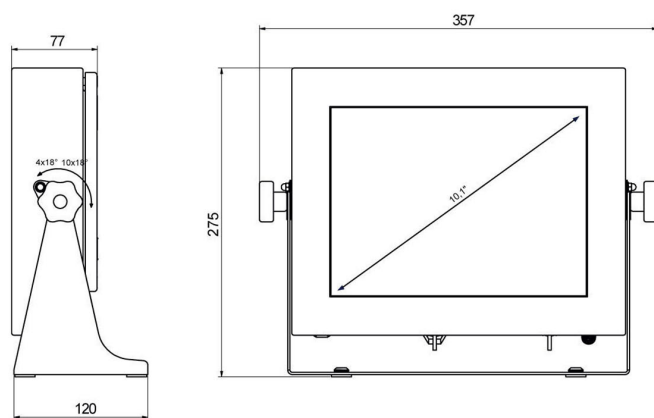

PUE HY10

| Scale type | A1 | A2 | H |
|-------------------------|------|------|-------|
| HY10.(16-32).HRP.H | 360 | 280 | 180±5 |
| HY10.(62-150).HRP.H | 500 | 400 | 180±5 |
| HY10.150.2.HRP.H | 500 | 500 | 180±5 |
| HY10.(150.1-300).HRP.H | 800 | 600 | 180±5 |
| HY10.(300.1-1100).HRP.H | 1000 | 800 | 180±5 |
| HY10.(2000).HRP.H | 1250 | 1000 | 180±5 |

Dimensions in mm