



More information on the website  
[radwag.com/it/info,w1,PQG](http://radwag.com/it/info,w1,PQG)

## Basamento a cella di carico C315.60.C2.R





The drawings, photos and graphics used are for illustrative purposes only.

### Funzioni

 Plus/Minus Control

 Percent Weighing

 Totalizing

 Parts counting

 Internal battery

 Peak hold

 Newton unit measurement

 GLP Procedures

 Animal weighing

 ALIBI Memory

### Specifiche

Parametri metrologici	
Portata massima [Max]	60 kg
Portata minima [Min]	400 g
Divisione [d]	20 g
Intervallo di verifica della bilancia [e]	20 g
Campo di tara	-60 kg
Massima leggibilità per bilance non verificate	2 g
Classe OIML	III

Parametri fisici	
Display	LCD (backlit)
Dimensione piatto	400×500 mm
Dimensioni del pacco	720×620×210 mm
Peso netto	12,5 kg
Peso lordo	13,5 kg
Costruzione	
Punteggio IP	IP 65 construction, IP 43 terminal
Costruzione	mild steel St3S
Materiale da pesata	Stainless steel AISI304
Interfaccia di comunicazione	
Interfaccia	RS232
Interfacce opzionali	RS232
Parametri elettrici	
Alimentatore	100 – 240 V AC 50/60 Hz and battery
Massimo assorbimento elettrico	5 W
Tempo operativo delle batterie	max 8h
Environmental conditions	
Ambiente di lavoro	-10 – +40 °C
Temperatura di stoccaggio	-10 – +50 °C
Umidità relativa	10% – 85% RH no condensation
Indicatore	C315



Extra payment for verification



## Accessori

Tavoli antivibranti  
 Alimentatore  
 Cavo seriale RS 232 (connessione bilance - Stampanti)  
 Cavo di alimentazione con spina per accendisigari  
 Display  
 Display  
 Cavo seriale RS 232, RS 485  
 RS 232 – Ethernet Converter

AP2-1 Power loop output  
 Cavo seriale RS 232, RS 485  
 RS 232 – USB Converter  
 Cavo seriale RS 232 (connessione bilance - Stampanti)  
 RS 232 – RS 485 Converter  
 Stampanti di ricevuta  
 Supporto, set di montaggio a muro e braccetti di montaggio

## Software

- RAD Key [WX-010-0005]
- R-LAB [WX-010-0080]

- R Panel [WX-010-0187]
- Editore per sistemi di pesatura 2.1 [WX-010-0173]

## Device dimensions



C315.C2.R



C315.C2.K



C315.C3.M

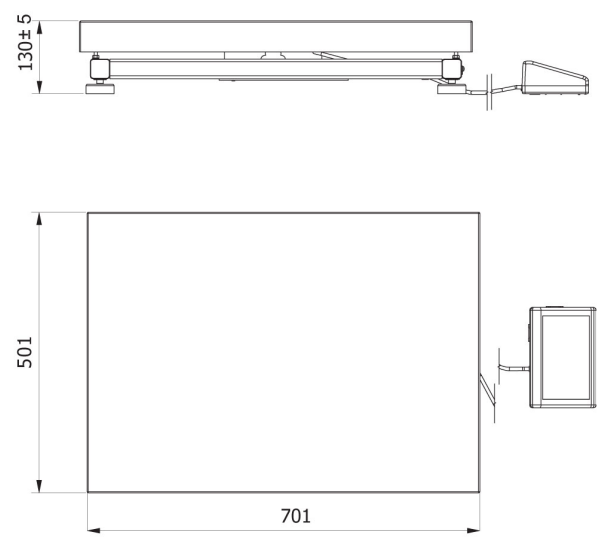

C315.C3.K