



More information on the website  
radwag.com/es/info,w1,P06



















# Báscula multifuncional HY10.15.H2.K

WP-116-0013



The drawings, photos and graphics used are for illustrative purposes only.

## Funciones

-  Dosificación
-  Etiquetado
-  Control más/menos
-  Desviaciones porcentuales
-  Resumiendo pesajes
-  Contar piezas
-  Cierre de la indicación máxima
-  Recetas
-  Medición en Newtons
-  Estadísticas
-  Controlador de peso
-  Procedimientos GLP
-  Pesar animales
-  Pesaje diferencial
-  Unidades intercambiables
-  Control estadístico de calidad
-  Memoria Alibi
-  Transacciones

## Datos técnicos

### Parámetros metrológicos

Maxima capacidad [Max]	15 kg
Minima capacidad	100 g
Legibilidad [d]	5 g
División de legalización [e]	5 g

Parámetros metrológicos	
Rango de tara	-15 kg
Legibilidad máxima para las balanzas no verificadas	1 g
Calibración	externa
Clase OIML	III
Parámetros físicos	
Pantalla	10,1" gráfico color pantalla táctil
Longitud del cable	1,5 m
Dimensión de platillo	250x300 mm
Dimensiones de embalaje	350x560x500 mm
Masa neta	11 kg
Masa bruta	11,5 kg
Construcción	
Grado de protección	IP 66 / 67 construcción, IP 66 / 67 / 69 terminal
Interface de comunicación	
Conectividad	2xRS232, 2xUSB-A, Ethernet, 4 IN / 4 OUT (digitales)
Interfaces opcionales	módulo Wi-Fi 802.11 b/g/n, módulo Profibus (DP SLAVE), módulo RS485, módulo PROFINET (RJ45), módulo de salida analógica (4-20mA, 0-20mA, 0-10V) , 12IN / 12OUT (IN – 5-24 VDC, OUT – max 30 VDC, 0,5 ADC)
Parámetros electricos	
Alimentación	100 – 240 V AC 50/60 Hz
Condiciones ambientales	
Temperatura de trabajo	-10 – +40 °C
Humedad relativa de aire	10% – 85% RH sin condensación

\* Wi-Fi® is a registered trademark of Wi-Fi® Alliance.



Additional fee for verification



## Accesorios (Additional Fee)

Cables RS 232 (Bascula a Impresora)  
 Soportes con transportadores con rollos  
 Lector de tarjetas transpondedor  
 Cables RS 232 (Bascula a Impresora ZEBRA)  
 Cables de corriente (Bascula a Ethernet)  
 Pantallas  
 Cables RS 232, RS 485  
 Cables Entradas/Salidas  
 Escáner de códigos de barra

Impresoras de etiquetas  
 Soportes, brazos  
 Teclado, manipuladores  
 Impresoras de recibos  
 Pesas de clase F1 -  
 cilíndrico sin cámara de ajuste, juegos  
 Cable USB (Bascula a Impresora)  
 Módulos adicionales de la plataforma  
 Módulos adicionales  
 Convertidor RS 232 a USB

## Programas (Additional Fee)

- E2R Pesajes [WX-010-0099]
- E2R CCE [WX-010-0051]

- E2R Recetas [WX-010-0043]
- E2R Registro [WX-010-0038]

- RAD Key [WX-010-0005]
- Editor de Etiquetas R02 [WX-010-0094]
- R-LAB [WX-010-0080]
- RADWAG Development Studio [WX-010-0104]

- Audit Trail Reader [WX-010-0186]
- RADWAG Remote Desktop [WX-010-0107]
- Editor de Balanzas 2.1 [WX-010-0173]

## Dimensiones de aparato

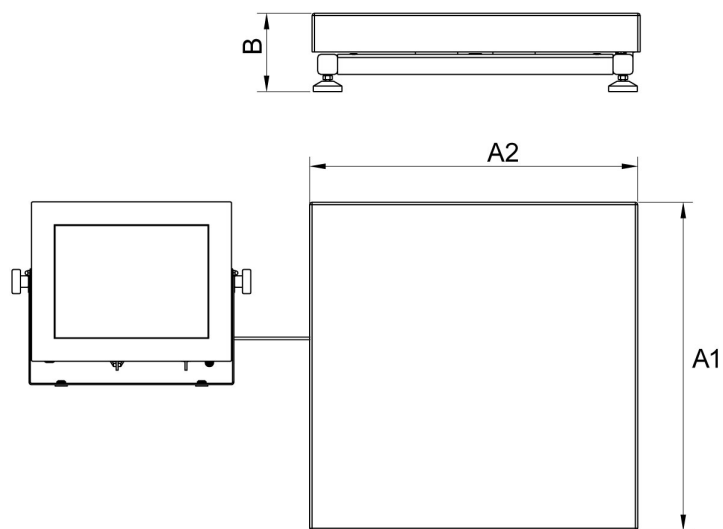

H Platform

Scale type	A1	A2	B
HY10 H1.K	200	150	85 ±3
HY10 H2.K	250	300	103 ±3
HY10 H3.K	410	410	98 ±2
HY10 H4.K	500	500	155 ±5
HY10 H5.K	600	600	155 ±5
HY10 H6.K	800	800	135 ±5

dimensions in mm

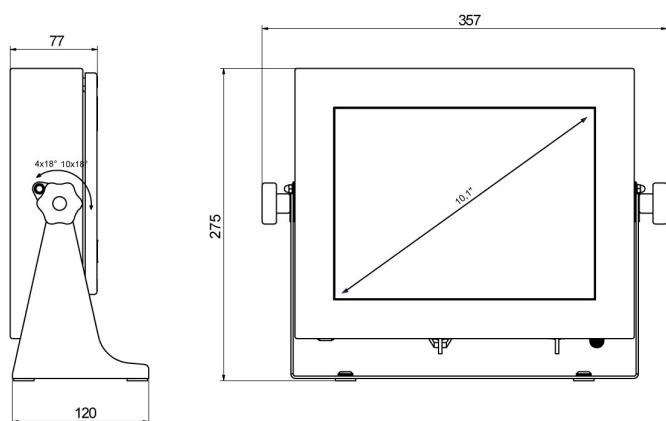

PUE HY10