



More information on the website
radwag.com/us/info,w1,PLS

C315.300.C2.M Load Cell Platform Scale



The drawings, photos and graphics used are for illustrative purposes only.

Functions

 Plus/Minus Control

 Percent Weighing

 Totalizing

 Parts counting

 Internal battery

 Peak hold

 Newton unit measurement

 GLP Procedures

 Animal weighing

 ALIBI Memory

Datasheet

Maximum capacity [Max]	300 kg
Minimum load	2 kg
Readability [d]	100 g
Verification unit [e]	100 g
Tare range	-300 kg
Max readability for non-verified scale	10 g
OIML Class	III

Physical parameters	
Display	LCD (backlit)
Weighing pan dimensions	400×500 mm
Packaging dimensions	720×620×210 mm
Net weight	12,8 kg
Gross weight	14 kg
Construction	
Protection class	IP 65 construction, IP 43 terminal
Construction	mild steel St3S
Weighing pan material	Stainless steel AISI304
Communication interface	RS232
Optional interfaces	RS232
Power supply	100 – 240 V AC 50/60 Hz and battery
Power consumption max.	5 W
Operation time on batteries	max 8h
Operating temperature	-10 – +40 °C
Storage temperature	-10 – +50 °C
Relative humidity	10% – 85% RH no condensation
Indicator	C315



Extra payment for verification



Accessories

Power Adapters

RS 232 cables (scale - printer)

Cigarette lighter receptacle power supply cables

Displays

Displays

RS 232, RS 485 cables

Antivibration tables

RS 232 – Ethernet Converter

AP2-1 Current Loop Unit

RS 232, RS 485 cables

RS 232 – USB Converter

RS 232 cables (scale - printer)

RS 232 – RS 485 Converter

Receipt Printer

Stands, wall mounting kits and mounting brackets

Software

• RAD Key [WX-010-0005]

• Scale Editor - EWAG 2.1 [WX-010-0173]

• R Panel [WX-010-0187]

Device dimensions

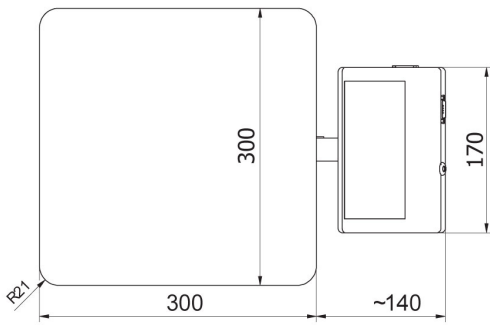

C315.F1.M

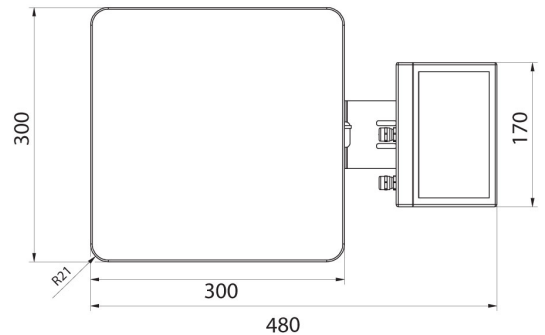
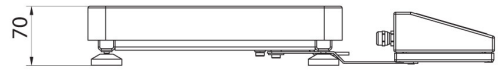

C315.F1.R

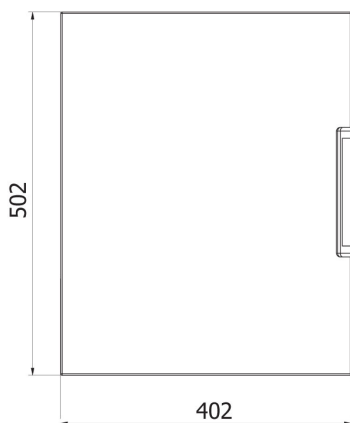

C315.C2.M

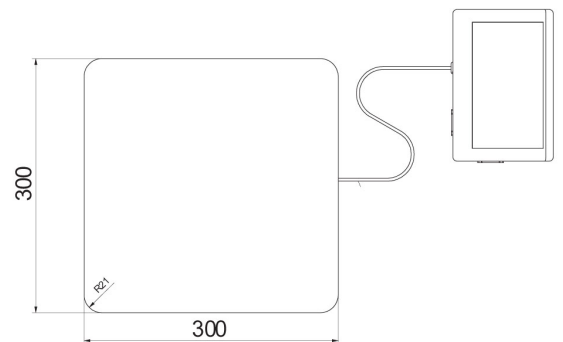
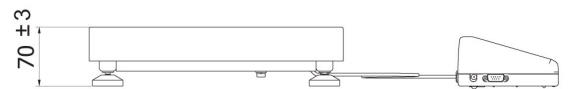

C315.C2.K