



More information on the website  
radwag.com/tr/info,w1,PIQ

# C32.1,5.F1.K Çok Fonksiyonlu Terazi

WP-120-0045



The drawings, photos and graphics used are for illustrative purposes only.

## Fonksiyonlar



Labelling



Plus/Minus Control



Percent Weighing



Totalizing



Parts counting



Newton unit  
measurement



Statistics



IR sensors



GLP Procedures



Replaceable unit



ALIBI Memory

## Teknik Veriler

### Metrolojik parametreler

Maksimum yük [Max]	1,5 kg
Minimum yük [Min]	10 g
Okuma için doğruluğu [d]	0,5 g
Dara aralığı	-1,5 kg
Ticari amaçla kullanılmayan terazi için maksimum hassasiyet	0,2 g
OIML sınıfı	III

Fiziksel parametreler	
Display	5" grafik renkli
Kablo uzunluđu	1 m
Tartım kefesi boyutları	300x300 mm
Ambalaj boyutları	570x390x170 mm
Net ađırlık	5,3 kg
Brüt ađırlık	6,1 kg
Konstrüksiyon	
IP Sınıfı	IP 65 konstrüksiyon, IP 43 terminal
Konstrüksiyon	toz kaplı elik St3S
Tartım kefesi	Paslanmaz elik AISI304
Haberleşme arayüzler	
Haberleşme arayüzü	2xRS232, USB-A, USB-B, Ethernet, 4 IN / 4 OUT (dijital), Wi-Fi
Elektrik parametreleri	
Güç kaynađı	100 – 240 V AC 50/60 Hz
Maksimum güç tüketimi	10 W
Opsiyonel güç kaynađı	dahili batarya
Batarya ile alışma süresi	5 saate kadar sürekli alışma
Çevresel koşullar	
alıştırma sıcaklığı	-10 – +40 °C

\* Ek ücret karşılığında isteđe bađlı donanım

\* Wi-Fi® is a registered trademark of Wi-Fi® Alliance.



Additional fee for verification



## Aksesuarlar (Additional Fee)

Display  
Güç adaptörü  
RS 232 cables (scale - printer)  
akmak prizine uygun besleme kabloları  
Barkod okuyucu  
RS 232, RS 485 cables  
Etiket Yazıcısı  
Display

Display  
Klavye  
Tartım terminalleri için tutucular  
Ek modüller  
Fiş yazıcı  
RS 232, RS 485 Kabloları  
Kablolar RS 232 (Teraziler - Yazıcı)

## Yazılım (Additional Fee)

- E2R Tartım [WX-010-0099]
- RAD Key [WX-010-0005]
- Alibi Okuyucu PC Yazılımı [WX-010-0114]
- Terazi Editörü - EWAG 2.1 [WX-010-0173]

- E2R Tartı Kayıtları [WX-010-0038]
- Etiket Editörü R02 [WX-010-0094]
- R-Lab [WX-010-0080]
- RADWAG Development Studio [WX-010-0104]

# Cihaz boyutları

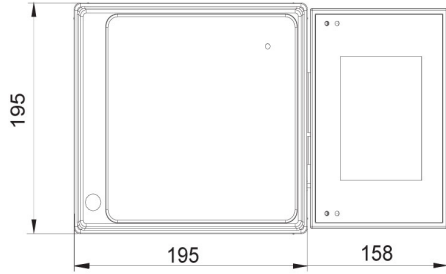
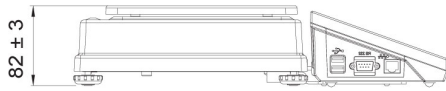

C32.D2

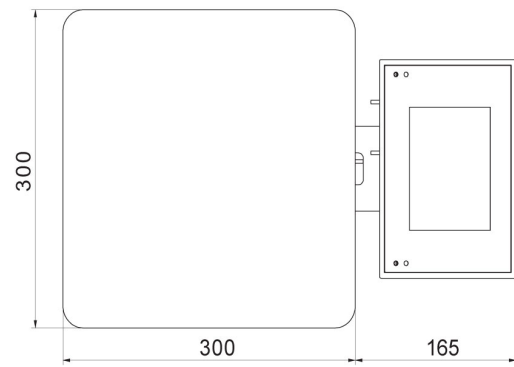
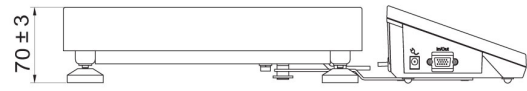

C32.F1.R

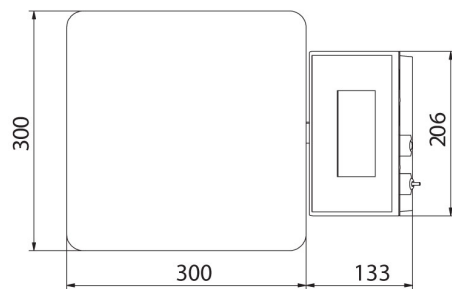
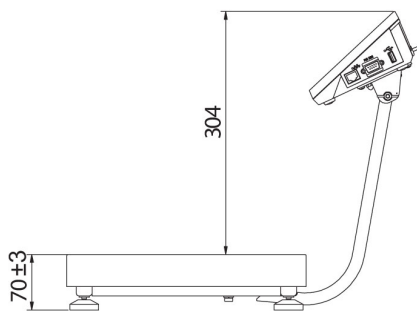

C32.F1.M

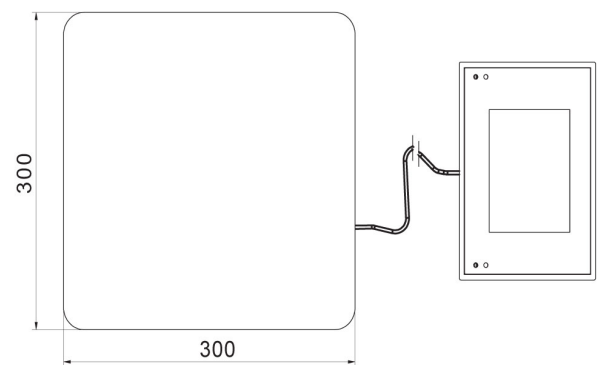
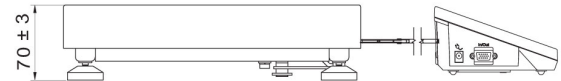

C32.F1.K