



More information on the website
radwag.com/fr/info,w1,OWY

Balance multifonctionnelle C32.3.F1.M



The drawings, photos and graphics used are for illustrative purposes only.

Fonctions



Labelling



Plus/Minus Control



Percent Weighing



Totalizing



Parts counting



Newton unit measurement



Statistics



IR sensors



Under-pan weighing



GLP Procedures



Replaceable unit



ALIBI Memory

Paramètres Techniques

| Paramètres métrologiques | |
|---|-------|
| Capacité maximale [Max] | 3 kg |
| Capacité minimale [Min] | 20 g |
| Précision de lecture | 1 g |
| Étendue de tare | -3 kg |
| Précision de lecture maximale pour les balances non vérifiées | 0,2 g |
| Classe de précision OIML | III |

| Paramètres physiques | |
|---|--|
| Afficheur | 5" graphique couleurs |
| Dimension du plateau | 300×300 mm |
| Dimensions de colis | 570×390×170 mm |
| Masse nette | 5,3 kg |
| Masse brute | 6,6 kg |
| Construction | |
| Degré de protection | IP 65 construction, IP 43 terminal |
| Construction | acier pulvériséacier St3S |
| Matériel du plateau | Acier inoxydable AISI304 |
| Interface de Communication | |
| Interface de Communication | 2×RS232, USB-A, USB-B, Ethernet, 4 IN / 4 OUT (digital), Wi-Fi |
| Paramètres électriques | |
| Alimentation | 100 – 240 V AC 50/60 Hz |
| Prise de courant maximale | 10 W |
| Alimentation optionnelle | accumulateur interne |
| Temps de travail avec l'alimentation d'accumulateur | 5 heures |
| Conditions environnementales | |
| Température du travail | -10 ÷ +40 °C |

* Wi-Fi® is a registered trademark of Wi-Fi® Alliance.



Extra payment for verification



Accessoires

Afficheurs
Alimentateurs
Câbles RS 232 (balance – imprimante)
Câbles d'alimentation de cigare-allume
Lecteurs de code-barres
Câbles RS 232, RS 485
Imprimantes d'étiquettes
Afficheurs

Afficheurs
Claviers, manipulateurs
Supports, Statifs, bras-supports
Modules complémentaires
Imprimante de tickets de caisse
Câbles RS 232, RS 485
Câbles RS 232 (balance – imprimante)

Software

- E2R Pesages [WX-010-0099]
- RAD Key [WX-010-0005]
- Alibi Reader [WX-010-0114]
- Éditeur de Balances 2.1 [WX-010-0173]

- E2R Registre [WX-010-0038]
- Éditeur D'étiquettes R02 [WX-010-0094]
- R-LAB [WX-010-0080]
- RADWAG Studio du Développement [WX-010-0104]

Dimensions d'appareil

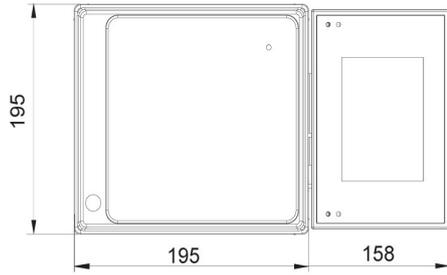
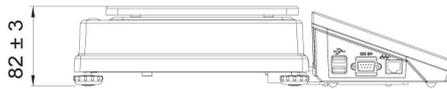

C32.D2

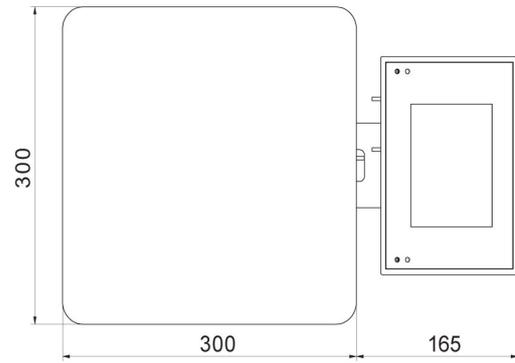
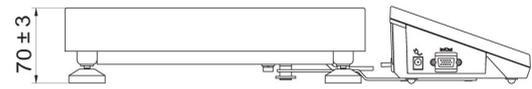

C32.F1.R

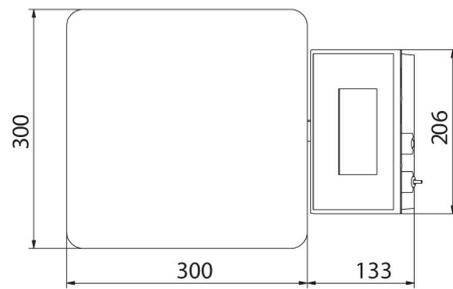
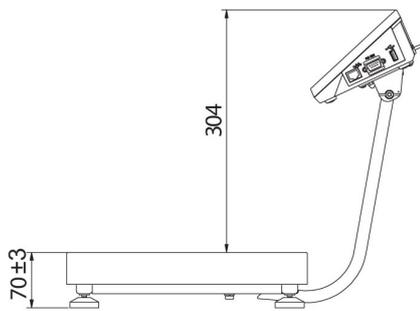

C32.F1.M

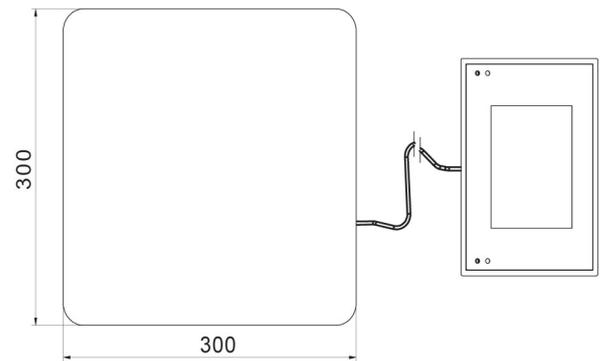
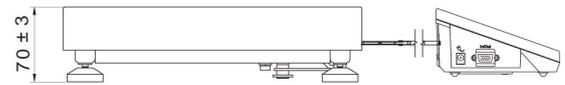

C32.F1.K