



More information on the website
radwag.com/en/info,w1,OUQ

HY10.3.F1.K Multifunctional Scale



The drawings, photos and graphics used are for illustrative purposes only.

Functions

-  Dosing
-  Labelling
-  Plus/Minus Control
-  Percent Weighing
-  Totalizing
-  Parts counting
-  Peak hold
-  Formulation
-  Newton unit measurement
-  Statistics
-  Checkweighing
-  GLP Procedures
-  Animal weighing
-  Differential weighing
-  Replaceable unit
-  Statistical Quality Control
-  ALIBI Memory
-  Transactions

Datasheet

Metrological parameters	
Maximum capacity [Max]	3 kg
Minimum load	20 g
Readability [d]	1 g
Verification unit [e]	1 g

Metrological parameters	
Tare range	-3 kg
Max readability for non-verified scale	0.2 g
Adjustment	external
OIML Class	III
Physical parameters	
Display	10.1" graphic colour touchscreen
Cable length	1 m
Weighing pan dimensions	300×300 mm
Packaging dimensions	390×570×390 mm
Net weight	10.3 kg
Gross weight	12.2 kg
Construction	
Protection class	IP 65 construction, IP 68 (1h max)/69 terminal
Communication interface	
Communication interface	2×RS232, 2×USB-A, Ethernet, 4 IN / 4 OUT (digital)
Optional interfaces	module Wi-Fi 802.11 b/g/n, module Profibus (DP SLAVE), module RS485, module PROFINET (RJ45), analog output module (4-20mA, 0-20mA, 0-10V) , 12IN / 12OUT (IN – 5-24 VDC, OUT – max 30 VDC, 0.5 ADC)
Electrical parameters	
Power supply	100 – 240 V AC 50/60 Hz
Environmental conditions	
Operating temperature	-10 – +40 °C
Relative humidity	10% – 85% RH no condensation

* Wi-Fi® is a registered trademark of Wi-Fi® Alliance.



Extra payment for verification



Accessories

RS 232 cables (scale - printer)
 Transponder card readers
 RS 232 cables (scale - ZEBRA printer)
 RS 232 cables (scale - Ethernet)
 Displays
 RS 232, RS 485 cables
 IN/OUT Cables
 Barcode scanners
 Label Printers

Stands, wall mounting kits and mounting brackets
 Keypad, external switches
 Receipt Printer
 F1 Mass Standard - knob weights without adjustment chamber, set
 USB cable (scale - printer)
 Additional Weighing platforms Module
 Additional modules
 RS 232 – USB Converter

Software

- E2R Weighing [WX-010-0099]
- E2R PGC [WX-010-0051]
- RAD Key [WX-010-0005]

- E2R Formulations [WX-010-0043]
- E2R Weighing Records [WX-010-0038]
- Audit Trail Reader [WX-010-0186]

- Label Editor R02 [WX-010-0094]
- R-Lab [WX-010-0080]
- RADWAG Development Studio [WX-010-0104]

- RADWAG Remote Desktop [WX-010-0107]
- Scale Editor 2.1 [WX-010-0173]

Device dimensions

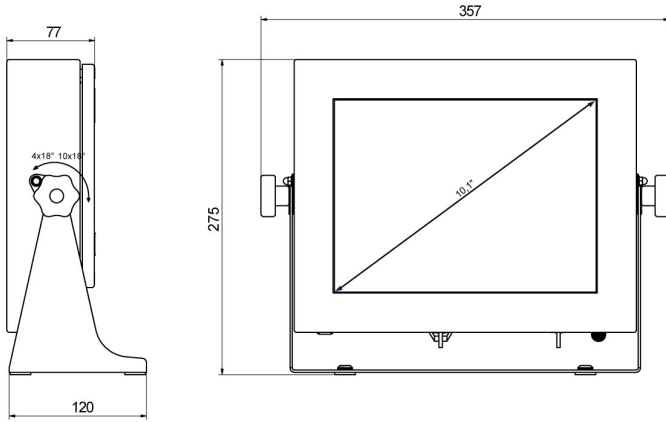
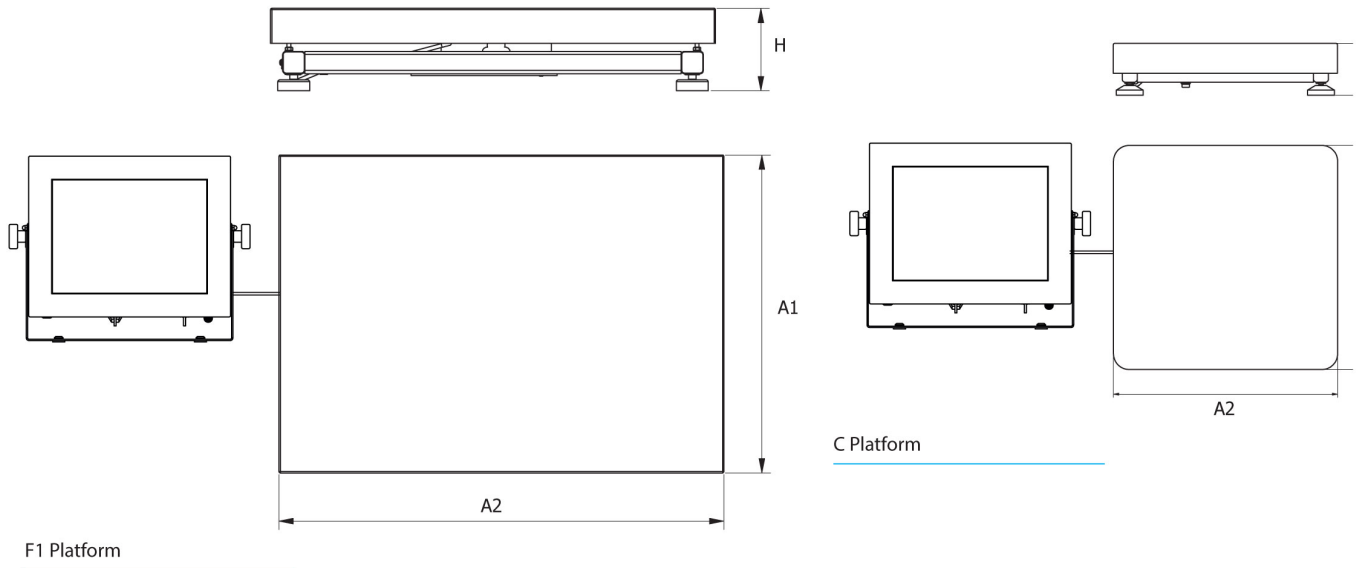

Scale type	A1	A2	H
HY10.C2.K	400	500	103 ±3
HY10.C3.K	500	700	130 ±3
HY10.F1.K	300	300	70 ±3

dimensions in mm

PUE HY10