



More information on the website
radwag.com/it/info,w1,OPA

Bilancia multifunzione C32.3.D2



The drawings, photos and graphics used are for illustrative purposes only.

Funzioni



Labelling



Plus/Minus Control



Percent Weighing



Totalizing



Parts counting



Newton unit measurement



Statistics



IR sensors



GLP Procedures



Replaceable unit



ALIBI Memory

Specifiche

Parametri metrologici	
Portata massima [Max]	3 kg
Portata minima [Min]	20 g
Divisione [d]	1 g
Campo di tara	-3 kg
Massima leggibilità per bilance non verificate	0,1 g
Classe OIML	III

Parametri fisici	
Display	5" graphic colour
Dimensione piatto	195×195 mm
Dimensioni del pacco	530×310×150 mm
Peso netto	3,4 kg
Peso lordo	4 kg
Lunghezza del cavo	1 m
Costruzione	
Punteggio IP	IP 43
Struttura	ABS plastic
Materiale da pesata	Stainless steel AISI304
Interfaccia di comunicazione	
Interfaccia	2×RS232, USB-A, USB-B, Ethernet, 4 IN / 4 OUT (digital), Wi-Fi
Parametri elettrici	
Alimentatore	100 – 240 V AC 50/60 Hz
Massimo assorbimento elettrico	10 W
Alimentatore opzionale	internal rechargeable battery
Tempo operativo delle batterie	operation time up to 5 h
Environmental conditions	
Ambiente di lavoro	-10 ÷ +40 °C

* Wi-Fi® is a registered trademark of Wi-Fi® Alliance.



Extra payment for verification



Accessori

Display
 Alimentatore
 Cavo seriale RS 232 (connessione bilance - Stampanti)
 Cavo di alimentazione con spina per accendisigari
 Lettore di codici a barre
 Cavo seriale RS 232, RS 485
 stampanti per etichette
 Display

Display
 Tastiera, interruttori esterni
 Supporto, set di montaggio a muro e braccetti di montaggio
 Moduli aggiuntivi
 Stampanti di ricevuata
 Cavo seriale RS 232, RS 485
 Cavo seriale RS 232 (connessione bilance - Stampanti)

Software

- E2R Weighing [WX-010-0099]
- RAD Key [WX-010-0005]
- „Alibi Reader” PC Software [WX-010-0114]
- Editore per sistemi di pesatura 2.1 [WX-010-0173]

- E2R Weighing Records [WX-010-0038]
- Editore di etichette R02 [WX-010-0094]
- R-LAB [WX-010-0080]
- Software „Development Studio” RADWAG [WX-010-0104]

Device dimensions



C32.D2



C32.F1.R

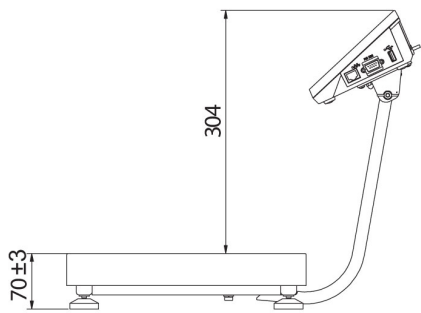

C32.F1.M



C32.F1.K