



More information on the website
radwag.com/fr/info,w1,OPA

Balance multifonctionnelle C32.3.D2



The drawings, photos and graphics used are for illustrative purposes only.

Fonctions



Labelling



Plus/Minus Control



Percent Weighing



Totalizing



Parts counting



Newton unit measurement



Statistics



IR sensors



GLP Procedures



Replaceable unit



ALIBI Memory

Paramètres Techniques

Paramètres métrologiques

Capacité maximale [Max]	3 kg
Capacité minimale [Min]	20 g
Précision de lecture	1 g
Étendue de tare	-3 kg
Précision de lecture maximale pour les balances non vérifiées	0,1 g
Classe de précision OIML	III

Paramètres physiques	
Afficheur	5" graphique couleurs
Longueur de câble	1 m
Dimension du plateau	195×195 mm
Dimensions de colis	530×310×150 mm
Masse nette	3,4 kg
Masse brute	4 kg
Construction	
Degré de protection	IP 43
Boîtier	matière ABS
Matériel du plateau	Acier inoxydable AISI304
Interface de Communication	
Interface de Communication	2×RS232, USB-A, USB-B, Ethernet, 4 IN / 4 OUT (numériques), Wi-Fi
Paramètres électriques	
Alimentation	100 – 240 V AC 50/60 Hz
Prise de courant maximale	10 W
Alimentation optionnelle	accumulateur interne
Temps de travail avec l'alimentation d'accumulateur	5 heures
Conditions environnementales	
Température du travail	-10 – +40 °C

* Equipement en option avec supplément de prix

* Wi-Fi® is a registered trademark of Wi-Fi® Alliance.



Extra payment for verification



Accessoires

Afficheurs
Alimentateurs
Câbles RS 232 (balance – imprimante)
Câbles d'alimentation de cigare-allume
Lecteurs de code-barres
Câbles RS 232, RS 485
Imprimantes d'étiquettes
Afficheurs

Afficheurs
Claviers, manipulateurs
Supports, Statifs, bras-supports
Modules complémentaires
Imprimante de tickets de caisse
Câbles RS 232, RS 485
Câbles RS 232 (balance – imprimante)

Software

- E2R Pesages [WX-010-0099]
- RAD Key [WX-010-0005]
- Alibi Reader [WX-010-0114]
- Éditeur de Balances 2.1 [WX-010-0173]

- E2R Registre [WX-010-0038]
- Éditeur D'étiquettes R02 [WX-010-0094]
- R-LAB [WX-010-0080]
- RADWAG Studio du Développement [WX-010-0104]

Dimensions d'appareil

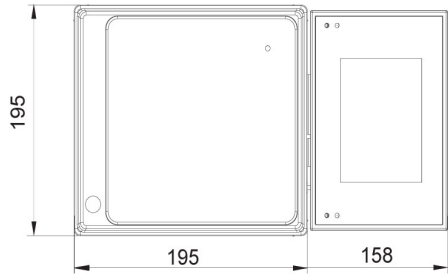
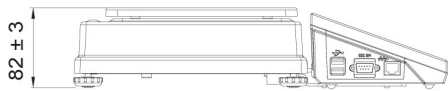

C32.D2

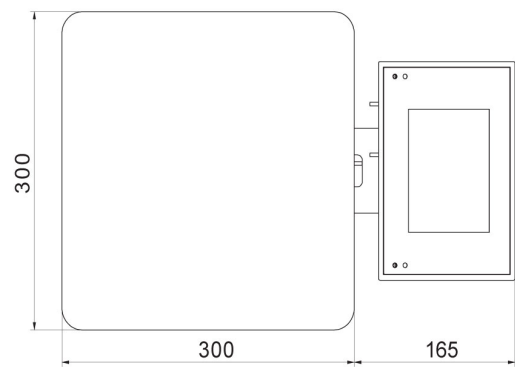
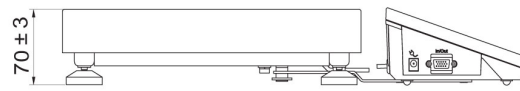

C32.F1.R

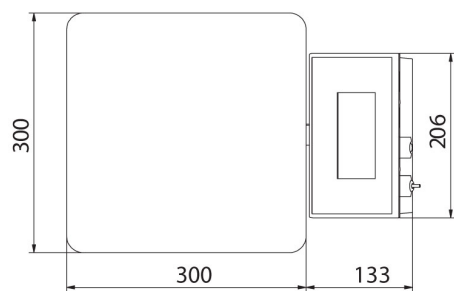
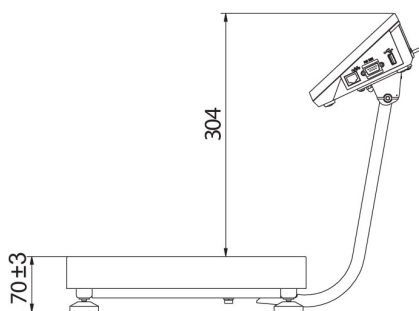

C32.F1.M

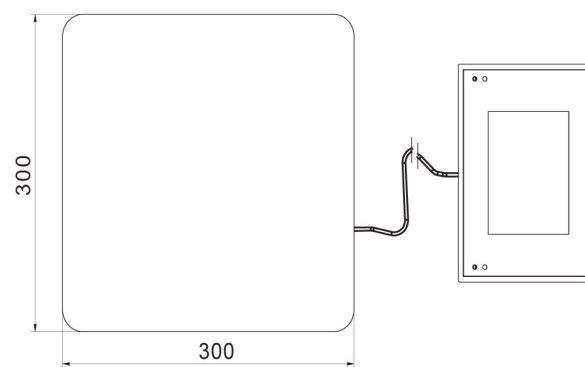
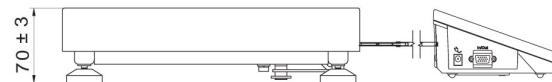

C32.F1.K