





















More information on the website  
radwag.com/fr/info,w1,0AN

# Balance à haute résolution HY10.2000.HRP.H.M2.1



The drawings, photos and graphics used are for illustrative purposes only.

## Fonctions

-  Dosing
-  Labelling
-  Plus/Minus Control
-  Percent Weighing
-  Totalizing
-  Parts counting
-  Peak hold
-  Formulation
-  Newton unit measurement
-  Statistics
-  Checkweighing
-  GLP Procedures
-  Animal weighing
-  Differential weighing
-  Replaceable unit
-  Statistical Quality Control
-  ALIBI Memory
-  Transactions

## Paramètres Techniques

### Paramètres métrologiques

Capacité maximale [Max]	2000 kg
Capacité minimale [Min]	500 g
Capacité préliminaire	200 kg
Précision de lecture	10 g

Paramètres métrologiques	
Échelon de légalisation [e]	100 g
Étendue de tare	-2000 kg
Répétabilité	30 g
Linéarité	±60 g
Temps de stabilisation	3 s
Ajustage	interne (automatique)
Classe de précision OIML	II
Nombre maximal d'échelons de légalisation	20000 e
Paramètres physiques	
Afficheur	10" graphique couleurs écran tactile
Dimension du plateau	1250×1000 mm
Construction	
Degré de protection	IP 66/67 construction, IP 68/69 terminal
Construction	Acier inoxydable AISI304
Matériel du plateau	Acier inoxydable AISI304
Interface de Communication	
Interface de Communication	2×RS232, 2×USB-A, Ethernet, 4 IN / 4 OUT (numériques)
Interfaces optionnelles	module Wi-Fi 802.11 b/g/n, module Profibus (DP SLAVE), module RS485, module PROFINET (RJ45), module de sorties analogiques (4-20mA, 0-20mA, 0-10V) , 12IN / 12OUT (IN – 5-24 VDC, OUT – max 30 VDC, 0,5 ADC)
Paramètres électriques	
Alimentation	100 – 240 V AC 50/60 Hz
Conditions environnementales	
Température du travail	+10 ÷ +40 °C
Humidité relative d'air	40% ÷ 80%

**La répétabilité** est exprimée en écart-type de dix positions de charge.  
**Humidité relative de l'air** dans des conditions sans condensation.  
**Temps de stabilisation** dans des conditions ambiantes optimales.

\* Wi-Fi® is a registered trademark of Wi-Fi® Alliance.



Extra payment for verification



## Accessoires

Câbles RS 232 (balance – imprimante)  
Lecteurs de cartes à transpondeur  
Câbles RS 232 (balance – imprimante ZEBRA)  
Câbles de réseau (balance – Ethernet)

Imprimantes d'étiquettes  
Supports, Statifs, bras-supports  
Claviers, manipulateurs  
Imprimante de tickets de caisse

Afficheurs  
 Câbles RS 232, RS 485  
 Câbles d'Entrées/ de Sorties  
 Lecteurs de code-barres

Câble USB (balance – imprimante)  
 Modules de plateforme supplémentaires  
 Modules complémentaires  
 Convertisseur RS 232 – USB

## Software

- E2R Pesages [WX-010-0099]
- E2R Registre [WX-010-0038]
- Audit Trail Reader [WX-010-0186]
- RADWAG Remote Desktop [WX-010-0107]
- Éditeur de Balances 2.1 [WX-010-0173]
- E2R Recettes [WX-010-0043]
- RAD Key [WX-010-0005]
- Éditeur D'étiquettes R02 [WX-010-0094]
- R-LAB [WX-010-0080]
- RADWAG Studio du Développement [WX-010-0104]

## Dimensions d'appareil

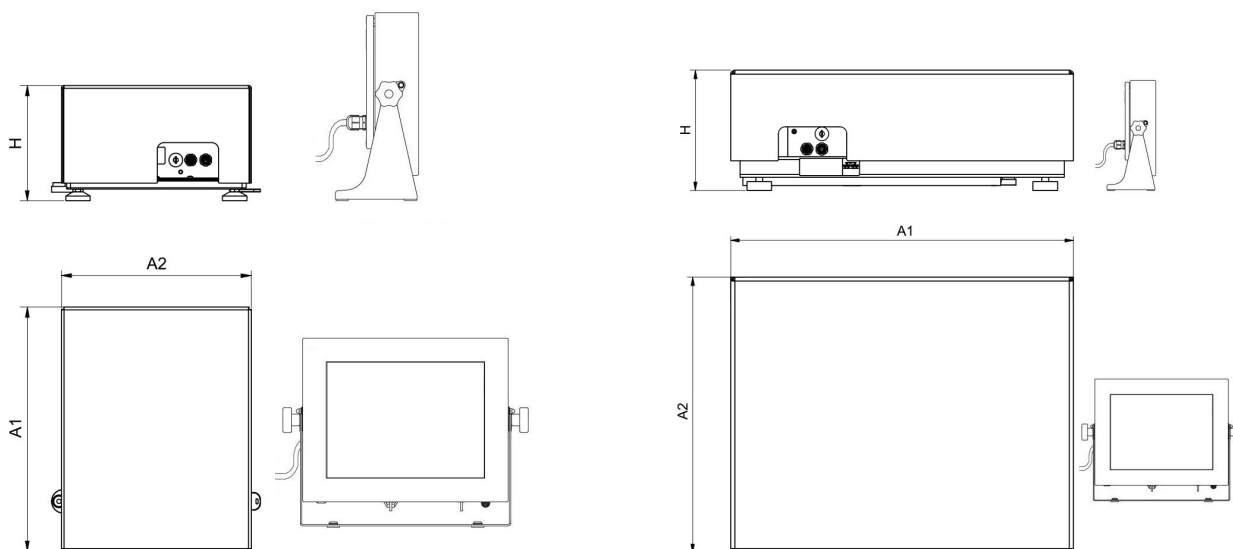

HY10.16 - 32.HRP.H

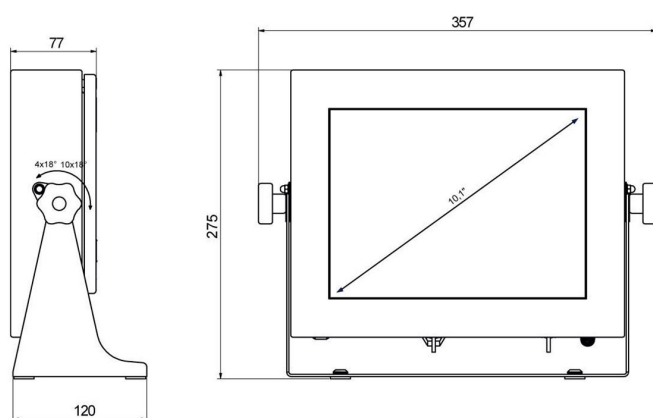

PUE HY10

Scale type	A1	A2	H
HY10.(16-32).HRP.H	360	280	180±5
HY10.(62-150).HRP.H	500	400	180±5
HY10.150.2.HRP.H	500	500	180±5
HY10.(150.1-300).HRP.H	800	600	180±5
HY10.(300.1-1100).HRP.H	1000	800	180±5
HY10.(2000).HRP.H	1250	1000	180±5

Dimensions in mm