

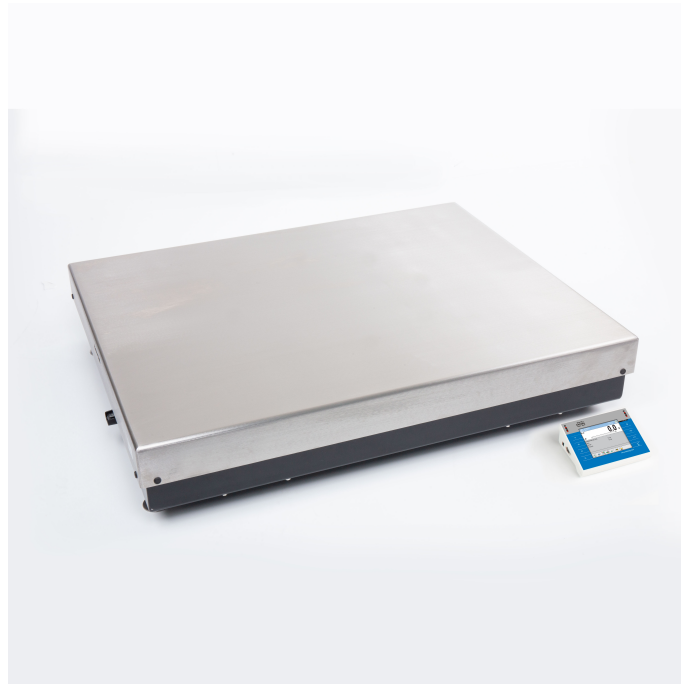

More information on the website
radwag.com/it/info,w1,00K

Basamento ad alta risoluzione PUE 7.1.600.HRP.M2.1



The drawings, photos and graphics used are for illustrative purposes only.

Foglio di calcolo

Parametri metrologici	
Capacità massima [Max]	600 kg
Pesata minima	500 g
Intervallo di precarico	60 kg
Accuratezza	10 g
Intervallo di verifica della bilancia [e]	100 g
Intervallo di tara	-600 kg
Ripetibilità	7,5 g
Linearità	±15 g
Tempo di stabilizzazione	3 s
Calibrazione	internal (automatic)
Classe OIML	II
Quantità massima di unità verificate	6000 e
Parametri fisici	
Display	5,7" Resistiv-Farb-Touchscreen
Dimensioni del piatto di pesata	1000×800 mm

Parametri fisici	
Device dimensions	360×313×170 mm
Dimensioni del pacco	1000×1200×436 mm
Peso netto	126 kg
Peso lordo	160 kg
Costruzione	
Punteggio IP	IP 66/67 construction, IP 43 indicator
Costruzione	mild steel St3S
Materiale da pesata	Stainless steel AISI304
Interfaccia di comunicazione	
Interfaccia	2×RS232, 2×USB-A, Ethernet, 4 IN / 4 OUT (digital), Wi-Fi
Parametri elettrici	
Alimentatore	100 – 240 V AC 50/60 Hz
Environmental conditions	
Temperatura di lavoro	+10 ÷ +40 °C
Umidità atmosferica	40% ÷ 80%

* Wi-Fi® is a registered trademark of Wi-Fi® Alliance.



Extra payment for verification



Accessori

Display

Lettore di tessere transponder

Cavo seriale RS 232 (connessione bilance - Ethernet)

Cavo seriale RS 232 (connessione bilance - Stampanti)

Lettore di codici a barre

stampanti per etichette

Stampanti di ricevuata

Moduli aggiuntivi della piattaforma

RS 232 – USB Converter

Software

• E2R Weighing [WX-010-0099]

• RAD Key [WX-010-0005]

• RADWAG Remote Desktop [WX-010-0107]

• Editore per sistemi di pesatura 2.1 [WX-010-0173]

• E2R Weighing Records [WX-010-0038]

• Editore di etichette R02 [WX-010-0094]

• R-LAB [WX-010-0080]

• Software „Development Studio“ RADWAG [WX-010-0104]

Device dimensions

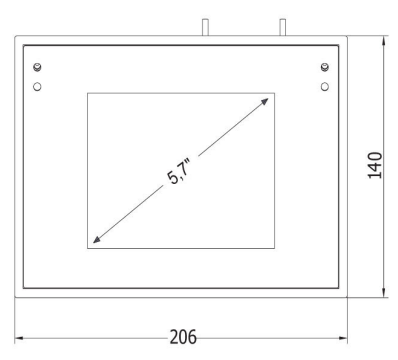
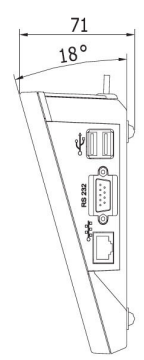
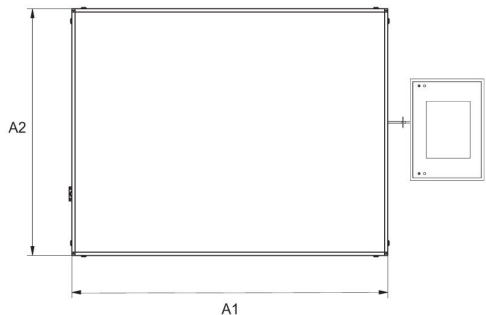
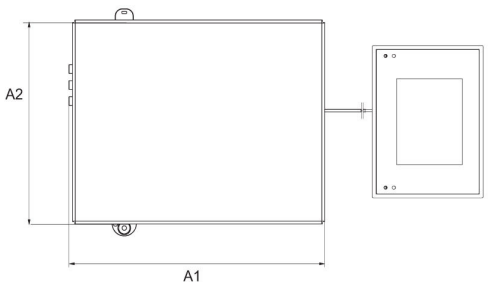
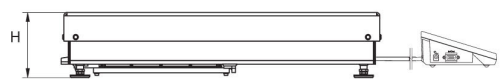
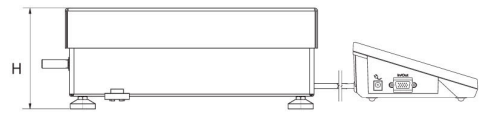

Scale type	A1	A2	H
PUE7.1.16 - 32.HRP	360	280	139±3
PUE7.1.62 - 120.HRP	500	500	175±3
PUE7.1.150 - 300.HRP	800	600	175±3
PUE7.1.300.1 - 1100.HRP	1000	800	175±3
PUE7.1.2000.HRP	1250	1000	175±3

dimensions in mm