



More information on the website
radwag.com/it/info,w1,M20

Bilancia multifunzione C32.30.F1.R



The drawings, photos and graphics used are for illustrative purposes only.

Funzioni



Labelling



Plus/Minus Control



Percent Weighing



Totalizing



Parts counting



Newton unit measurement



Statistics



IR sensors



GLP Procedures



Replaceable unit



ALIBI Memory

Specifiche

Parametri metrologici	
Portata massima [Max]	30 kg
Portata minima [Min]	200 g
Divisione [d]	10 g
Campo di tara	-30 kg
Massima leggibilità per bilance non verificate	1 g
Classe OIML	III

Parametri fisici	
Sistema di livellamento	manual
Display	5" graphic colour
Dimensione piatto	300×300 mm
Dimensioni del pacco	570×390×170 mm
Peso netto	5,3 kg
Peso lordo	6,1 kg
Costruzione	
Punteggio IP	IP 65 construction, IP 43 terminal
Costruzione	mild steel St3S
Materiale da pesata	Stainless steel AISI304
Interfaccia di comunicazione	
Interfaccia	2×RS232, USB-A, USB-B, Ethernet, 4 IN / 4 OUT (digital), Wi-Fi
Parametri elettrici	
Alimentatore	100 – 240 V AC 50/60 Hz
Massimo assorbimento elettrico	10 W
Alimentatore opzionale	internal rechargeable battery
Tempo operativo delle batterie	operation time up to 5 h
Environmental conditions	
Ambiente di lavoro	-10 – +40 °C

* Equipaggiamento opzionale a pagamento

* Wi-Fi® is a registered trademark of Wi-Fi® Alliance.



Extra payment for verification



Accessori

Display
 Alimentatore
 Cavo seriale RS 232 (connessione bilance - Stampanti)
 Cavo di alimentazione con spina per accendisigari
 Lettore di codici a barre
 Cavo seriale RS 232, RS 485
 stampanti per etichette
 Display

Display
 Tastiera, interruttori esterni
 Supporto, set di montaggio a muro e braccetti di montaggio
 Moduli aggiuntivi
 Stampanti di ricevuta
 Cavo seriale RS 232, RS 485
 Cavo seriale RS 232 (connessione bilance - Stampanti)

Software

- E2R Weighing [WX-010-0099]
- RAD Key [WX-010-0005]
- „Alibi Reader” PC Software [WX-010-0114]
- Editore per sistemi di pesatura 2.1 [WX-010-0173]

- E2R Weighing Records [WX-010-0038]
- Editore di etichette R02 [WX-010-0094]
- R-LAB [WX-010-0080]
- Software „Development Studio” RADWAG [WX-010-0104]

Device dimensions

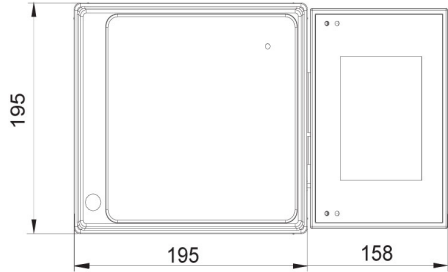

C32.D2

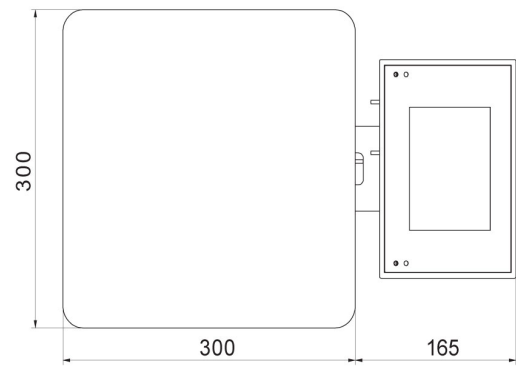
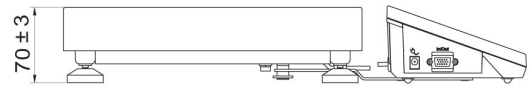

C32.F1.R

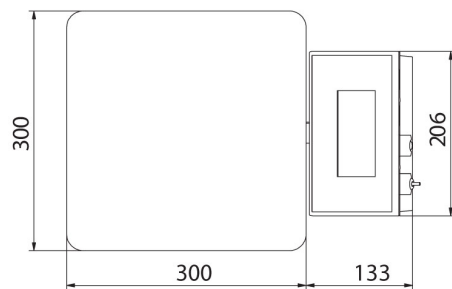

C32.F1.M

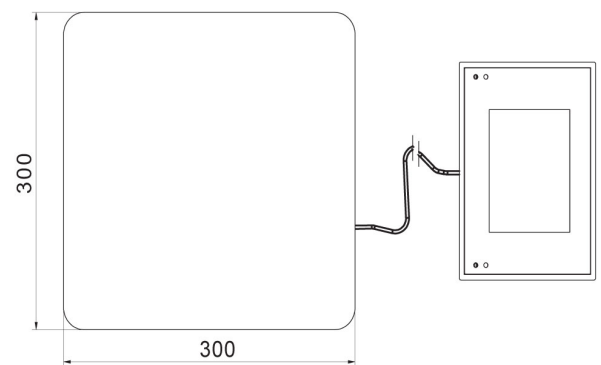
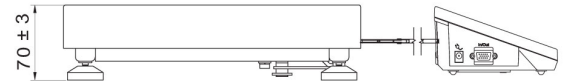

C32.F1.K