

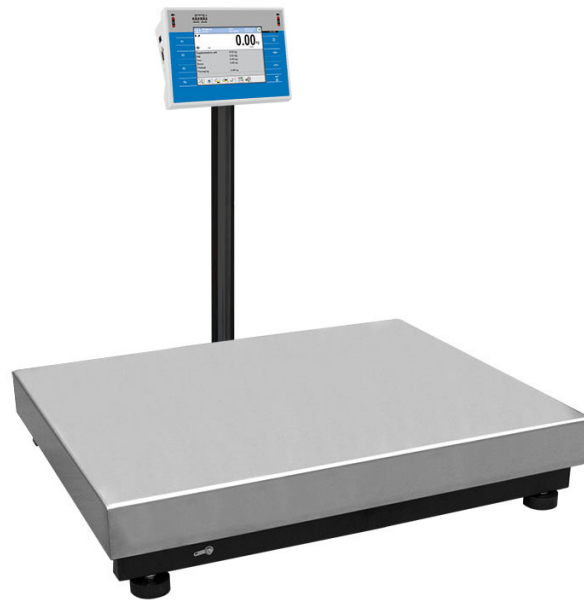

More information on the website  
[radwag.com/de/info,w1,LTK](http://radwag.com/de/info,w1,LTK)

# Multifunktionswaage WPY 300/C2



The drawings, photos and graphics used are for illustrative purposes only.

## Funktionen

-  Dosing
-  Labelling
-  Plus/Minus Control
-  Percent Weighing
-  Totalizing
-  Parts counting
-  Peak hold
-  Formulation
-  Newton unit measurement
-  Statistics
-  Checkweighing
-  IR sensors
-  Animal weighing
-  Differential weighing
-  ALIBI Memory

## Technische Daten

Messtechnische Parameter	
Wägebereich [Max]	300 kg
Min. Belastung	2 kg
Zifferschritt [d]	100 g
Tarierbereich	-300 kg
Max Ablesbarkeit [d] bei nicht geeichter Waage	10 g
Stabilisierungszeit	3 s

Messtechnische Parameter	
Justierung	extern
OIML-Klasse	III
Physikalische Parameter	
Display	5,7" Resistiv-Farb-Touchscreen
Waagschale	400×500 mm
Verpackungsgröße	720×620×210 mm
Nettogewicht	11,1 kg
Bruttogewicht	13,1 kg
Konstruktion	
Schutzart	IP 43
Kommunikationsschnittstellen	
Schnittstellen	2×RS232, 2×USB-A, Ethernet, 4 IN / 4 OUT (Digitalausgang), Wi-Fi
Elektrische Parameter	
Stromversorgung	100 – 240 V AC 50/60 Hz
Umgebungsbedingungen	
Umgebungstemperatur	-10 – +40 °C

**Die Stabilisierungszeit** ist abhängig von den Umgebungsbedingungen und der Geschwindigkeit bei Auflegen der Last auf der Waagschale; für FAST-Profil definiert.

\* Wi-Fi® is a registered trademark of Wi-Fi® Alliance.



Extra payment for verification



## Zubehör

Transponderkartenleser  
Kabel RS 232 (Waage – Drucker)  
Anschlusskabel für Zigarettenanzünder  
Barcode-Scanner  
Kabel RS 232, RS 485  
Etikettendrucker  
Antivibrationstische  
Displays  
E/A Kabel

Tastaturen, Taster  
Wandhalterung, Stativ  
Thermische Drucker  
Prüfgewichte der F1 Klasse - Knopfgewichte, Sätze  
Ausgang der Stromschnittstelle AP2-1  
Kabel RS 232, RS 485  
Modul für zusätzliche Wägeplattformen  
Konverter RS 232 – USB  
Kabel RS 232 (Waage – Drucker)

## Software

- E2R Wägung [WX-010-0099]
- E2R FPVO [WX-010-0051]
- RAD Key [WX-010-0005]
- Etiketten-Editor R02 [WX-010-0094]
- RLAB [WX-010-0080]
- RADWAG Development Studio [WX-010-0104]

- E2R Rezepturen [WX-010-0043]
- E2R Evidenz [WX-010-0038]
- Audit Trail Reader [WX-010-0186]
- Radwag Remote Desktop [WX-010-0107]
- Scale Editor 2.1 [WX-010-0173]

## Abmessungen des Geräts

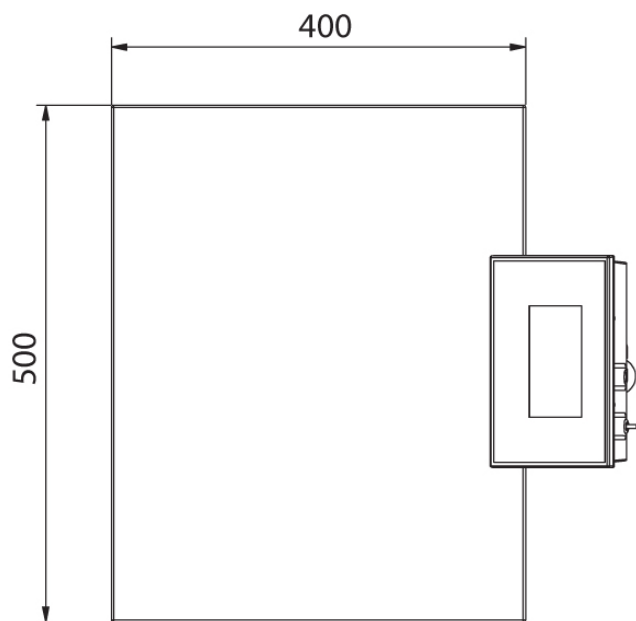

WPY C2/M