



More information on the website  
radwag.com/it/info,w1,KRW

# Bilancia multifunzione HY10.15.C2.K



The drawings, photos and graphics used are for illustrative purposes only.

## Funzioni

-  Dosing
-  Labelling
-  Plus/Minus Control
-  Percent Weighing
-  Totalizing
-  Parts counting
-  Peak hold
-  Formulation
-  Newton unit measurement
-  Statistics
-  Checkweighing
-  GLP Procedures
-  Animal weighing
-  Differential weighing
-  Replaceable unit
-  Statistical Quality Control
-  ALIBI Memory
-  Transactions

## Specifiche

Parametri metrologici	
Portata massima [Max]	15 kg
Portata minima [Min]	100 g
Divisione [d]	5 g
Intervallo di verifica della bilancia [e]	5 g

Parametri metrologici	
Campo di tara	-15 kg
Massima leggibilità per bilance non verificate	0,5 g
Calibrazione	external
Classe OIML	III
Parametri fisici	
Display	10,1" graphic colour touchscreen
Lunghezza del cavo	2,5 m
Dimensione piatto	400x500 mm
Dimensioni del pacco	620x720x440 mm
Peso netto	16 kg
Peso lordo	18 kg
Costruzione	
Punteggio IP	IP 65 construction, IP 68 (1h max)/69 terminal
Interfaccia di comunicazione	
Interfaccia	2xRS232, 2xUSB-A, Ethernet, 4 IN / 4 OUT (digital)
Interfacce opzionali	module Wi-Fi 802.11 b/g/n, module Profibus (DP SLAVE), module RS485, module PROFINET (RJ45), analog output module (4-20mA, 0-20mA, 0-10V) , 12IN / 12OUT (IN – 5-24 VDC, OUT – max 30 VDC, 0,5 ADC)
Parametri elettrici	
Alimentatore	100 – 240 V AC 50/60 Hz
Environmental conditions	
Ambiente di lavoro	-10 – +40 °C
Umidità relativa	10% – 85% RH no condensation

\* Wi-Fi® is a registered trademark of Wi-Fi® Alliance.



Extra payment for verification



## Accessori

Cavo seriale RS 232 (connessione bilance - Stampanti)  
 Lettore di tessere transponder  
 Cavo seriale RS 232 (connessione bilance - Stampanti ZEBRA)  
 Cavo seriale RS 232 (connessione bilance - Ethernet)  
 Display  
 Cavo seriale RS 232, RS 485  
 cavi IN/OUT  
 Lettore di codici a barre  
 stampanti per etichette

Supporto, set di montaggio a muro e braccetti di montaggio  
 Tastiera, interruttori esterni  
 Stampanti di ricevuata  
 Pesi standard F1 - cilindrici, set  
 cavo USB (connessione bilance - stampanti)  
 Moduli aggiuntivi della piattaforma  
 Moduli aggiuntivi  
 RS 232 – USB Converter

## Software

- E2R Weighing [WX-010-0099]
- E2R PGC [WX-010-0051]
- RAD Key [WX-010-0005]

- E2R Formulazione [WX-010-0043]
- E2R Weighing Records [WX-010-0038]
- Audit Trail Reader [WX-010-0186]

- Editore di etichette R02 [WX-010-0094]
- R-LAB [WX-010-0080]
- Software „Development Studio” RADWAG [WX-010-0104]

- RADWAG Remote Desktop [WX-010-0107]
- Editore per sistemi di pesatura 2.1 [WX-010-0173]

## Device dimensions

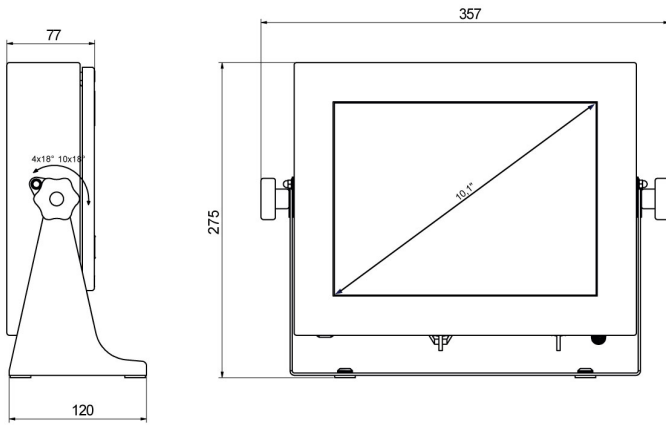
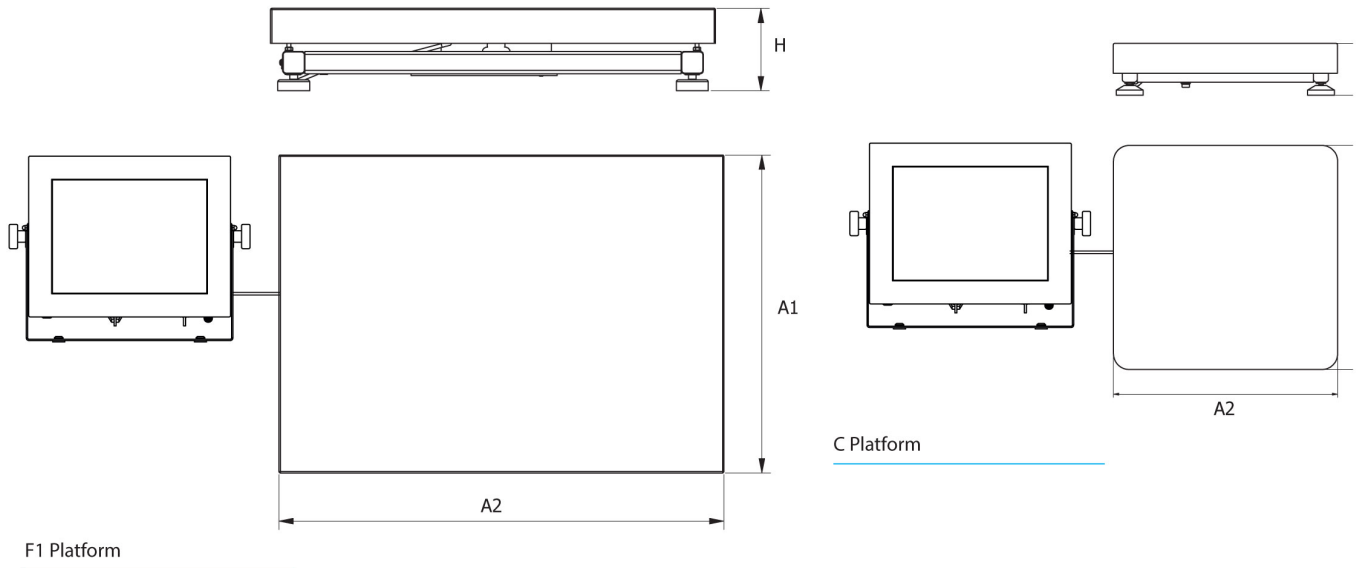

PUE HY10

Scale type	A1	A2	H
HY10.C2.K	400	500	103 ±3
HY10.C3.K	500	700	130 ±3
HY10.F1.K	300	300	70 ±3

dimensions in mm