



More information on the website
radwag.com/en/info,w1,KRW

HY10.15.C2.K Multifunctional Scale



The drawings, photos and graphics used are for illustrative purposes only.

Functions

-  Dosing
-  Labelling
-  Plus/Minus Control
-  Percent Weighing
-  Totalizing
-  Parts counting
-  Peak hold
-  Formulation
-  Newton unit measurement
-  Statistics
-  Checkweighing
-  GLP Procedures
-  Animal weighing
-  Differential weighing
-  Replaceable unit
-  Statistical Quality Control
-  ALIBI Memory
-  Transactions

Datasheet

| Metrological parameters | |
|-------------------------|-------|
| Maximum capacity [Max] | 15 kg |
| Minimum load | 100 g |
| Readability [d] | 5 g |
| Verification unit [e] | 5 g |

| Metrological parameters | |
|--|---|
| Tare range | -15 kg |
| Max readability for non-verified scale | 0.5 g |
| Adjustment | external |
| OIML Class | III |
| Physical parameters | |
| Display | 10" graphic colour touchscreen |
| Weighing pan dimensions | 400×500 mm |
| Packaging dimensions | 620×720×440 mm |
| Net weight | 16 kg |
| Gross weight | 18 kg |
| Cable length | 2.5 m |
| Construction | |
| Protection class | IP 65 construction, IP 68 (1h max)/69 terminal |
| Communication interface | |
| Communication interface | 2×RS232, 2×USB-A, Ethernet, 4 IN / 4 OUT (digital) |
| Optional interfaces | module Wi-Fi 802.11 b/g/n, module Profibus (DP SLAVE), module RS485, module PROFINET (RJ45), analog output module (4-20mA, 0-20mA, 0-10V) , 12IN / 12OUT (IN – 5-24 VDC, OUT – max 30 VDC, 0.5 ADC) |
| Electrical parameters | |
| Power supply | 100 – 240 V AC 50/60 Hz |
| Environmental conditions | |
| Operating temperature | -10 ÷ +40 °C |
| Relative humidity | 10% ÷ 85% RH no condensation |

* Wi-Fi® is a registered trademark of Wi-Fi® Alliance.



Extra payment for verification



Accessories

RS 232 cables (scale - printer)
 Transponder card readers
 RS 232 cables (scale - ZEBRA printer)
 RS 232 cables (scale - Ethernet)
 Displays
 RS 232, RS 485 cables
 IN/OUT Cables
 Barcode scanners
 Label Printers

Stands, wall mounting kits and mounting brackets
 Keypad, external switches
 Receipt Printer
 F1 Mass Standard - knob weights without adjustment chamber, set
 USB cable (scale - printer)
 Additional Weighing platforms Module
 Additional modules
 RS 232 – USB Converter

Software

- E2R Weighing [WX-010-0099]
- E2R PGC [WX-010-0051]
- RAD Key [WX-010-0005]

- E2R Formulations [WX-010-0043]
- E2R Weighing Records [WX-010-0038]
- Audit Trail Reader [WX-010-0186]

- Label Editor R02 [WX-010-0094]
- R-Lab [WX-010-0080]
- RADWAG Development Studio [WX-010-0104]

- RADWAG Remote Desktop [WX-010-0107]
- Scale Editor 2.1 [WX-010-0173]

Device dimensions

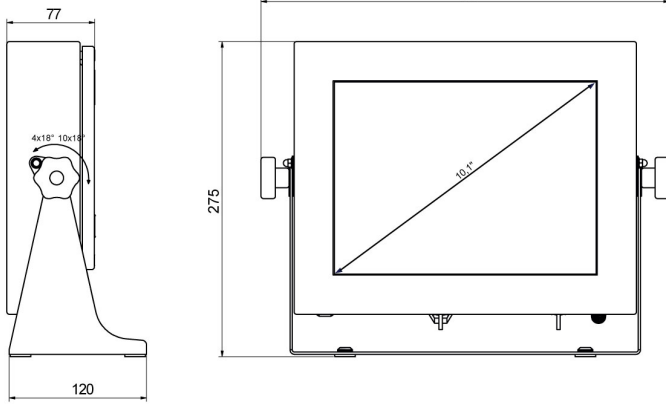
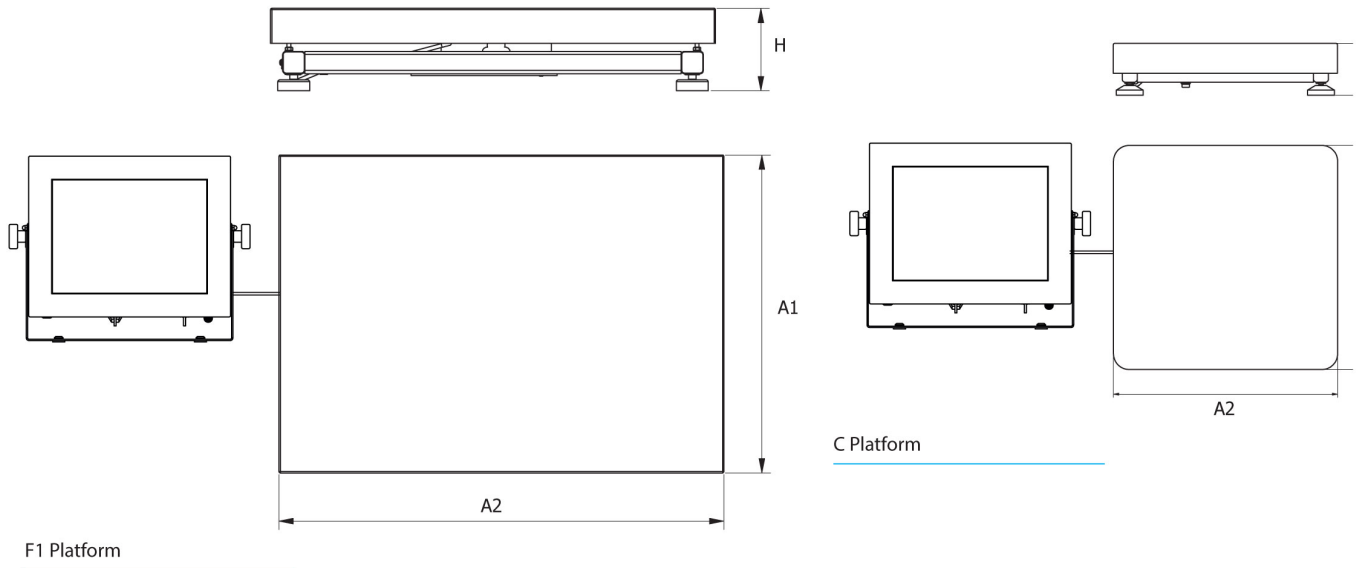

| Scale type | A1 | A2 | H |
|------------|-----|-----|--------|
| HY10.C2.K | 400 | 500 | 103 ±3 |
| HY10.C3.K | 500 | 700 | 130 ±3 |
| HY10.F1.K | 300 | 300 | 70 ±3 |

dimensions in mm

PUE HY10