



More information on the website
radwag.com/en/info,w1,KET

KR-04-2 Converter



The drawings, photos and graphics used are for illustrative purposes only.

Overview

KR-04-2 converter is designed for scales not equipped with the Ethernet interface. The device enables operation of a scale equipped only with RS 232 in weighing systems based on LAN network. It is intended for PUE C31/H.

The converter features a stainless steel housing, RS 232 cable with a hermetic plug, Ethernet cable fed through a cable gland and terminated with RJ45 plug.

The latest version of Network Enabler Administrator software: 2.11

Compatible with

H315 HR Waterproof Platform Scale
 H315 4H Stainless Steel Platform Scale
 H315 4P2.H Stainless steel Beam Scales
 H315 H Waterproof Platform Scale
 H315.4 H/Z Stainless Steel Platform Scale, pit version
 H315 4N.H Stainless Steel Ramp Scale

H315 4N.H.LD Stainless Steel Ramp Scale
 H315 2K Overhead Track Scales
 H315 4P.H Stainless Steel Pallet Scales
 H315 4I.S Livestock Scales
 H315 4I.H Stainless Steel Livestock Scales
 H315 Stainless Steel Overhead Track Scales

Device dimensions

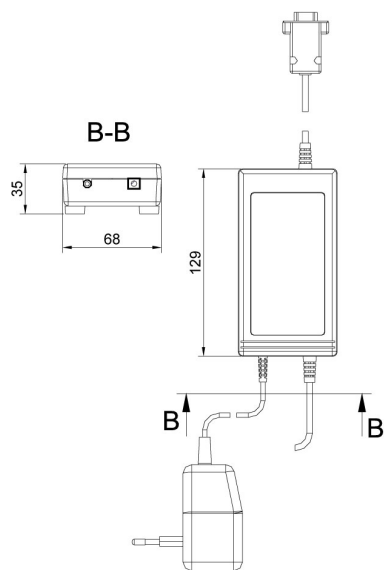

KR-01, KR-04 converter

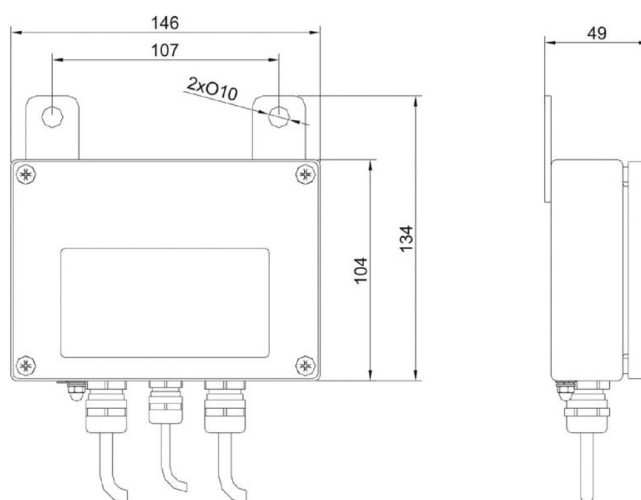

KR-04-2, KR-04-3 converter