

















More information on the website  
[radwag.com/us/info,w1,JYE](http://radwag.com/us/info,w1,JYE)

# WLY 30/F1/R Precision Balance



The drawings, photos and graphics used are for illustrative purposes only.

## Functions

-  Dosing
-  Labelling
-  Plus/Minus Control
-  Percent Weighing
-  Totalizing
-  Parts counting
-  Peak hold
-  Formulation
-  Newton unit measurement
-  Statistics
-  Checkweighing
-  IR sensors
-  Animal weighing
-  Differential weighing
-  ALIBI Memory

## Datasheet

Maximum capacity [Max]	30 kg
Minimum load	-
Readability [d]	0,5 g
Verification unit [e]	-
Tare range	-30 kg
Repeatability	1 g

Linearity	±1 g
Stabilization time	3 s
Adjustment	external
OIML Class	-
<b>Physical parameters</b>	
Leveling system	manualny
Weighing pan dimensions	300×300 mm
Packaging dimensions	570×390×170 mm
Net weight	5,2 kg
Gross weight	6 kg
<b>Construction</b>	
Protection class	IP 43
<b>Communication interface</b>	
Communication interface	2×RS232, 2×USB-A, Ethernet, 4 IN / 4 OUT (digital), Wi-Fi
<b>Power supply</b>	
Power supply	Adapter: 100 – 240V AC 50/60Hz 1A; 15V DC 2,4A Balance: 10 – 28V DC 1A max
<b>Operating temperature</b>	
Operating temperature	+15 ÷ +30 °C
<b>Storage temperature</b>	
Storage temperature	-25 - +70 °C
<b>Relative humidity</b>	
Relative humidity	10% ÷ 85% RH no condensation

\* Wi-Fi® is a registered trademark of Wi-Fi® Alliance.



## Accessories

Antivibration tables  
 Transponder card readers  
 Power Adapters  
 RS 232 cables (scale - printer)  
 Cigarette lighter receptacle power supply cables  
 Barcode scanners  
 Under-pan weighing  
 RS 232, RS 485 cables  
 Label Printers  
 Additional modules  
 Displays

IN/OUT Cables  
 Keypad, external switches  
 Stands, wall mounting kits and mounting brackets  
 Receipt Printer  
 F1 Mass Standard - knob weights without adjustment chamber, set  
 AP2-1 Current Loop Unit  
 RS 232, RS 485 cables  
 Additional Weighing platforms Module  
 RS 232 – USB Converter  
 RS 232 cables (scale - printer)

## Software

- E2R Weighing [WX-010-0099]
- E2R Weighing Records [WX-010-0038]
- Audit Trail Reader [WX-010-0186]
- RADWAG Remote Desktop [WX-010-0107]
- RADWAG Development Studio [WX-010-0104]

- E2R Formulations [WX-010-0043]
- RAD Key [WX-010-0005]
- Label Editor R02 [WX-010-0094]
- Scale Editor - EWAG 2.1 [WX-010-0173]

# Device dimensions

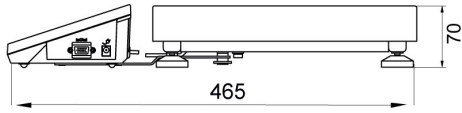

F1 version

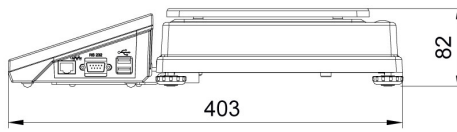
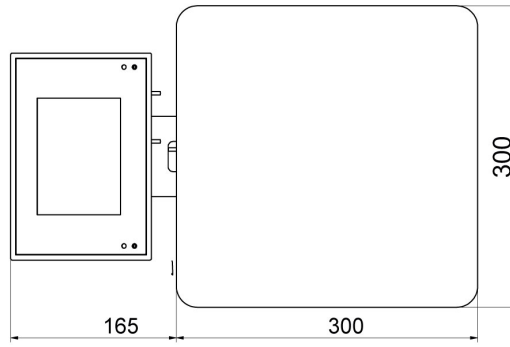

D2 version

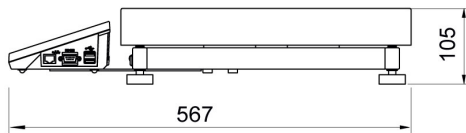
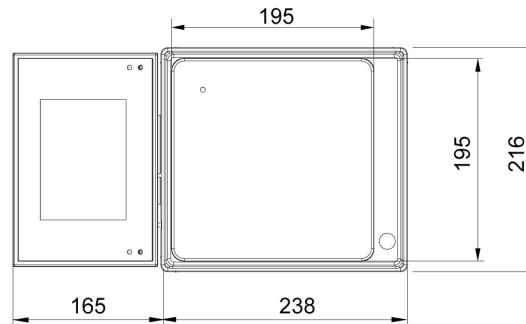

C2 version

